

# Development of Predictive Safety Management Methodology in Aviation

---

**Bartulović, Dajana**

**Doctoral thesis / Disertacija**

**2022**

*Degree Grantor / Ustanova koja je dodijelila akademski / stručni stupanj:* **University of Zagreb, Faculty of Transport and Traffic Sciences / Sveučilište u Zagrebu, Fakultet prometnih znanosti**

*Permanent link / Trajna poveznica:* <https://urn.nsk.hr/urn:nbn:hr:119:925182>

*Rights / Prava:* [In copyright / Zaštićeno autorskim pravom.](#)

*Download date / Datum preuzimanja:* **2024-07-23**



*Repository / Repozitorij:*

[Faculty of Transport and Traffic Sciences -  
Institutional Repository](#)





Sveučilište u Zagrebu

Faculty of Transport and Traffic Sciences

Dajana Bartulović

**DEVELOPMENT OF PREDICTIVE SAFETY  
MANAGEMENT METHODOLOGY IN AVIATION**

DOCTORAL DISSERTATION

Mentor: Prof. Sanja Steiner, PhD.

Zagreb, 2022



Sveučilište u Zagrebu

Fakultet prometnih znanosti

Dajana Bartulović

**RAZVOJ METODOLOGIJE PREDIKTIVNOGA  
UPRAVLJANJA SIGURNOSTI U ZRAKOPLOVSTVU**

DOKTORSKI RAD

Mentor: prof. dr. sc. Sanja Steiner

Zagreb, 2022.

## ACKNOWLEDGEMENTS

I would like to express my deepest gratitude to my mentor prof. Sanja Steiner, PhD. for her invaluable patience and feedback, as well as being my guide, not just during doctoral study programme, but also during my undergraduate and graduate study programme. I also could not have undertaken this journey without my Dissertation Defence Committee, who generously provided knowledge and expertise. Additionally, I could not have undertaken this journey without the support from my employer, Faculty of Transport and Traffic Sciences, who partly financed my research, via university project Innovative methods of risk prediction and objectification in aviation operational management. Also, I want to express my gratitude to my previous employers, where I gained invaluable knowledge, experience and operational expertise in the field of aviation safety management. Special thanks goes to Split Airport who provided actual safety performance data for this research, without whom this endeavour would not have been possible. Lastly, and most importantly, I want to express my gratitude to my family and friends, who provided me with motivation and emotional support, during this process.

## MENTOR'S INFORMATION

Prof. Sanja Steiner PhD. was born in 1964 in Zagreb. She completed graduate study of Air Transport in 1988, Master of Science degree received in 1995 at the Faculty of Maritime Studies of the University of Rijeka, and PhD received in 1998 at the Faculty of Transport and Traffic Sciences of the University of Zagreb. In 1997, she was awarded a DAAD scholarship for scientific specialization at the Institute of Aeronautics of the Technical University in Berlin. He has been permanently employed at the Faculty of Transport and Traffic Sciences of the University of Zagreb since 1988 and has been appointed Full Professor (for permanent) in 2010. She is engaged lecturer in the undergraduate and graduate studies of Air Transport and in scientific research. She is holder of the Strategic Transport Planning course at the postgraduate doctoral studies of Transport and Maritime Faculties in Zagreb, Rijeka and Sarajevo. She is head of the Air Transport Department at the Faculty of Transport and Traffic Sciences in Zagreb. She is vice president of the Scientific Council for Transport and director of the Transport Institute of the Croatian Academy of Sciences and Arts. She served as president of the Steering Committee of the Institute of Transport and Communications and the Supervisory Board of Croatia Control. She was a member of the Council of Croatian Civil Aviation Agency and member of the Master's Board of Technical Sciences – Fields of Mechanical Engineering, Naval Architecture, Traffic and Transportation Technology, Aeronautics, Rocket and Space Technology by the National Council for Science and Higher Education of Croatia. She has been a member of the Air Traffic Control Association since 1998 and a member of the Flight Safety Foundation since 2002, with three mandates being a member of the European Advisory Committee. From 2007 to 2013 she was a member of the Programme Committee for Transport incl. Aeronautics of the Seventh Framework Programme (FP7). She was a visiting scientist and professor at the technical universities and universities in Berlin, Bitola, Bucharest, Ljubljana, Russe and Sarajevo. She has published 6 textbooks and scripts. She has conducted four national scientific projects and a national scientific programme Harmonization of the Transport System in the Context of Sustainable Development, as well as several scientific projects within the Institute of Transport and Communications and the University of Zagreb. She has been participating in more than 90 scientific and professional conferences. She has published more than 200 scientific papers in journals and conference proceedings. She has participated in the organisational and programme committees of more than 30 scientific conferences and has edited over 10 books – conference proceedings. She is a member of the editorial and programme boards of 3 international journals in the field of transport.

## ABSTRACT

The implementation and maintaining of effective safety management system (SMS) is regulated on global, regional, and national level. SMS is regulatory obligation for every aviation organisation. Three safety management methodologies have been defined: reactive, proactive and predictive. Most aviation organisations apply reactive or proactive methodology; hence the improvement of safety management can be found in predictive methodology. Therefore, the research is focused on the development of predictive safety management methodology. Targeted analyses is performed regarding safety management methodologies, sources of hazard identification, safety performance indicators and the links between them are revealed. Based on the research, a conceptual model of predictive safety management is developed, which identifies future threats, and ensures possibility of earlier response and mitigation measures, with the purpose of improving overall organisation's safety performance.

Keywords: development, predictive, safety management, methodology, aviation

## SAŽETAK (PROŠIRENI)

Implementacija i održavanje učinkovitog sustava upravljanja sigurnošću (SMS-a) regulirana je na globalnoj, regionalnoj i nacionalnoj razini. SMS je regulatorna obveza svake zrakoplovne organizacije. U radu je definiran problem istraživanja, svrha i ciljevi istraživanja uz pregled dosadašnjih istraživanja vezanih uz problematiku metodologija upravljanja sigurnošću u zrakoplovstvu. Istraživanje uključuje analizu upravljanja sigurnošću u zrakoplovstvu, uključujući povijesni razvoj, funkcije i elemente upravljanja sigurnošću u zrakoplovstvu, sa sveobuhvatnim pregledom sustava upravljanja sigurnošću u zrakoplovstvu. Posebno je obrađen segment upravljanja sigurnosnim performansama, koji uključuje sustave prikupljanja i obrade sigurnosnih podataka, analizu sigurnosnih podataka (deskriptivna, inferencijalna, prediktivna, kombinirana), donošenje odluka na temelju podataka te sigurnosne ciljeve, pokazatelje sigurnosnih performansi, ciljeve sigurnosnih performansi i sigurnosne „okidače“. Rad detaljno analizira metodologije i primjenjive metode upravljanja sigurnošću u zrakoplovstvu. Definirane su tri metodologije upravljanja sigurnošću: reaktivna, proaktivna i prediktivna. Većina zrakoplovnih organizacija primjenjuje reaktivnu ili proaktivnu metodologiju, a prostor za poboljšanje upravljanja sigurnošću nalazi se u prediktivnoj metodologiji. Na temelju analize primjenjivih metoda izrađena je selekcija prikladnih metoda te je prikazan pregled prediktivnih metoda primjenjivih u upravljanju sigurnošću u zrakoplovstvu. Stoga, istraživanje je usmjereno na razvoj prediktivne metodologije upravljanja sigurnošću. Ciljano su analizirane metodologije, izvori identifikacije opasnosti, sigurnosni pokazatelji te su otkrivene korelacije između njih. Utvrđeno je kako proaktivna metodologija predstavlja nadgradnju reaktivne, dok prediktivna metodologija predstavlja nadgradnju proaktivne metodologije. Uporabom prediktivnih metoda i kauzalnog modeliranja izrađena je prediktivna analiza i kauzalni model pokazatelja organizacijskih i sigurnosnih performansi provedenih na uzorku zrakoplovne organizacije, što dokazuje da postoje odnosi među pokazateljima organizacijskih i sigurnosnih performansi u organizaciji, te otkrivanjem istih otvora se mogućnost saznanja koje pokazatelje povećati ili smanjiti kako bi se postigla željena razina sigurnosnih performansi u organizaciji. Na temelju istraživanja, razvijen je konceptualni model prediktivnoga upravljanja sigurnošću, koji omogućuje identifikaciju potencijalnih opasnosti, te posljedično mogućnost ranijeg reagiranja i definiranja mjera za ublažavanje, u svrhu poboljšanja sveukupnih sigurnosnih performansi organizacije. Validacija i verifikacija konceptualnog modela prediktivnoga upravljanja sigurnošću provedena je na uzorku Zračne luke Split, te je prikazan sažetak rezultata i prijedlog mjera za ublažavanje za Zračnu luku Split. Novo razvijeni konceptualni model prediktivnoga upravljanja sigurnošću predstavlja nadgradnju postojećih reaktivnih i proaktivnih metodologija upravljanja sigurnošću u zrakoplovstvu.

Ključne riječi: razvoj, prediktivno, upravljanje sigurnošću, metodologija, zrakoplovstvo

## TABLE OF CONTENT

<b>1 INTRODUCTION</b>	<b>1</b>
<b>1.1 Introduction and review of previous research</b>	<b>1</b>
<b>1.2 Aim and research hypotheses</b>	<b>3</b>
<b>1.3 Methodology and research plan</b>	<b>3</b>
<b>1.4 Expected scientific contribution of the proposed research</b>	<b>5</b>
<b>2 SAFETY MANAGEMENT IN AVIATION</b>	<b>6</b>
<b>2.1 Historical development of aviation safety management</b>	<b>6</b>
2.1.1 Safety concepts, functions, and aspects in aviation	6
2.1.2 Development phases of aviation safety management system	7
2.1.3 Comparison of traditional and modern approach to safety management	9
2.1.3.1 <i>Traditional approach to safety management</i>	9
2.1.3.2 <i>Modern approach to safety management</i>	11
2.1.3.3 <i>Comparison of traditional and modern approach to safety management</i>	12
<b>2.2 Concepts of accident causation in aviation</b>	<b>15</b>
<b>2.3 Safety management system as an operational tool to prevent accidents or incidents</b>	<b>18</b>
2.3.1 Definition of aviation safety management system	18
2.3.2 Aim and purpose of establishing an aviation safety management system	19
2.3.3 Regulatory and operational requirements of the aviation safety management system	20
2.3.4 Basic ICAO framework: components and elements of the aviation safety management system	21
2.3.5 Implementation of the aviation safety management system	22
2.3.6 Safety risk management and safety assurance – the core components of an effective aviation safety management system	26
2.3.6.1 <i>Safety Risk Management</i>	26
2.3.6.1.1 Hazard identification	28
2.3.6.1.2 Safety risk assessment and mitigation	29
2.3.6.2 <i>Safety Assurance</i>	33
2.3.6.2.1 Safety performance monitoring and measurement	34
2.3.6.2.2 Management of change	35
2.3.6.2.3 Continuous improvement of the safety management system	36
2.3.7 Overview of the aviation safety management system	36
<b>3 SAFETY PERFORMANCE MANAGEMENT</b>	<b>38</b>
<b>3.1 Safety data collection and processing systems</b>	<b>40</b>
<b>3.2 Safety data analysis</b>	<b>44</b>
3.2.1 Descriptive analysis	46
3.2.2 Inferential analysis	46
3.2.3 Predictive analysis	46
3.2.4 Combined analysis	47
<b>3.3 Data-driven decision-making</b>	<b>47</b>
3.3.1 Advantages of data-driven decision-making	48
3.3.2 Challenges with data-driven decision-making	48
3.3.3 Data-driven decision-making process	49
3.3.4 Safety performance management and data-driven decision-making	50



<b>3.4 Safety objectives</b> .....	<b>51</b>
<b>3.5 Safety performance indicators</b> .....	<b>52</b>
3.5.1 Qualitative and quantitative safety performance indicators .....	53
3.5.2 Lagging and leading indicators.....	53
3.5.3 Selection of safety performance indicators .....	55
<b>3.6 Safety performance targets</b> .....	<b>56</b>
3.6.1 Setting targets with high-level safety objectives .....	57
3.6.2 Setting targets with SMART safety objectives.....	57
<b>3.7 Safety triggers</b> .....	<b>59</b>
<b>4 AVIATION SAFETY MANAGEMENT METHODOLOGIES AND APPLICABLE METHODS</b> .....	<b>61</b>
<b>4.1 Basic aviation safety management methodologies</b> .....	<b>61</b>
4.1.1 Reactive safety management methodology.....	62
4.1.2 Proactive safety management methodology .....	63
4.1.3 Predictive safety management methodology.....	64
<b>4.2 Application of predictive methods in aviation industry</b> .....	<b>65</b>
<b>4.3 Types of analytical methods</b> .....	<b>70</b>
4.3.1 Descriptive statistics .....	71
4.3.2 Frequency histogram.....	71
4.3.3 Stem-and-leaf plots.....	72
4.3.4 Q-Q plots .....	73
4.3.5 Box plots .....	73
4.3.6 Tests of normality .....	74
<b>4.4 Types of predictive methods</b> .....	<b>74</b>
4.4.1 Forecasting in aviation.....	75
4.4.2 Overview of forecasting methods.....	75
4.4.2.1 <i>Trend projection</i> .....	76
4.4.2.2 <i>Nonseasonal exponential smoothing</i> .....	76
4.4.2.3 <i>Seasonal exponential smoothing</i> .....	79
4.4.2.4 <i>Moving average method</i> .....	81
4.4.2.5 <i>Auto Regressive Integrated Moving Average (ARIMA)</i> .....	82
4.4.2.6 <i>Econometric analysis</i> .....	83
4.4.3 Forecasting methods in air navigation services.....	84
4.4.4 Forecasting methods in airport operations.....	86
4.4.4.1 <i>Example of making a forecast using the trend projection</i> .....	87
4.4.4.2 <i>Example of forecasting using the decomposition method</i> .....	89
4.4.5 Unconstraining methods in airline operations .....	93
4.4.5.1 <i>Method that ignores the existence of censorship (I1 method)</i> .....	95
4.4.5.2 <i>Method that rejects censored values (I2 method)</i> .....	95
4.4.5.3 <i>Replace With Average (RWA) method</i> .....	96
4.4.5.4 <i>Replace With Median (RWM) method</i> .....	96
4.4.5.5 <i>Replace With Percentile (RWP75) method</i> .....	97
4.4.5.6 <i>Booking Profile (BP) method</i> .....	98
4.4.5.7 <i>Expectation Maximization (EM) method</i> .....	99
4.4.5.8 <i>Projection Detruncion (PD) method</i> .....	103
<b>4.5 Overview of predictive methods applicable in aviation safety management</b> .....	<b>107</b>
<b>5 CORRELATIONS BETWEEN AVIATION SAFETY MANAGEMENT METHODOLOGIES</b> .....	<b>110</b>

<b>5.1 Safety performance indicators as a bridge between safety management methodologies – theoretical overview .....</b>	<b>110</b>
<b>5.2 Case study: Liaison between proactive and predictive safety management methodology on the sample aviation training organisation .....</b>	<b>112</b>
5.2.1 Examples of application of reactive and proactive methodology in an aviation training organisation.....	112
5.2.2 Application of predictive methods in the safety management system of an aviation training organisation.....	118
<b>5.3 The liaison between reactive, proactive, and predictive safety management methodology .</b>	<b>123</b>
<b>6 PREDICTIVE ANALYSIS OF ORGANISATIONAL AND SAFETY PERFORMANCE INDICATORS .....</b>	<b>126</b>
<b>6.1 Link between causation and prediction: Theoretical overview .....</b>	<b>126</b>
6.1.1 Literature review .....	126
6.1.2 Link between causation and prediction .....	133
<b>6.2 Case study: Predictive analysis and causal modelling of organisational and safety performance indicators on the sample aviation training organisation .....</b>	<b>135</b>
6.2.1 Analysis of an organisation’s safety database .....	135
6.2.2 Analysis of organisational and safety performance indicators of an aviation training organisation using statistics methods .....	139
6.2.3 Forecasting of safety performance indicators of an aviation training organisation using predictive methods.....	144
6.2.4 Causal modelling of organisational and safety performance indicators of an aviation training organisation.....	148
6.2.5 Predicting safety performance indicators using predictive methods and causal modelling – scenarios and analyses .....	154
<b>7 CONCEPTUAL MODEL OF PREDICTIVE SAFETY MANAGEMENT IN AVIATION .....</b>	<b>160</b>
<b>8 VALIDATION AND VERIFICATION OF CONCEPTUAL MODEL OF PREDICTIVE SAFETY MANAGEMENT ON THE SAMPLE OF SPLIT AIRPORT .....</b>	<b>163</b>
<b>8.1 Analysis of Split Airport safety database .....</b>	<b>165</b>
<b>8.2 Causal modelling of Split Airport organisational and safety performance indicators .....</b>	<b>172</b>
<b>8.3 Outliers and root cause analysis of Split Airport safety performance indicators.....</b>	<b>179</b>
<b>8.4 Predictive analysis of safety performance: Forecasting of Split Airport organisational and safety performance indicators .....</b>	<b>201</b>
<b>8.5 Predictive analysis of safety performance indicators and causal modelling: Scenario cases for Split Airport.....</b>	<b>209</b>
8.5.1 Scenario 1 – Impact on safety performance indicators due to increase of aircraft operations .....	209
8.5.2 Scenario 2 – Impact on safety performance indicators due to decrease of aircraft operations .....	213
8.5.3 Scenario 3 – Impact on safety performance indicators due to increase of number of passengers.....	216
8.5.4 Scenario 4 – Impact on safety performance indicators due to decrease of number of passengers.....	219
<b>8.6 Expanded set of safety performance indicators for Split Airport .....</b>	<b>222</b>
<b>8.7 Summary of results and proposal of mitigation measures based on predictive safety management methodology for Split Airport.....</b>	<b>230</b>

<b>9 CONCLUSION</b> .....	<b>245</b>
<b>REFERENCES</b> .....	<b>251</b>
<b>LIST OF TABLES</b> .....	<b>272</b>
<b>LIST OF FIGURES</b> .....	<b>275</b>
<b>LIST OF ABBREVIATIONS</b> .....	<b>279</b>
<b>AUTHOR’S CURRICULUM VITAE AND LIST OF PUBLISHED WORK</b> .....	<b>282</b>

# 1 INTRODUCTION

## 1.1 Introduction and review of previous research

Safety management systems have made a large contributions to aviation safety since the first introduction in the field. Today every aviation organisation has the obligation to implement Safety Management System (SMS) and actively record and report every occurrence (hazard) that happens or potentially could happen in the organisation. Development of the aviation system and growth of air traffic require the introduction of advanced safety capabilities that increase capacity while maintaining or enhancing operational safety and managing existing and emerging risks more efficiently.

On the global level, International Civil Aviation Organisation (ICAO) prescribes 19 Annexes to the Convention on International Civil Aviation of Standard and Recommended Practices (SARPs) among which Annex 19 (ICAO, 2016) brings rules and regulations regarding Safety Management and issues ICAO Safety Management Manual (ICAO, 2018) as a guide for each member state to implement State Safety Programmes on the national level and Safety Management Systems within each aviation organisation. On the territory of European Union (EU) the duty of rulemaking is delegated to European Union Aviation Safety Agency (EASA). EASA issues regulations regarding safety reporting and accident investigation as well as general regulations on implementing safety management systems in the organisations within the territory of EU.

SMS is a formal organisational system that integrates active safety management tools, including safety risk management, safety reporting, audits, investigations and remedial actions, safety culture and education supported by clear policies and processes (ICAO, 2018). Effective SMS must have four main components in place in order to work properly and efficiently. Those four components include safety policy, safety risk management, safety assurance and safety promotion. The second component is Safety Risk Management (SRM), and it is the core of efficient SMS. It deals with occurrence (hazard) identification, risk assessment and risk mitigation (ICAO, 2018) (Čokorilo, et al., 2011). Hazard identification is the part of SRM process used to identify hazards (Čokorilo & Dell'Acqua, 2013) (Jakovljević, et al., 2017) (Velazquez & Bier, 2015). Risk assessment is an evaluation based on engineering and operational judgement or analysis methods in order to establish whether the achieved or perceived risk is acceptable or tolerable (Ferguson & Nelson, 2014) (Cusick, et al., 2017) (Steiner, 1998). If the risk is unacceptable, risk mitigation, i.e., control measures are taken to increase the level of defences against that risk or to avoid or remove the risk (Steiner, et al., 2018) (Oster Jr., et al., 2013). The third component is Safety Assurance (SA), and it includes safety performance monitoring and measurement, management of change and continuous improvement of SMS (ICAO, 2018) (Stolzer & Goglia, 2015) (Adjekum, 2014). Modern approach of safety management prefers proactive approach, and available data collection and analysis tools allows making predictions that provide a closer look at the previously identified high-risk areas and provide the ability to detect future risks.

Three main methodologies in aviation safety management are: reactive, proactive, and predictive (ICAO, 2018) (Miroslavić, et al., 2008) (Oster Jr., et al., 2013) (Steiner, et al., 1998). All three methodologies are closely linked to two key SMS components mentioned above: safety risk management and safety assurance. The SMS needs input data to be able to provide viable results and these methodologies are the SMS tool that enables it to acquire necessary safety data (Burin, 2013). Reactive methodology gathers safety data from the accidents and incidents that has already occurred in the past and learns from their outcomes (Ancel, et al., 2015) (Čokorilo, et al., 2019). Proactive methodology uses safety reporting systems and safety performance indicators to gather safety data in order to discover and mitigate the potential threats and hazards that may consequently trigger the occurrence of accident or incident (ICAO, 2018). Predictive methodology is not yet well established, as it assumes discovering potential and possible hazards based on predictive analyses (forecasts) that extract information from historical and current safety data and use it to predict trends and behaviour patterns (Ancel, et al., 2015) (Čokorilo, et al., 2019) (ICAO, 2018) (Luxhøj, 2013) (Stanton, et al., 2008) (Hsiao, et al., 2012) (Hsiao, et al., 2013) (Bartulović & Steiner, 2020) (Boeing, 2012).

Predictive methods can use safety data from mandatory occurrence reporting, voluntary occurrence reporting, data obtained by measuring safety performance (SPIs and SPTs) and data obtained from predictive analyses (forecasts) that extract information from historical and current safety data to predict trends and behaviour patterns of emerging hazards. For example, ICAO (ICAO, 2013) has begun to put in place significantly improved and expanded online access to real-time safety information through its Integrated Safety Trend Analysis and Reporting System (iSTARS) initiative, as well as a range of additional aviation data, to support the implementation of the evolving approach to safety management. Boeing has developed sophisticated technologies that provide distinct safety advantages, such as: Vertical Situation Display, predictive windshear equipment along with improved windshear – training programs for pilots, and Enhanced Ground Proximity Warning System (Boeing, 2012). Airbus uses Flight Data Analysis (FDA) programs which extract data from easily accessible recorders and customize the recorded parameters to make predictive analyses, which are used to find current or future irregularities (Airbus, 2014). Pisanich and Corker (Pisanich & Corker, 1995) described a model of pilot performance in interaction with varied levels of automation inflight management operations, which was used to predict the performance of a two-person flight crew responding to clearance information. Roelen and others (Roelen, et al., 2016) conducted a study on an integrated approach to risk modelling in which the total aviation system, and human factors and cultural aspects are considered in connection with technical and procedural aspects and with emphasis on representation of emerging and future risks. Khoshkhoo (Khoshkhoo, 2017) developed a proactive and predictive method in safety management system that detects the capabilities and pitfalls of dispatcher performance.

Predictive systems do not require the occurrence of a triggering event to launch the safety data capture process. Routine operational data are continuously collected in real time (Brockwell & Davis, 2016). Predictive systems are based on the notion that safety management is best accomplished by trying to identify a problem instead of simply waiting for something to happen. Therefore, predictive safety systems aggressively seek safety information that could be indicative of emerging safety risks from a variety of sources.

Predictive SMS methodology can use historical and current safety data, Safety Performance Indicators (SPIs) and Safety Performance Targets (SPTs) of an organisation as input information to conduct predictive analysis, i.e., make forecasts using predictive (forecasting) methods. The obtained results show trends and behaviour patterns of established SPIs in the organisation and give a clearer view of the future development of an organisation's safety performance, while simultaneously identifying emerging hazards (Bartulović, 2021).

The main objective of the research is development of a predictive safety management methodology in order to improve the safety performance of aviation organisations. The research strives to identify sources of hazard identification, expand the set of safety performance indicators, identify causal links between organisational and safety indicators, and identify correlations between safety management methodologies. For the purposes of this research, actual safety data from aviation organisations were used to make analyses and present the above-mentioned correlations. By developing a conceptual model of predictive safety management, hazards that may arise in the future can be identified, which ensures earlier response and definition of mitigation measures, and facilitates planning of future actions with the purpose of improving the overall safety performance of the organisation.

## **1.2 Aim and research hypotheses**

The aim of the research is development of a conceptual model of predictive safety management in aviation based on defined elements, correlations, indicators, and application of predictive methods, which are the result of analysis of existing safety management methodologies.

Working hypotheses of the doctoral dissertation:

- H1. existing safety management methodologies are inadequate, and upgrading safety management with predictive methodology could improve safety management in aviation organisations,
- H2. by developing predictive safety management in aviation, hazards that may arise in the future could be detected and identified, which would ensure earlier response, mitigation measures, and continuing maintenance of an acceptable level of safety in aviation organisations.

## **1.3 Methodology and research plan**

According to the hypotheses of the doctoral dissertation, considering the continuous growth of air traffic and development of aviation system, the existing safety management methodologies need to be improved and upgraded. In most aviation organisations, reactive safety management methodology is used, while some organisations also use proactive safety management methodology.

Various examples of the application of predictive methods in aviation can be found in individual segments of the aviation system, with the purpose of conducting safe operations, but none in a segment of safety management. The predictive methodology in the safety management segment is not yet established nor it is clearly defined. The idea was to develop a predictive safety management methodology and based on that, develop a new conceptual model of predictive safety management, which would be an upgrade of the existing reactive and proactive safety management, and which would ensure more efficient collection and analysis of safety data, as well as easier and improved hazard identification process. Predictive methodology uses predictive methods to identify existing and potential hazards based on predictive analyses (forecasts) that extract information from historical and current safety data to predict trends and behavioural patterns of emerging or potential hazards.

In addition to conceptualizing predictive safety management methodology, the research aimed to prove the possibility of upgrading the existing methodologies with predictive one and the application of a combination of all methodologies, instead of introducing and applying each one individually. The research is focused on detecting correlations between safety management methodologies and correlations between organisational and safety performance indicators on the sample of aviation organisations. By identifying these correlations, detecting causal factors, and using predictive methods, it is possible to improve safety management processes in aviation organisations. By applying a predictive safety management methodology, it is possible to identify organisational deficiencies and future risks, in terms of safety performance, and work to improve them, in order to increase the level of safety in an organisation.

The research is conducted in five phases, where existing predictive methods applicable in the safety management segment were thoroughly analysed, using scientific methods such as inductive and deductive method, analysis and synthesis method, generalization and specialization method, proof method, classification method, description method, compilation method, comparative method, statistical method, mathematical method, modelling method and experimental method. Analysed predictive methods are time series analysis methods such as trend projection, simple exponential smoothing, exponential smoothing method with trend and seasonality, Holt-Winter method (additive and multiplicative), moving average method, and autoregressive integrated moving average modelling (ARIMA).

The first phase defines the research problem, purpose, and research aim with an overview of previous research, sets hypotheses of the research, defines methodology and research plan and states the expected scientific contribution of the proposed research.

In second phase, the topic of aviation safety management, from the historical development of aviation safety management and accident causation models to the development and implementation of safety management system (SMS) as an operational tool for accident prevention and risk mitigation in aviation, is covered. Furthermore, the topics of hazard identification and safety performance management is covered, including safety data collection and processing systems, types, and methods of data analysis, setting and defining safety objectives, monitoring and measuring safety performance through safety performance indicators and targets, and correlating safety performance management with the concept of data-driven decision making. The basic methodologies of aviation safety management are

analysed in detail, as well as the types of analytical and predictive methods, with an overview of the current use of predictive methods in aviation.

The central third phase of the research includes the analysis and determination of correlations between safety management methodologies on the sample aviation organisation, and the term correlation of causality and prediction. Correlation links between organisational indicators and safety performance indicators are determined, as well, on the sample aviation organisation, by developing models of mutual influences (causes and consequences) and applying appropriate predictive methods.

In fourth phase, a conceptual model of predictive aviation safety management is developed and described. IBM SPSS Statistics software package, as well as other suitable software tools, were used to create statistical analyses, forecasts, causal models, and simulations.

The final fifth phase tested and verified the conceptual model of predictive safety management on the sample of actual safety data, organisational data and safety performance indicators in aviation organisation, i.e., airport operator. With the purpose of showing improvement of overall safety management in the aviation organisation, i.e., airport operator, and for testing and verification of proposed conceptual model, proposed conceptual model is used to measure safety performance, create forecasts, detect causal relationships between indicators, simulate scenarios, as well as to provide the proposal of mitigation measures.

#### **1.4 Expected scientific contribution of the proposed research**

Based on the hypotheses set, defined aim and results of the proposed research, the following scientific contributions were expected:

1. defining an expanded set of organisation's safety performance indicators,
2. conceptual model of predictive safety management in aviation.



## 2 SAFETY MANAGEMENT IN AVIATION

### 2.1 Historical development of aviation safety management

Since the beginnings of the aviation development, it has been clear that it is associated with known and unknown risks. Acceptance of a certain degree of risk is a necessary precondition for performing any activity, including flying (Steiner, 1998).

A sustainable approach to safety comes down to reducing risk through the detection of hazards, initially through direct observation and later through experiential learning. This approach has been applied since the very beginning, while the first beginnings of systematic collection of experiences at the global level were recorded in 1919, when the International Air Convention was signed and ratified in 38 countries. As a result of that Convention, the first international aviation organisation was established, i.e., International Air Navigation Commission (CINA<sup>1</sup>) based in Paris. The Convention contained only four objectives, of which two were „to collect reports from Member States“, and „to transmit the collected information to Member States“ (Steiner, 1998).

The obligation to collect safety-related data was further elaborated by the Convention on Civil Aviation (ICAO, 2006), signed on December 7, 1944, in Chicago, USA. Article 26 of the Convention, binding on the current 193 members, imposes an obligation on the State in which the accident occurred to establish and, within the framework of international standards, investigate the causes of the accident (ICAO, 2005) (ICAO, 2007). Furthermore, Article 37 states that the standards and recommended actions related to the investigation are prescribed in Annex 13 to the Convention (ICAO, 2016). Annex 13 states that the goal of the investigation is accident prevention, but not the assignment of guilt or responsibility.

#### 2.1.1 Safety concepts, functions, and aspects in aviation

The concept of safety should be understood very broadly: from correctness in performing very complex tasks of the aviation organisation, through proper handling and maintenance of equipment to protection from conscious and unconscious actions that endanger the normal air traffic operations.

The notion of air traffic safety is a very complex set of phenomena within the air traffic system that are interconnected in a unique and very complex way (interaction of human, aircraft and environmental factors) (Helmreich, 1998) (Nagel, 2006) (Gilliam, 2019). All procedures in the aspect of aviation safety are reduced to four basic categories:

- hazard anticipation,
- hazard detection,

---

<sup>1</sup> Commission Internationale de Navigation Aérienne

- accident prevention,
- eliminating or mitigating the consequences of an incident or an accident (Steiner, 1998).

The hazards for a dynamic system arise at the time of the realization of the technological process; for the air transport system, the hazards most often appear in the transport phase (flight). The air transport technological process is a managed transport process, divided into three phases: the preparatory phase, the realization phase, and the final phase. The management process implies the coordination of all its elements, hence the system goes through the permitted (safety) conditions, which is achieved by protection, regulation, and control, where feedback is the basic principle of management. Therefore, an analytical analysis of individual aspects of safety logically follows, and general aspects of safety can be distinguished: technical, technological, and organisational. In the most general sense, the technical aspect of safety means the suitability of technical means (means of transport and transport infrastructure) for the realization of the technological process, i.e., the permissible state of technical means in the management process. The technological aspect of safety is broader and more complex than the technical aspect due to the technological transformation of the system from static to dynamic, and the connection of all elements of the system in different relations (Goetsch, 2008). The organisational aspect of air traffic safety in the narrower sense, i.e., in the function of the realization of the technological process, represents the spatial and temporal synchronization of several subjects and activities into a single continuous process. Given that the disruption or inconsistency of certain phases and activities can, directly or indirectly, negatively affect the state of the system, it is justified to give the organisation as a management concept a dimension of „safety“. Organisational aspect in a broader sense includes protection, regulation and control of elements of the technological process and those factors that are not directly involved in the technological process, but on which it indirectly depends, such as education and training of professionals, unification of relevant conditions through legal norms, etc., or those factors that limit the technological process in such a way that it must take place within the set conditions, such as environmental criteria of exploitation, protection from air pollution, noise, visual degradation of space, etc.

On the other hand, the transport system, especially air transport, is not spatially limited, but has a global character, so there is a logical need for standardization and unification of rules on a larger scale, which is again achieved by legal regulations.

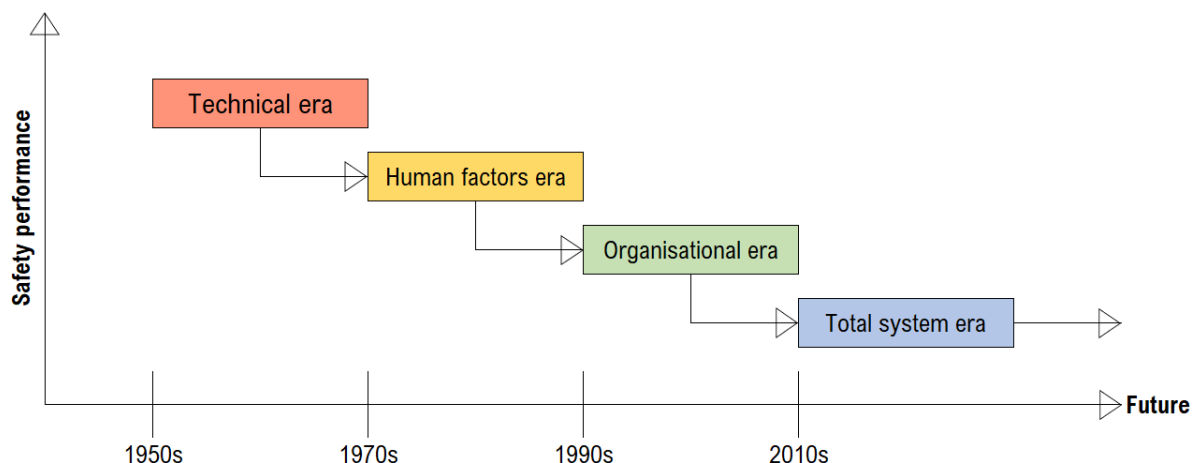
### 2.1.2 Development phases of aviation safety management system

According to (ICAO, 2018), the historical development of the safety management (shown in Figure 1) in aviation can be divided into four phases:

- Phase of influence of technical factors: focus was on technical improvements in a period when most of the risks had arisen from technical imperfections of aircraft and ground equipment; this phase ended with the replacement of the piston engine with jet engine, from the 1960s to the early 1970s;

- Human impact phase: focus on human factors in aviation, when technical methods have been replaced by behavioural psychology in an attempt to reduce the number of end-operator errors in the system; this phase gradually began as the previous one ended and, in most socio-technical systems it still lasts (other transport branches, medicine, occupational safety, etc.), while in aviation it gradually vanishes from the end of the 1990s onwards;
- Phase of influence of organisational factors: focus was on organisational factors which deal with the management of the organisation as a whole, in an attempt to create a system that anticipates and preventively eliminates deficiencies or errors of end operators or eliminates their consequences;
- Phase of creating a total system: a total system safety approach considers the entire aviation industry as a system. All service providers, and their systems for the management of safety, are considered as sub-systems. This allows a State to consider the interactions, and cause and effect, throughout the whole system. It is often impossible or impractical to build all safety systems in the same way. Therefore, a primary concern for States and service providers is how to best manage the interfaces between dissimilar interacting systems. For the collaborative total system approach to flourish, interfaces and interactions between the organisations (including States), need to be well understood and managed. States are also beginning to recognize the role the total aviation system approach can play in their State Safety Programme (SSP) development. For example, it helps to manage safety risks which cut across multiple aviation activities.

Figure 1 shows the phases (eras) of the impact of various factors (technical, human, organisational, combined) throughout history of the development of aviation safety management.



**Figure 1 The evolution eras of safety management**

*Source: Author according to (ICAO, 2018)*

## 2.1.3 Comparison of traditional and modern approach to safety management

### 2.1.3.1 Traditional approach to safety management

A reactive or traditional aviation accident investigation system is limited to those events that resulted in loss of human life or significant material damage. The system is therefore investigated and repaired only after the accident has occurred, which is why it is called reactive. A reactive (either retroactive or traditional) safety management is based on the principle of trial and error, where „trial“ means an operation and „error“ means an accident. The basic principle of operation is the collection of data after the accident, from which conclusions are drawn about the cause or causes of the accident. These conclusions are then translated into recommendations to eliminate the cause of the accident, thus preventing its recurrence. The most significant limitations of reactive system are:

- at the level of an individual system:
  - insufficient scope of investigation,
  - questionable accuracy of the obtained information,
  - untimely detection of the cause, and
  - great dispersion of events;
- globally:
  - great dispersion of events, and
  - untimely detection of the cause.

A reactive safety management system is concentrated on compliance with normative practice. The need for management structures to maximize the productivity function most often leads to minimizing the safety function to the regulatory minimum.

The events from which such a system derives data are limited to accidents and significant incidents, which do not necessarily contain useful information, such as some minor incidents. Data collection is difficult because some of the equipment is likely to have been destroyed and witnesses are either deceased or, fearing responsibility, biased.

The results of the investigation are mostly focused on operator error or lack of equipment (active works), while „root“ deficiencies in the system (errors in management and monitoring, inadequate equipment design, etc., i.e., latent conditions) are given little attention or not the subject of investigation at all. The investigation is conceived in such a way that the cause-and-effect chain of events is investigated from the moment of the accident until the behaviour that did not bring the desired results. At that point, a conclusion is usually made about human error (Maurino, 1999).

Furthermore, in the event of an aircraft crash, great attention from the media and the public is essential. As a rule, culprits and a simple, understandable explanation are sought in an unprofessional and biased manner. This results in political pressure on the investigation team to complete the investigation as soon as possible and find the „culprit“, which clearly shows the

tendency to conclude the investigation as soon as the first (active) errors are discovered, and before the real (latent conditions) causes are found.

Every safety event is the result of a number of system weaknesses. These weaknesses can be certain characteristics of the organisation, technical deficiencies, unfavourable environmental conditions, errors of participants in the process, etc. The investigation following the accident reveals a number of weaknesses in the system, each of which contributed to the accident. Excluding any weakness of the system would eliminate the preconditions for an accident. What most of these weaknesses have in common is that they did not occur at the time of the accident but were present in the significant period that preceded the accident. Thus, the weaknesses could have been remedied even before the accident occurred. A reactive safety management system detects the causes after an accident has occurred, thus missing an opportunity to avoid it.

The occurrence of an accident in order to detect its causes in most modern socio-technical systems is not an acceptable price, both for regulators and users, and for system owners.

The number of events that the traditional safety management system deals with is relatively small, geographically dispersed through systems that differ according to available human and technical resources, and organisational, cultural, climatological, and operational environments. Therefore, the conclusions of aviation accident investigations are:

- sporadic,
- statistically inoperable,
- poorly relevant or irrelevant.

Modern air transport is subject to relatively frequent and radical changes in all segments. These changes relate not only to technical and technological development, but also to changes in the market (emergence of low-cost companies) and regulatory environment.

Any change in a complex socio-technical system, such as air transport, will cause a series of changes and interactions in individual segments of the system, which are often hard to predict. The fact that most of the changes are in the domain of the human factor, whose „creativity“ in creating new types of errors is unlimited, also contributes to unpredictability. In this way, latent weaknesses of the system arise, which have the long-term potential to lead to an accident, and therefore it is necessary to detect and eliminate them as soon as possible.

The reactive safety management system is constantly lagging behind the ongoing development of aviation system. Given the described shortcomings, it is evident that the possibilities of the traditional safety management system are more or less exhausted. While compliance with laws and regulations remains a cornerstone of global safety, there is a need to upgrade to proactive and predictive systems based on risk management.

### *2.1.3.2 Modern approach to safety management*

Leading operators during the eighties and nineties of the twentieth century, were trying to find measures to further improve safety, whose basic feature is a proactive way (as opposed to reactive). Among the most important, proactive measures are:

- application of scientifically-based risk management methods,
- commitment to the highest levels of safety management,
- a company culture of safety that encourages safety practices, encourages communication, and actively manages safety, paying equal attention to safety results as well as financial results,
- effective implementation of standard operating procedures,
- organisational environment that avoids punishment, in order to promote the efficiency of reporting,
- safety data collection, analysis, and distribution systems,
- conducting investigations in such a way as to primarily uncover systemic errors (rather than put blame on individuals),
- integration of safety-related topics into operational staff training,
- sharing knowledge about problems and solutions found between companies and countries, and
- systematic monitoring and measurement of the level of safety for the purpose of continuous monitoring and correction of negative trends.

According to the ICAO Safety Management Manual (SMM) (Doc 9859), safety management in the aviation industry is a combination of the two perspectives previously described, traditional and modern (ICAO, 2018).

A reactive (or traditional) approach to safety management is useful when it comes to technological failures or unusual events. The following features are usually described: meeting minimum safety requirements, and the level of safety is based on reported safety occurrences along with its inherent limitations (such as examining current failures, lack of data to identify safety trends, lack of insight into the causal chain, and the existence and role of latent conditions).

A proactive approach to safety management is based on safety risk management strategies that include identifying hazards before an accident or incident occurs and taking the necessary actions to reduce safety risks. The components of a proactive safety management strategy are: unambiguous senior management safety policy, hazard identification and risk assessment using risk assessment methods, safety reporting systems to collect, analyse and share operational safety-related data, safety investigation solely for the purpose of identifying systemic safety deficiencies, safety oversight, assessment of safety performance, elimination of problem areas, safety training of staff, distribution and exchange of best practices between operators and service providers, building a corporate safety culture that promotes good safety practices and communications.

Individual components do not meet expectations of improved aviation safety management. Integrated use of all components increase the system's resilience to unsafe activities and conditions. Harmonious integration of proactive safety management components has become a core part a safety management system (SMS). The development, role and importance of safety management have led to the gradual application of safety management systems by aviation organisations (airlines, air navigation service providers, airport operators) in last couple of decades.

This process is managed and supervised by the state through state safety programmes in accordance with ICAO recommendations. Improving corporate safety performance through proactive safety management is increasingly recognized in all aviation sectors as a prerequisite for sustainable business management and operational development.

### *2.1.3.3 Comparison of traditional and modern approach to safety management*

Throughout the history of development, safety has increased with the adoption of new standards, regulations and rules with a tendency to cover as many areas in aviation with rules so that the coincidence factor is eliminated as much as possible, and more standards and rules are introduced. The standards are aimed to ensure a certain level of safety, so in fact nothing more is expected of the participants than to adhere to them and this has been enough throughout history to reduce the risk. If a new problem arose, only a new regulation would be introduced, the introduction of which would solve the problem. Such a system functioned until the 1970s. Then began a period when the number of accidents increased, that is, the level of safety began to decline significantly, despite the growing number of regulations. This, already-mentioned methodology, is called „reactive“ because it is based on a predetermined standard that had to be followed, and any action of safety management was reactive, which means that the action was taken only when there was a deviation from the standard and sanctions (which often ended in an accident), which would often be followed by the adoption of new regulations.

In order for safety management to keep the risk at the lowest possible level in the conditions of constant growth of the aviation system, it switched from „reactive“ action to „proactive“. This simply means that safety management acts before any serious deviation (error) occurs. This methodology, unlike the reactive one, which is based on ICAO Standards and Recommended Practices (SARPs), considers many more factors, parameters, requires much more research work and principles of work. This methodology does not abolish SARPs but complements it, and successful implementation requires the following:

- introduction of scientifically established risk management methods;
- safety management should have the strong support of senior management;
- introducing a safety culture into everyday practice, supporting any activity and any communication that can lead to increased safety;
- practical introduction of standard operating procedures (SOPs), which include checklists and group consultations or group information;

- a working atmosphere where data and parameters are collected without sanctions;
- systems for collecting, processing and sharing confidential data collected during routine operations;
- systematic investigation of accidents and incidents based on objectivity and not aimed at determining the culprit;
- introduction of safety training for operational staff, as well as familiarization of staff with the human factors;
- exchange of information on methods and procedures in safety management between operators and countries;
- systematic monitoring of all systems involved in safety management in order to better implement and monitor safety performance indicators.

A clear indication that an error has occurred in the safety management system is an accident. As the modern safety management system strives to minimize the probability of an accident, it would be illogical to wait for it to occur. This requires a link between incidents and accidents, which means that understanding that link, is crucial for modern safety management (Leveson, 2017) (Ferjencik, 2011) (Ferjencik, 2014).

Traditionally, accident investigators have searched for a chain of events or circumstances that ultimately led to some error that caused the accident (Svedung & Rasmussen, 2002) (Hale, et al., 1997) (Ford, et al., 1999) (Kinnersley & Roelen, 2007). This error could have been the result of a misjudgement, misinterpretation of the rules, or a vague task (Dien, et al., 2012). The next traditional approach is that accident investigators often had priority to discover the culprit, and safety management was tasked with reducing the risk of such a mistake recurring (Vanderhaegen, 2010) (Wiegmann & Shappell, 2003) (Erjavac, et al., 2018) (Shappell, et al., 2009) (Gui, 2013) (Lee & Chung, 2018) (Wiegmann & Shappell, 2001) (Yuingyang & Gui, 2018). Despite the efforts, the mistakes that resulted in the accident continued to reoccur. In the end, it was concluded that such a system is inadequate. An analysis of the data after the accident showed that it was only a matter of time before it happened (Hollnagel, 2004) (Pasman, et al., 2018). It would often be concluded that experienced, well-trained and well-equipped staff made the mistake that caused the accident. It was found that he/she and his/her colleagues made this and similar mistakes quite often but without tragic consequences (Fogarty & Shaw, 2010) (Gui, 2013) (Stemn, et al., 2018). They created precarious conditions with little chance of an accident. However, the „time“ factor was neglected. The probability of an accident grows over time. The management, even if they knew about such offenses, thought that the probabilities were too low and would focus on some other problems. It is also true that such errors in operational staff or flight personnel are very difficult to detect because they are significantly more numerous than managerial staff. To change this, the SMS is introduced that takes a different approach with a different understanding.

The safety concept of protection, regulation and control presupposes a systematic approach in defining all elements of the system, standardizing regulatory mechanisms, quantifying safety minima of operation and exploitation, and positioning a multilevel process of control and prevention.



Systems such as SMS should include programmes to test safety levels, promote safety, as well as accidents, incidents and emergencies indicators. SMS relates to flight crew as its subsystem should also contain all these programmes. Successful operation of the system is possible only if it is based on accurate and real information. To ensure this, the SMS must contain at least:

- defined safety limits,
- ensured appropriate actions that keeps the risk below the defined safety limit,
- ensured appropriate risk monitoring measures due to possible risk growth.

For each system, it is important to determine the parameters according to which it will be possible to assess whether the system is functioning as expected, and if there is a deviation, to immediately define the reasons for the deviation. There are three types of parameters for systems such as SMS:

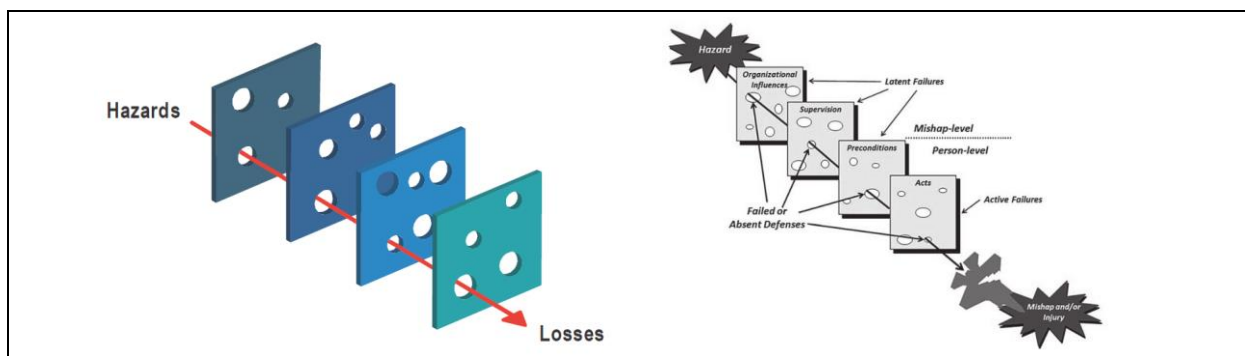
- Safety Performance Indicators (SPIs) which represent measures of safety performance primarily in the aviation industry; such indicators should be easily measurable and easily embedded in state safety programmes included in the SMS implemented and monitored by the competent aviation authority; safety performance indicators vary by industry, thus the indicators for air operators differ from those for airport services and air traffic control services;
- Safety Performance Targets (SPTs) relate to raising the quality and safety of individual services; these targets should be realistic, economically acceptable, and approved by the competent aviation authority;
- Safety requirements are requirements that apply to everything that is needed, to meet safety objectives and that is indicated by safety performance indicators; these requirements include operations, technologies, systems and programmes that measure reliability, availability, performance and accuracy, and are necessary to further increase the quality and safety of air transport.

Today, safety management is unthinkable without a system for monitoring hazardous and potentially hazardous events. Such systems are the foundation, and their use has contributed not only to safer flight but also to the overall improvement of air transport services. This system is of great benefit to the management, especially for the improvement of staff work and technical development of the company. It has proved particularly useful in obtaining information that is usually much more difficult to obtain through the chain of command. The staff in charge of collecting such information, whether pilots, mechanics or airport staff, now find it much easier to provide it to the competent authorities. This has been achieved by clearly defining offenses and by a system that records offenses independently of the staff. So now the management gets clear and much more accurate data from the field. This gives them a much better insight into the problem in a much shorter time, which, as expected, shortens their reaction time and contributes to a much faster solution to the problem.

## 2.2 Concepts of accident causation in aviation

The fact that accidents occur as a result of the simultaneous occurrence of several causes, among which the majority are latent conditions (states) and the minority active failures, allows a graphical representation of the trajectory of the accident occurrence (Hulme, et al., 2019) (Akyuz, 2017) (Lenne, et al., 2012) (Reason, 1990) (Rashid, et al., 2013) (Cacciabue, 2004) (Grant, et al., 2018).

Different levels of management, design, and operating environment can be visualized as surfaces, in which latent states are openings that allow the chain of events that will cause an accident to progress (Roberts & Bea, 2001). It is also possible to visualize the action of the operator as surfaces, in which the active acts are further openings (Zhou & Lei, 2017). Finally, defence systems are further surfaces set up precisely for the purpose of breaking the chain of events. Unfortunately, defence systems are also prone to design flaws or lack of performance, which can be re-visualized as openings in surfaces. The resulting model, i.e., „Swiss Cheese Model“ is shown in Figure 2.



**Figure 2 Concept of accident causation – James Reason's Swiss Cheese Model**

*Source: (ICAO, 2018)*

Figure 2 is a simple and common view of the scheme first published in James Reason's book, which is often referred to as the Reason Model (Reason, 1997). The original model emphasizes the claim that the active acts (errors and violations) of the operator are only the result of latent conditions of the organisation (Reason, 2008) (Reason, 1995). The direction of the investigation is also visible, which first reveals active acts and omissions in defence mechanisms, and latent conditions in the organisation and management decisions are discovered eventually (or not at all, contenting with blaming the end operator).

The latent conditions involved in the causation chain of an accident are present long before the accident itself, and several hundred times manifest themselves only as incidents, without significant damage (Reason, 1991). In the accident model, this can be shown as the absence of an opening on one of the surfaces, thus breaking the accident chain.

In aviation incidents, injuries and damage are generally less significant than in aviation accidents. Therefore, less publicity is associated with these events. As a rule, more information is available (e.g., live witnesses and undamaged flight data recorders). Thus, incidents are a better opportunity to identify why an incident occurred and how it was prevented from becoming an accident.

According to (ICAO, 2018) (Snook, 2000), Snook's theory of practical drift is used to understand how performance of any system „drifts away” from its original design. Tasks, procedures, and equipment are often initially prepared and planned in theory, under ideal conditions, with the explicit assumption that almost everything can be foreseen and controlled and where everything works as expected. In reality, this is not the case.

These ideal conditions are usually based on three fundamental assumptions where:

1. technology needed to achieve the system production goals is available,
2. personnel are trained, competent and motivated to properly operate the technology as intended, and
3. policy and procedures will dictate system and human behaviour (ICAO, 2018).

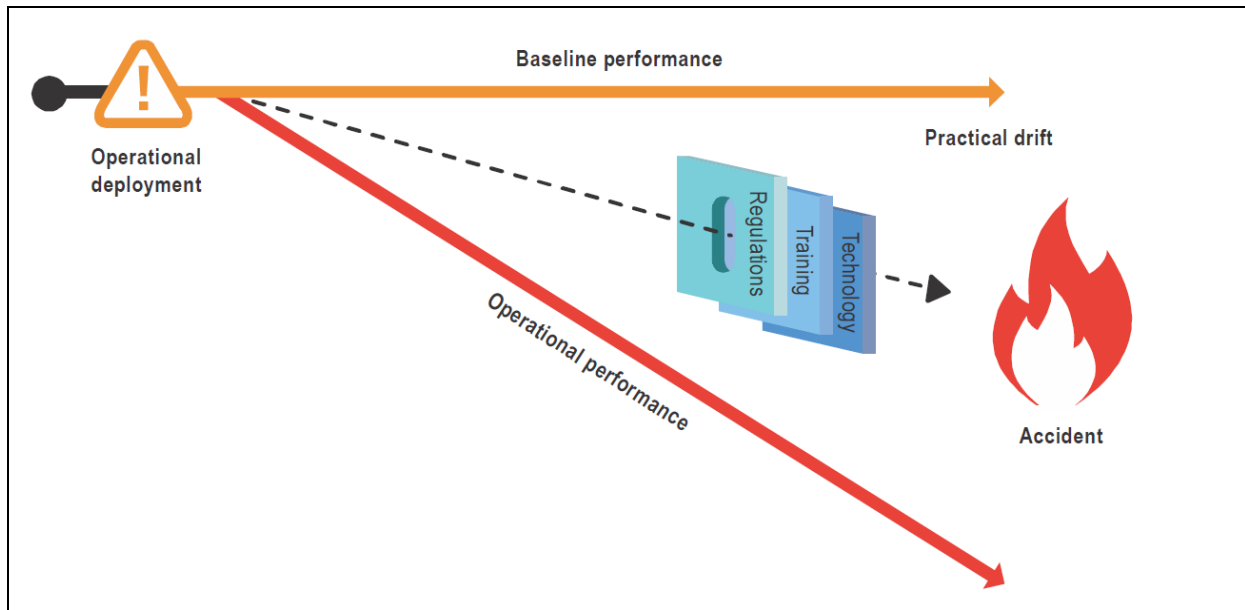
These assumptions represent the baseline (or ideal system performance), which is graphically presented as a straight line from the beginning of operational deployment as shown in Figure 3.

As per (ICAO, 2018) (Snook, 2000), once operationally deployed, the system should ideally perform as designed, following baseline performance (orange line) most of the time. In reality, the operational performance often differs from the assumed baseline performance as a consequence of real-life operations in a complex, ever-changing and usually demanding environment (red line). Since the drift is a consequence of daily practice, it is referred to as a „practical drift”.

The term „drift” is used in this context as the gradual departure from an intended course due to external influences (ICAO, 2018). Some of the reasons for the practical drift include:

- technology that does not operate as predicted,
- procedures that cannot be executed as planned under certain operational conditions,
- changes to the system, including the additional components,
- interactions with other systems,
- safety culture,
- adequacy (or inadequacy) of resources (e.g., support equipment),
- learning from successes and failures to improve operations, and so forth.

Safety assurance activities include audits, observations, and monitoring of SPIs and can help reveal activities that are „practically drifting”. Analysing the safety information to find out why the drift is happening helps to mitigate the safety risks. The closer to the beginning of the operational deployment that practical drift is identified, the easier it is for the organisation to intervene.



**Figure 3 Concept of practical drift**

*Source: (ICAO, 2018)*

Over the years many different accident causation models have been designed. Some of them include: models of accident causation and their application (Lehto & Salvendy, 1991), Occupational Accident Models (Attwood, et al., 2006), Bayesian networks and influence diagrams as a guide to construction and analysis (Kjaerulff & Madsen, 2008), multi-linear (STEP) and systemic (FRAM) methods for accident analysis (Herrera & Woltje, 2010), accident models and organisational factors in air transport (multi-method models) (Roelen, et al., 2011) (Al-shanini, et al., 2014), SHIPP methodology, i.e. predictive accident modelling (Rathnayaka, et al., 2011), use of Functional Resonance Analysis Method (FRAM) in a mid-air collision to understand some characteristics of the air traffic management system resilience (de Carvalho, 2011), Bayesian inference for probabilistic models (Pearl, 2009) (Kelly & Smith, 2011), Object-Oriented Bayesian Networks (OOBN) for aviation accident modelling and technology portfolio impact assessment (Shih, et al., 2012), systems-based accident analysis methods with a comparison of Accimap, HFACS, and STAMP (Svedung & Rasmussen, 2002) (Salmon, et al., 2012) (Yousefi, et al., 2018) (Valdez Banda & Goerlandt, 2018) (Patriarca, et al., 2020) (Ozan Ceylan, et al., 2022) (Zhang, et al., 2022), accident analysis models based on Bayesian network and evidential reasoning approach (Wang, et al., 2013), application of Bayesian networks to quantitative assessment of safety barrier performance in the prevention of major accidents (Kurowicka & Cooke, 2006) (Ale, et al., 2009) (Koller & Friedman, 2009) (Hänninen & Kujala, 2010) (Hänninen & Kujala, 2012) (Villa & Cozzani, 2016), Accident Causation Analysis and Taxonomy (ACAT) model of complex industrial system from both system safety and control theory perspectives (Li, et al., 2017), a Monte Carlo evolution of the Functional Resonance Analysis Method (FRAM) to assess performance variability in complex systems (Patriarca, et al., 2017), 24Model, i.e., a modern accident causation model (Gui, et al., 2019), and examples of systems thinking accident analysis models for sustainable safety management (Delikhoon, et al., 2022).

## **2.3 Safety management system as an operational tool to prevent accidents or incidents**

### 2.3.1 Definition of aviation safety management system

A Safety Management System (SMS) is a formal organisational system to manage safety. It integrates active safety management tools, including senior management commitment, hazard identification, risk management, risk mitigation, safety reporting, audit, investigations and remedial actions, safety culture and education supported by clear policies and processes (ICAO, 2018) (BCAA, 2010) (Wang, et al., 2017) (Hollnagel, 2014).

The traditional approach focused on aligning with increasingly complex regulatory requirements, which functioned well until the late 1970s, when the trend came to a stagnation point in the number of accidents and incidents. Accidents continued to happen despite constantly improved rules and regulations. This approach to safety was reactive, acting after events through regulations that are aimed at preventing its recurrence (BHDCA, 2014) (Stolzer & Goglia, 2015) (Steiner, 1998).

The modern approach is shifting from a reactive to a proactive approach. In addition to existing rules and regulations, it is necessary to develop a number of other activities that improve flight safety: application of risk assessment methods, commitment of administrative bodies in flight safety management, the development of an organisational culture that encourages safety practices and communication and actively manages flight safety, effective implementation of standard operating procedures, including use of checklists and briefings, a „just culture” environment that encourages effective reporting of hazards and incidents, organisation of a system for the collection, analysis and exchange of significant safety data resulting from normal operations, investigation of accidents and serious incidents identifying systemic shortcomings (rather than searching for the culprit), integration of flight safety training (including human factor) for operational staff, exchange of acquired knowledge and best practices through active exchange of safety information (between organisations and states), and systematic safety monitoring and performance monitoring to evaluate system condition to reduce or eliminate problem areas.

In the modern system, the greatest attention is paid to building a positive organisational culture, which often must overcome the negative aspects of existing national and professional cultures (BHDCA, 2014).

The strategy that each organisation adopts for its SMS will reflect the corporate safety culture and it can vary from purely reactive, responding only to the occurrence of accidents, to strategies that are highly proactive in their search for safety issues. Traditional or reactive, the process is characterized by subsequent repairs. In a modern or proactive approach, preventive reform plays a major role.

According to (Adjekum, 2014), Safety Management System (SMS) is also an organized approach to a systemic safety improvement. The perspective of the safety management as an

organisational process and as a core business function clearly places ultimate safety accountability and responsibility at the highest level of any aviation organisation.

It is important to recognise that SMS is a top-down driven system, which means that the accountable manager of the any organisation is responsible for the implementation and continuing compliance with the SMS. Without the full support of the accountable manager, SMS will not be effective. There is no 'one size fits all' model of SMS that will cater to all types and size of service providers. Complex SMS systems are likely to be inappropriate for small organisations. Therefore, such organisations should tailor their SMS to suit their size, nature and complexity of their activities and allocate resources accordingly (ICAO, 2018) (CCAA, 2021).

Safety management systems are commonly used in the aviation domain to systematically manage risks to aviation safety. ICAO-based SMS principles (ICAO, 2018) (AG-DASA, 2015) allow for the following: SMS to be tailored to the scope of equipment/aircraft, operations and maintenance to be conducted by the unit; a phased SMS introduction based on complementary organisational culture change management programs and timelines; and agreement of individual SMS plans' scope by the aviation regulator.

However, as Civil Aviation Authority of New Zealand and Burin indicate (CAA NZ, 2013) (Burin, 2013), by using today's data collection and analysis capabilities, prediction may enable to look deeper into the already identified high-risk areas to gain more insight into how effective risk-reduction efforts are and perhaps identify risk-reduction gaps that are missed.

### 2.3.2 Aim and purpose of establishing an aviation safety management system

Safety management systems have made a large contributions to aviation safety since the first introduction in the field. Today every aviation organisation has the obligation to implement safety management system (SMS) and actively record and report every occurrence (hazard) that happens or potentially could happen in the organisation (Canders, 2016). To ensure that continuous safety improvement and harmonized global air navigation modernization advance hand-in-hand, global, regional, and national aviation safety planning is essential (Yeun, et al., 2014) (Ellis, et al., 2021).

ICAO's Global Plans define the means and targets by which ICAO, States and aviation stakeholders can anticipate and efficiently manage air traffic growth while proactively maintaining or increasing safety. The policies, procedures and systems that allow civil aviation to realize such goals while remaining safe, secure, efficient, and environmentally sustainable, are prescribed within ICAO's coordinated international Standards and Recommended Practices (SARPs). All of these activities are harmonized by the principles and objectives outlined in ICAO's Global Aviation Safety Plan (GASP) as well as the Annex 19 on Safety Management (ICAO, 2013) (ICAO, 2016).

According to (ICAO, 2018) (Wood, 2003), there are many benefits to implementing safety management in general, and some include: strengthened safety culture, documented, process-based approach to assure safety, better understanding of safety-related interfaces and

relationships, enhanced early detection of safety hazards, safety data-driven decision-making, enhanced communication of safety, evidence that safety is a priority, improved efficiencies, possible financial savings, and cost avoidance.

### 2.3.3 Regulatory and operational requirements of the aviation safety management system

All rules in aviation are normatively covered by a series of international conventions relating to the safety of air navigation and the conditions of air traffic operations.

The efforts of the international community, during the development of aviation, were aimed at unifying the rules by legal regulation of global regulatory documents, so today aviation is the best legally regulated transport industry in the world.

The dynamics of adopting basic international conventions, their partial amendments to relevant protocols, and the dynamics of adopting technical standards through annexes, was in the function of aviation development, especially in technical terms, and in support of solving current international problems (McIntyre, 2002).

Globally, the most important organisation in the field of air transport is the International Civil Aviation Organisation (ICAO), which brings together most of the world (currently 193 member states).

The International Civil Aviation Organisation (ICAO) is a governmental organisation under the United Nations (UN), founded in Chicago in 1944, and the structure and scope of its work is defined by the founding Convention on International Civil Aviation.

On the global level, International Civil Aviation Organisation (ICAO) prescribes 19 Annexes of Standard and Recommended Practices (SARPs) among which Annex 19 (ICAO, 2016) brings rules and regulations regarding Safety Management and issues ICAO Safety Management Manual (ICAO, 2018) as a guide for each member state to implement State Safety Programmes on the national level and Safety Management Systems within each aviation organisation.

ICAO Annex 19 – Safety Management (ICAO, 2016) brings together material from existing Annexes on national safety programmes and safety management systems (SMS), as well as other elements, including the collection and use of safety data and state safety oversight activities. The purpose of consolidating all these materials into a single Annex is to draw Member States' attention to the importance of integrating their own safety management activities. It also facilitates the further development of safety management provisions.

The Standards and Recommended Practices (SARPs) in this Annex are intended to assist Member States in managing aviation safety risks. Given the growing complexity of the global air transport system and its interconnected aviation activities, it is necessary to ensure the safe operation of aircraft. This Annex supports the continued evolution of a proactive strategy to improve safety. The foundation of a proactive safety strategy is based on the implementation of the State Safety Programme (SSP), which systematically addresses safety risks.

In 2006, the International Civil Aviation Organisation (ICAO) issued an ICAO Doc 9859 – Safety Management Manual (SMM). This manual was created as a result of the accelerated technological development of aviation, as well as its rapid growth and the need to control the risk that arises as a result. It is the basis for the safety management of all participants in the air transport process, including those related to flight crew. According to this manual, all safety systems in international norms are developed and it lists all the basic elements that should be implemented as well as the principles and ideas that should be followed.

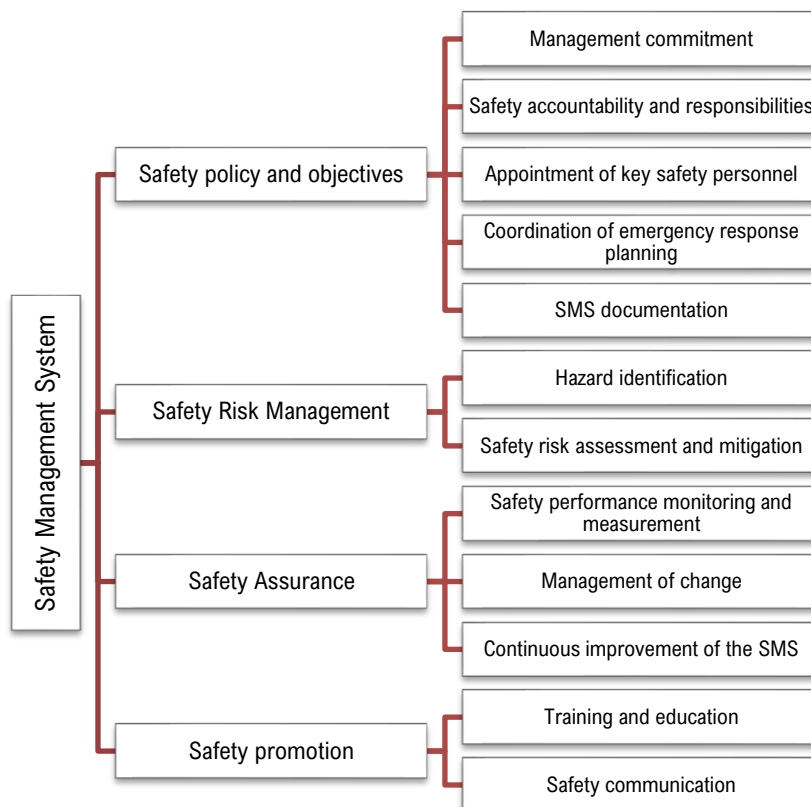
On the territory of European Union (EU) the duty of rulemaking is delegated to European Union Aviation Safety Agency (EASA). EASA issues regulations regarding safety reporting and accident investigation as well as general regulations on implementing safety management systems in the organisations within the territory of EU.

The Commission Regulation (EU) 376/2014 (EASA, 2014) and Implementing Regulation (EU) 2015/1018 (EASA, 2015) establish regulations regarding safety reporting and reportable occurrences, while Commission Regulation (EU) 965/2012: Part-ORO (EASA, 2012), Commission Regulation (EU) 1178/2011: Part-ORA (EASA, 2011), Commission Regulation (EU) 1321/2014 (EASA, 2014) and Commission Regulation (EU) 139/2014: Part-ADR.OR (EASA, 2014), and other, establish regulations on implementing and maintaining effective SMS for every operator or organisation providing services in the field of aviation in EU.

#### 2.3.4 Basic ICAO framework: components and elements of the aviation safety management system

Safety Management Systems (SMS) is the mechanism being used to improve an industry with an already exceptional aviation safety record. ICAO defines SMS as an organized approach to managing safety, to include the necessary organisational structures, accountabilities, policies, and procedures. The four main components (pillars) of SMS are: safety policy and objectives, risk management, safety assurance, and safety promotion. According to (ICAO, 2018) (CCAA, 2021) (Cusick, et al., 2017) (Ferguson & Nelson, 2014) (CG, 2015) (Velazquez & Bier, 2015) the framework of organisational SMS should include previously mentioned 4 components and accompanying 12 elements: 1. safety policy and objectives: 1.1 management commitment, 1.2 safety accountability and responsibilities, 1.3 appointment of key safety personnel, 1.4 coordination of emergency response planning, 1.5 SMS documentation; 2. safety risk management: 2.1 hazard identification, 2.2 safety risk assessment and mitigation; 3. safety assurance: 3.1 safety performance monitoring and measurement, 3.2 management of change, 3.3 continuous improvement of the SMS; 4. safety promotion: 4.1 training and education, 4.2 safety communication. Managing and controlling errors, hazards, and risks are all part of the safety system defined as SMS. SMS framework is shown in the Figure 4.





**Figure 4 ICAO framework of the SMS**  
 Source: Author according to (ICAO, 2016) (ICAO, 2018)

### 2.3.5 Implementation of the aviation safety management system

The formal establishment of SMS is clearly defined in ICAO standards. ICAO Annexes require the implementation of SMS by air traffic control service providers (ICAO Annex 11), certified airports (ICAO Annex 14), aircraft and helicopter operators (ICAO Annex 6, Parts I, II and III), certified training organisations (ICAO Annex 1), and certified maintenance organisations (ICAO Annex 6, Part I) (Georgiev, 2021) (Chatzi, 2019).

SMS is a management system that must be fully integrated into the day-to-day operations of a particular organisation. It follows that SMS is not approved by the regulator, i.e., Competent Aviation Authority (CAA) as a stand-alone process but is assessed through the organisation's certification and oversight process (e.g., through the Air Operator Certificate (AOC) issuance process, EASA Part 145, airport certification, etc.). The service provider will be deemed to have met the initial requirements after CAA receives evidence which proves that the competencies and responsibilities of management are clearly defined, the safety policy is documented and signed by the responsible manager, SMS gap analysis is performed, and results are documented. The service provider must conduct a Gap Analysis (GAP) in order to identify safety elements or procedures that already exist within the organisation, in order to be able to

determine additional elements or procedures necessary for the implementation and maintenance of SMS.

A documented implementation plan defining specific actions and appropriate timelines begins. The implementation plan is a realistic strategy for the implementation of SMS defined in accordance with the needs and capabilities of the organisation, and which also defines the approach applied to safety management. It is developed by a group that:

- has the appropriate experience to create a plan,
- meets regularly with senior management,
- has sufficient resources (including time for meetings),
- implements a strategy for the implementation of SMS that will meet the needs of the organisation in terms of safety,
- defines the approach that the organisation will adopt for safety management.

The SMS implementation plan must include the following elements:

- safety policy and objectives,
- system description,
- GAP analysis,
- SMS components,
- roles and responsibilities in the safety system,
- safety reporting policy,
- ways of employee participation,
- measurement of safety performance,
- communication on safety issues,
- safety training, and
- management assessment of safety performance.

Guidance for service providers to establish an SMS implementation plan is defined in the ICAO SMM Doc 9859. The SMS implementation plan is developed in agreement with the Accountable Manager (AM) of the organisation and the responsible managers of the organisation's departments. Upon completion of the plan, the AM of the organisation adopts and implements the plan. The SMS implementation plan includes timelines and implementation of procedures that are in line with the requirements identified in the GAP analysis process, the size of the service provider and the complexity of the products or services provided by the organisation.

System overview and description of SMS elements and their interface with existing systems and processes is the first step in defining the scope and applicability of SMS. Such an overview (GAP Analysis) provides the ability to identify deficiencies related to SMS components and elements of service provider (Ostrowski, et al., 2014).

The implementation of SMS by service providers requires an analysis of their system to determine the components and elements of SMS that already exist in the organisation, and which components and elements need to be added or modified to meet implementation requirements. This analysis, known as GAP analysis, involves comparing SMS requests with existing service provider resources. After implementation and documentation, the GAP analysis

is the basis for defining the SMS implementation plan. A template for conducting the GAP analysis is contained in ICAO SMM Doc 9859. Each question is designed to answer „Yes“ or „No“. The answer „Yes“ indicates that the service provider already has implemented components or elements of the ICAO SMS framework in its system, and that they either meet or exceed the set requirements. The answer „No“ indicates that there are differences between the components or elements of the ICAO SMS framework and the service provider's system.

The obtained results of GAP analysis are the first step in the implementation of SMS, and they are used to determine the operator's policy, objectives and procedures. By systematically conducting the analysis on an annual or quarterly basis, it is checked whether the SMS works effectively and whether it is in accordance with the required regulations.

SMS implementation is a systematic process. Such a systematic process can be divided into four phases of SMS implementation (i.e., phased approach). This process can be quite a demanding task, so a phased approach is usually applied. The process depends on various factors, such as availability of instructions (guidelines) and/or resources required for implementation, as well as prior knowledge of the SMS of a particular service provider.

The initial implementation phase usually includes implementation of elements 1.1, 1.2, 1.3, 1.4, 1.5, and 4.2 of the ICAO SMS framework. Initial phase should be completed within the time period of 12 months. The initial implementation phase requires that the applicant (service provider) submits to the CAA the following:

- name and surname of the accountable manager,
- name and surname of the person responsible for the implementation of the SMS,
- written safety policy, which includes a statement of commitment to the implementation of the SMS (signed by the accountable manager),
- documentation on the GAP analysis between the existing organisational system and the required SMS framework,
- organisational plan for the implementation of SMS, defined on the basis of the SMS framework and internal GAP analysis of service provider.

The second implementation phase usually includes implementation of elements 1.5, 2.1, 2.2, 4.1, and 4.2 of the ICAO SMS framework. Second phase should be completed within the time period of 12 months. The service provider must prove that its system includes the following:

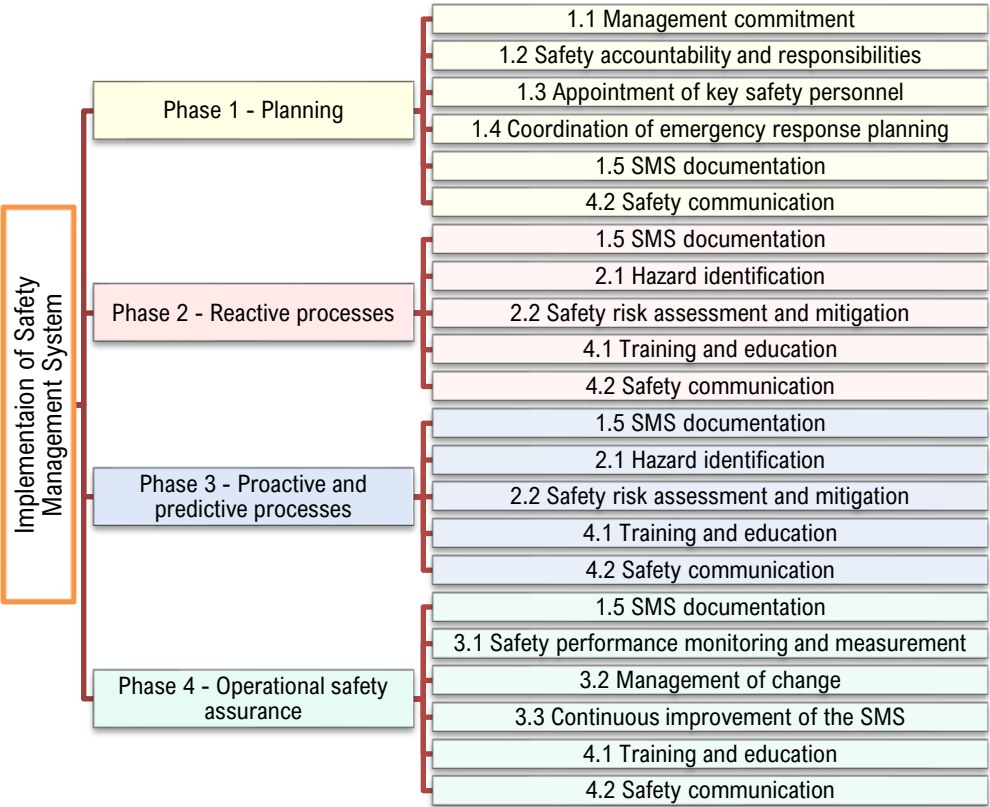
- documented procedures related to the required SMS components,
- a process for reactive risk management such as hazard investigation, hazard analysis and identification, and risk management,
- associated support elements such as training, methods of collecting, storing and distributing data and communication on safety within the organisation, as well as communication with other organisations.

The third implementation phase usually includes implementation of elements 1.5, 2.1, 2.2, 4.1, and 4.2 of the ICAO SMS framework. Third phase should be completed within the time period of 18 months. The service provider must demonstrate that, in addition to the components for which it has demonstrated during second phase, its system includes a process for proactive

hazard identification and associated methods of data collection, storage and distribution, as well as a management process risks. Required components include:

- documented procedures related to the required SMS components,
- a process for a reactive safety reporting system,
- training on the reactive safety reporting system process,
- process for proactive hazard identification,
- the choice of safety performance indicators and targets, and definition of an acceptable level(s) of safety.

In the final (fourth) implementation phase, the service provider must demonstrate that, in addition to the components for which it has already demonstrated compliance during second and third phase, its system must include: training, just culture, quality assurance, and continuous improvement of SMS. Final phase should be completed within the time period of 18 months. The fourth implementation phase usually includes implementation of elements 1.5, 3.1, 3.2, 3.3, 4.1, and 4.2 of the ICAO SMS framework. Figure 5 shows phased approach of implementing safety management system.



**Figure 5 Phased approach of SMS implementation**  
*Source: Author according to (ICAO, 2016)*

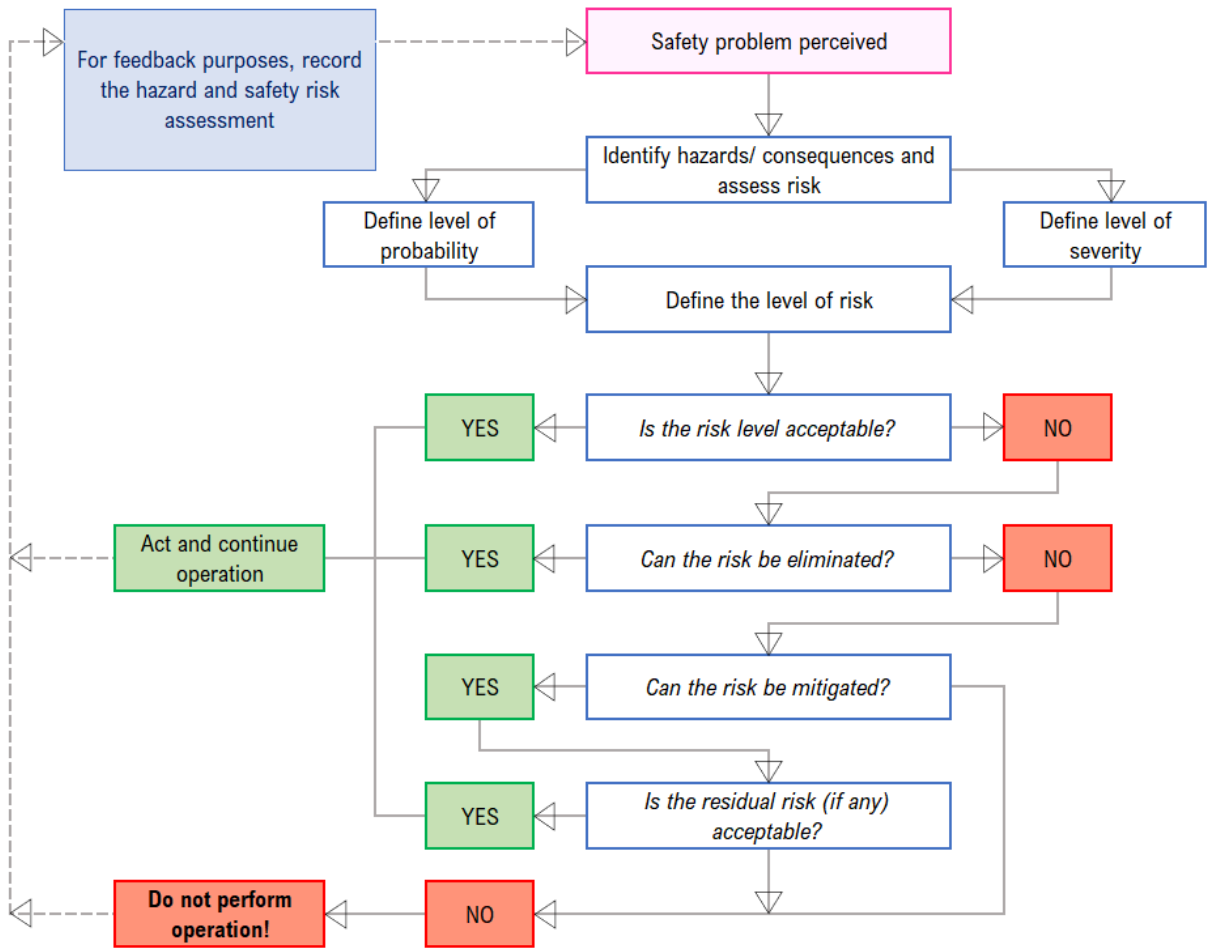
### 2.3.6 Safety risk management and safety assurance – the core components of an effective aviation safety management system

Implementing and maintaining effective SMS requires each aviation organisation to comply with all regulations mentioned above. Effective SMS has to have four main components in place in order to work properly and efficiently. Those four components, as previously mentioned, include safety policy, safety risk management, safety assurance and safety promotion. The second component is Safety Risk Management (SRM), and it is the core of efficient SMS. It deals with occurrence (hazard) identification, risk assessment and risk mitigation (Čokorilo & Dell'Acqua, 2013) (Čokorilo, et al., 2011) (Jakovljević, et al., 2017) (Steiner, 1998) (Bartulović, 2012). The third component is Safety Assurance, and it includes safety performance monitoring and measurement, management of change and continuous improvement of SMS.

Implementation of the safety management system includes safety risk management and adoption of measures and procedures to reduce (mitigate) and eliminate unacceptable risks, incident and accident reporting system, safety oversight in work processes, safety training, safety management system documentation and plan for implementation and continuous improvement of the safety management system.

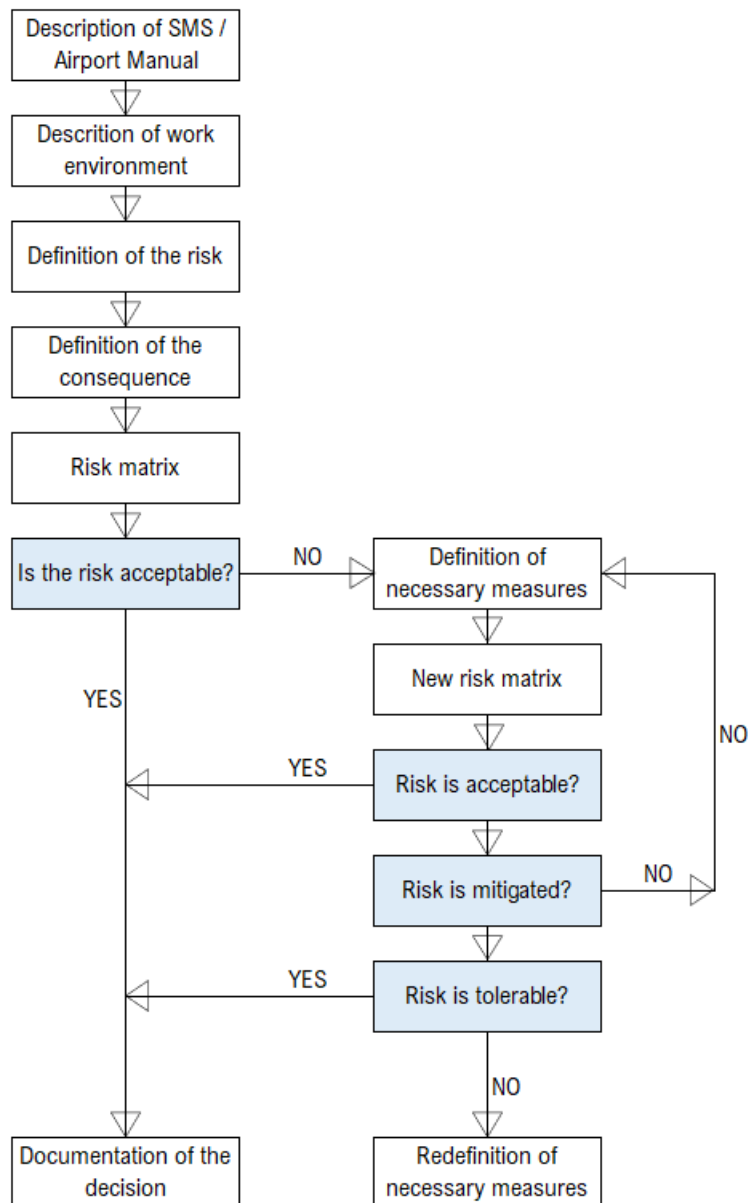
#### *2.3.6.1 Safety Risk Management*

Safety is a state in which the risk of harm to persons or property is reduced and maintained at an acceptable level, through a continuous process of hazard identification and safety risk management. The process that leads from hazard identification to risk assessment and risk mitigation is a risk management process (Rezaei & Borjalilu, 2018) (Müller, et al., 2014) (Uyar, 2019). A diagram of the safety risk management process is shown in Figure 6.



**Figure 6 Safety risk management process**  
 Source: Author according to (ICAO, 2018)

Figure 7 shows an example of safety risk management process at an airport.



**Figure 7 Example of the safety risk management process at an airport**

*Source: Author*

### 2.3.6.1.1 Hazard identification

Hazard is defined a condition or object that can cause injuries to personnel, damage to equipment or structures, loss of materials, or loss of ability to perform a prescribed function. Consequence is defined as the potential outcome(s) of the hazard (Mosleh, et al., 2004). In order to identify hazards, the following should be considered:

- design factors, including equipment and design tasks,
- procedures and operational practices, including documentation and checklists,
- communication, including means, terminology, and language,

- organisational factors, such as employment policies, training, reward systems, and resource allocation policies,
- environmental factors, such as environmental noise and vibration, temperature, lighting and protective equipment and clothing,
- regulatory factors, including the applicability and enforceability of regulations; certification of equipment, personnel, and procedures; and adequacy of supervision,
- defence mechanisms, including detection and warning systems, and fail-safe equipment,
- human performance, including medical conditions and physical limitations.

Sources of hazard identification are the following:

- internal sources,
- flight data analysis,
- voluntary reporting system,
- audits and surveys,
- external sources,
- accident reports,
- mandatory reporting system.

Safety management methodologies include:

- Reactive safety management methodology,
- Proactive safety management methodology,
- Predictive safety management methodology.

It is the responsibility of the provider to develop, establish and maintain a formal process for the effective collection, recording, processing and provision of feedback on hazards in operations, collected on the basis of reactive, proactive and predictive methods of collecting safety data (Zikrullah, et al., 2021).

Reactive methods include mandatory incident and accident reporting information. Proactive methods include voluntary reporting of safety incidents, confidential reporting system, safety analysis (investigation), operational safety audit and safety assessment. Predictive methods of collecting safety data are based on direct observations of operational personnel during normal operations.

#### *2.3.6.1.2 Safety risk assessment and mitigation*

Risk is the possibility of negative consequences of hazard, expressed in terms of severity and probability (Araujo Vieir, et al., 2017) (Vileiniskis & Remenyte-Prescott, 2017) (Netjasov & Janic, 2008) (Insua, et al., 2018) (Luxhøj, et al., 2003) (Bedford & Cooke, 2001) (Biernbaum & Hagemann, 2012). The obligation of the provider is to develop, establish and maintain a formal risk management process that ensures analysis (in terms of probability and severity of events), assessment (in terms of acceptability/ tolerability) and control (in terms of mitigation) of risks



at an acceptable level. It must also define those levels of management that have the authority to make decisions on the acceptability of safety risks (CCAA, 2021).

The risk assessment considers the probability and severity of any adverse consequences that may result from the identified hazard (Rasmussen, 1997) (Patankar & Taylor, 2004) (Salmon, et al., 2010) (Albery, et al., 2016).

The probability of an accident or incident (hazard) is directly dependent on:

- technical and technological adaptations of means of work,
- technical correctness of means of work,
- technical correctness of airport infrastructure,
- quality of defined standard operating procedures,
- quality of training and experience of employees, and
- work culture.

In addition to these factors, during the analysis of the probability of a hazard, it is very important to determine the quality of the training programme and the experience of employees, and:

- History of risk, i.e., whether a similar accident or incident (hazard) has already occurred, and if so, how many times and in what period?
- Does only one type of device and/or means and/or vehicle have characteristics that contribute to the increase of (analysed) risk?
- How often are devices and/or means and/or vehicles with characteristics that contribute to the increase of (analysed) risk used?
- How many employees act during the work in a way that contributes to the increase of (analysed) risk?

Table 1 shows safety risk probability. As a result of the analysis of the probability of a hazard, each risk is assessed by one of the following probability categories:

- Extremely improbable (1), or
- Improbable (2), or
- Remote (3), or
- Occasional (4), or
- Frequent (5).

**Table 1 Safety risk probability table**

<b>Probability</b>	<b>Meaning</b>	<b>Value</b>
Frequent	Likely to occur many times (has occurred frequently)	5
Occasional	Likely to occur sometimes (has occurred infrequently)	4
Remote	Unlikely to occur, but possible (has occurred rarely)	3
Improbable	Very unlikely to occur (not known to have occurred)	2
Extremely improbable	Almost inconceivable that the event will occur	1

Source: Author according to (ICAO, 2018)

Risk severity analysis, if an accident or an incident occurs, involves answering the following questions:

- Are and how many people are directly endangered (passengers, staff, visitors)?
- What are the probable financial losses (costs for repair of damaged equipment, facilities and other assets, direct costs of operators, collateral damage of others – business partners, impact on future business)?
- Whether and what impact it may have on the immediate environment (spilled fuel and/or lubricant and/or other dangerous goods)?
- What are the possible political and economic implications given the reaction of the media and the interest of public opinion?

Table 2 shows safety risk severity. As a result of the hazard severity analysis, each risk is assessed with one of the following severity categories:

- Catastrophic (A), or
- Hazardous (B), or
- Major (C), or
- Minor (D), or
- Negligible (E).

**Table 2 Safety risk severity table**

Severity	Meaning	Value
Catastrophic	Aircraft / equipment destroyed Multiple deaths	A
Hazardous	A large reduction in safety margins, physical distress, or a workload such that operational personnel cannot be relied upon to perform their tasks accurately or completely Serious injury Major equipment damage	B
Major	A significant reduction in safety margins, a reduction in the ability of operational personnel to cope with adverse operating conditions as a result of an increase in workload or as a result of conditions impairing their efficiency Serious incident Injury to persons Nuisance	C
Minor	Operating limitations Use of emergency procedures Minor incident	D
Negligible	Few consequences	E

*Source: Author according to (ICAO, 2018)*

The risk matrix is a useful risk assessment tool. While the severity of the consequences of an event can be easily identified, the assessment of the probability of an event is subject to subjectivity.

According to the product of the expressed values (probability of a hazard occurring x estimated severity if a hazard occurs) each risk is categorized as:

- Acceptable, or
- Tolerable, or
- Intolerable.

Based on the performed risk categorization:

- a matrix of all risks of work processes, and maintenance of devices and means is made,
- measures and procedures are defined, and the employees responsible for their implementation, in order to reduce intolerable and tolerable risks to the level of acceptable, and
- implementation and qualitative impact of all defined measures and procedures, is constantly monitored, in order to redefine them in cases where the performance is not satisfactory.

Table 3 shows the safety risk assessment matrix.

**Table 3 Safety risk assessment matrix**

Safety Risk		Severity				
Probability		Catastrophic A	Hazardous B	Major C	Minor D	Negligible E
Frequent	5	5A	5B	5C	5D	5E
Occasional	4	4A	4B	4C	4D	4E
Remote	3	3A	3B	3C	3D	3E
Improbable	2	2A	2B	2C	2D	2E
Extremely improbable	1	1A	1B	1C	1D	1E

*Source: Author according to (ICAO, 2018)*

The matrix shown in Table 3 presents the methodology for determining the safety risk index. The columns of the matrix represent the probability of the occurrence of the event, and the rows of the matrix represent the severity of the damage caused in the case of the occurrence of the event. According to (ICAO, 2018), safety risk index rating is created by combining the results of the probability and severity scores. The respective severity/probability combinations are presented in the safety risk assessment matrix in Table 3. The safety risk assessment matrix is used to determine safety risk tolerability. For example, a situation where the safety risk probability has been assessed as Occasional (4), and the safety risk severity has been assessed as Hazardous (B), it will result in a safety risk index of (4B).

The matrix fields are marked with three colours. Red fields represent an intolerable (unacceptable) area or intolerable (unacceptable) under existing conditions. Yellow fields represent an area that is tolerable or acceptable based on risk assessment and mitigation (if deemed necessary, it may require a management decision). Green fields are an acceptable area.

The outcome of the risk classification, i.e., risk index is used to determine the mitigation measures (Table 4 below). Table 4 shows safety risk tolerability and shows that there are three main levels of risk tolerability.

**Table 4 Safety risk tolerability**

Safety Risk Index Range	Safety Risk Description	Recommended Action
5A, 5B, 5C, 4A, 4B, 3A	<b>INTOLERABLE</b>	Take immediate action to mitigate the risk or stop the activity. Perform priority safety risk mitigation to ensure additional or enhanced preventative controls are in place to bring down the safety risk index to tolerable.
5D, 5E, 4C, 4D, 4E, 3B, 3C, 3D, 2A, 2B, 2C, 1A	<b>TOLERABLE</b>	Can be tolerated based on the safety risk mitigation. It may require management decision to accept the risk.
3E, 2D, 2E, 1B, 1C, 1D, 1E	<b>ACCEPTABLE</b>	Acceptable as is. No further safety risk mitigation required.

Source: Author according to (ICAO, 2018)

Risks need to be managed to keep them as acceptable as possible. Risks should be managed in a way that balances the time, cost, and difficulty of implementing measures to reduce or eliminate risks. The level of risk can be reduced by reducing the severity of the event or by reducing the exposure to the event. Corrective action must consider any elements of the existing defences, as well as the inability of those defences to maintain an acceptable level of safety. Corrective measures should be subject to further risk assessment procedure, in order to be able to determine whether the observed risk is at an acceptable level and whether no additional risks would emerge in the operations.

**2.3.6.2 Safety Assurance**

Safety consists of the processes and activities undertaken by the service provider to determine whether the SMS works according to expectations and requirements. The service provider continuously monitors its internal processes as well as its operational environment to detect changes or deviations that may pose new safety risks or degrade existing risk controls. Such changes or deviations can then be addressed along with the safety risk management process.

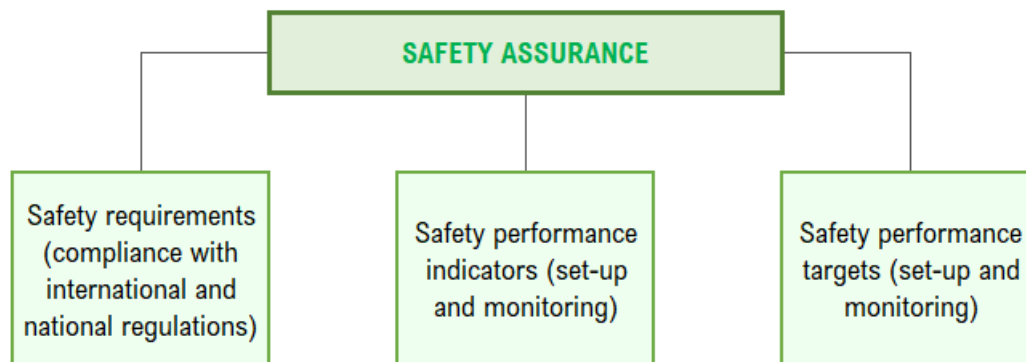
The Safety Assurance (SA) process complements the quality assurance system, with each having requirements for analysis, documentation, audit and management evaluation to ensure that certain performance criteria are met.

While quality assurance typically focuses on an organisation’s compliance with regulatory requirements, safety assurance specifically monitors the effectiveness of safety risk controls.

The organisation must develop and maintain:

- means to verify the safety performance of the organisation, and
- means to verify the effectiveness of safety risk controls.

Figure 8 shows elements of Safety Assurance component, i.e., third vital component of the safety management system.



**Figure 8 Safety assurance**

*Source: Author according to (ICAO, 2018)*

#### 2.3.6.2.1 Safety performance monitoring and measurement

The service provider is obliged to develop and maintain means to check the safety performance of the organisation and confirm the effectiveness of safety risk controls.

The internal audit, i.e., audit process is one of the ways to monitor compliance with safety regulations, the foundations on which the SMS is built, and to assess the effectiveness of safety risk controls and SMS.

The safety performance of the service provider must be checked against the safety performance indicators and safety performance targets of the SMS in order to achieve the safety objectives of the organisation.

The safety performance of the organisation is determined and verified by the following tools:

- Reporting systems,
- Safety studies,
- Safety inspections,
- Safety audits,
- Safety surveys,
- Internal safety investigations, etc.

Safety audits are used to ensure that the structure of the SMS is correct in terms of:

- Employees,
- Compliance with approved procedures and instructions.
- Levels of competence and competence for:
  - Equipment and facility handling,
  - Maintaining performance levels.

Safety surveys examine certain elements or processes of a particular operation such as:

- Problem areas in everyday work,
- Perceptions and opinions of operational staff,
- Areas of disagreement or confusion.

Safety surveys may include the use of:

- Checklists,
- Questionnaires,
- Unofficial confidential interviews.

As survey data is subjective, verification may be required before corrective action. Surveys can provide a cheap source of significant safety information.

Internal safety investigations include those that do not need to be reported to state authorities, such as:

- Turbulence in flight (flight operations),
- Frequency congestion (ATC),
- Defects in material (maintenance),
- Ramp vehicles operations (airports).

#### *2.3.6.2.2 Management of change*

The service provider is obliged to develop and maintain a process of identifying changes that may affect the level of safety risk associated with aeronautical products or services and to identify and manage safety risks that may arise from such changes. Such process is obliged to:

- describe ways to ensure safety performance before implementing changes,
- eliminate or modify safety risk controls that are no longer necessary or effective due to changes in the operating environment.

Aviation organisations are experiencing permanent changes due to expansion, introduction of new equipment or procedures. Changes can:

- introduce new hazards,
- influence the appropriateness of risk mitigation measures,
- affect risk mitigation effectiveness,
- come from external changes,
- come from changing regulatory requirements,

- influence protection,
- influence reorganisation of air traffic control,
- introduce internal changes,
- introduce changes in management,
- introduce new equipment,
- introduce new procedures.

#### *2.3.6.2.3 Continuous improvement of the safety management system*

The service provider is obliged to monitor and evaluate its SMS processes in order to maintain or continuously improve the overall efficiency of SMS.

Continuous improvement is measured by monitoring the organisation's safety performance indicators that show the degree of well-established and effective SMS (Lu, et al., 2006).

Safety assurance processes encourage SMS improvements through continuous checks and monitoring activities (Ferdous, et al., 2013) (Badreddine & Ben Amor, 2013) (Khakzada, et al., 2013). These goals are achieved through the application of internal assessments and independent SMS audits.

Continuous improvement is achieved through:

- reactive assessment to verify the effectiveness of the risk control and mitigation system, for example through data obtained from investigation of accidents, incidents, and investigation of serious events,
- proactive assessment of facilities, equipment, documentation and procedures through safety studies, inspections, audits, and surveys,
- proactive performance assessment of individuals to verify the fulfilment of their safety responsibilities and competencies.

#### 2.3.7 Overview of the aviation safety management system

Figure 9 shows comprehensive overview of the aviation safety management system with all its elements and processes.

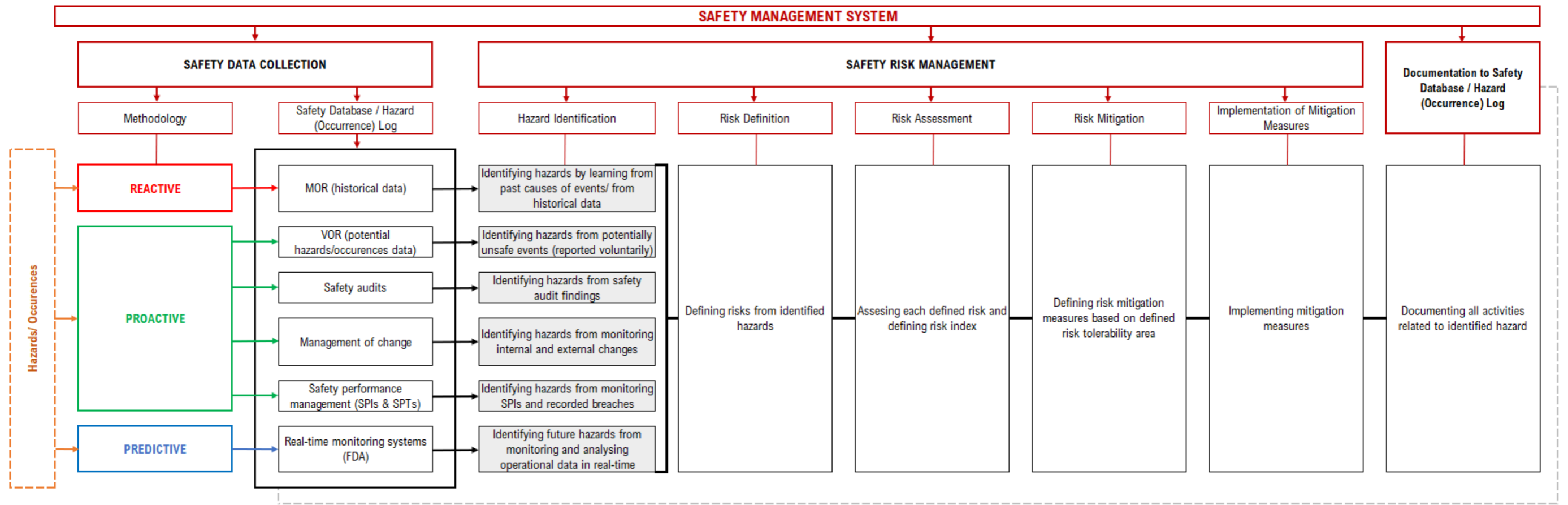


Figure 9 Comprehensive overview of the aviation safety management system  
 Source: Author



### 3 SAFETY PERFORMANCE MANAGEMENT

Safety performance management is central to the functioning of SSPs and SMSs. Properly implemented, it will provide an organisation with the means to determine whether its activities and processes are working effectively to achieve its safety objectives (Chen & Li, 2016) (Patriarca, et al., 2019) (Di Gravio, et al., 2015) (O'Conner, et al., 2011) (Elvik & Elvebakk, 2016). This is achieved through the identification of safety performance indicators (SPIs), which are used to monitor and measure safety performance (Kaspers, et al., 2019) (Sun, et al., 2018). Information obtained through the identification of SPIs ensures senior management to be aware of the current situation and supports decision-making, including determining whether actions are required to further mitigate safety risks to ensure the organisation achieves its safety goals.

General process of safety performance management and the way it is linked with safety data collection and processing systems (SDCPS) and safety analysis (Kaspers, et al., 2016), is shown in Figure 10. The link to safety promotion is shown to highlight the importance of communicating this information throughout the organisation.

Safety performance management helps the organisation to ask and to answer the four most important questions (Onyegiri & Oke, 2017) regarding safety management:

1. What are organisation's top safety risks?
2. What does the organisation want to achieve in terms of safety and what are the top safety risks that need to be addressed?
3. How will the organisation know if it is making progress toward its safety objectives?
4. What safety data and safety information are needed to make informed safety decisions?

The safety performance management process can also be used to establish an acceptable level of safety performance (ALoSP).

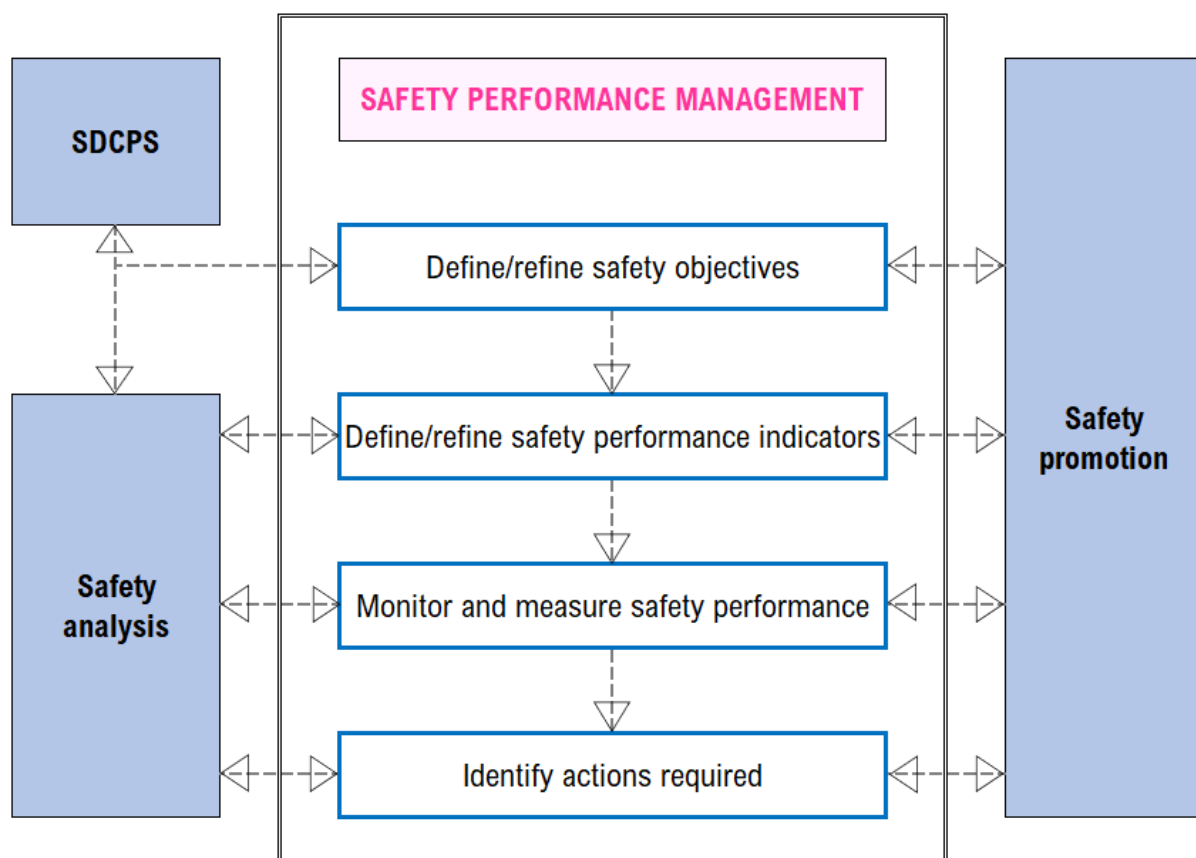
For any service provider, the primary function of safety performance management is to monitor and measure how well it is managing its safety risks. This is achieved through the effective implementation of an SMS that generates information that will be used to make decisions regarding the management of safety, including the implementation of safety risk controls and the allocation of resources.

Safety performance management is an ongoing activity. Safety risks and availability of data change over time. Initial SPIs may be developed using limited resources of safety information. Later, more reporting systems may be established, more safety data may be available and the organisation's safety analysis capabilities will grow stronger. It may be appropriate for organisations to develop simple SPIs initially. As they gather more data and safety management capabilities grow, organisation can consider refining the scope of SPIs and SPTs to better align with the desired safety objectives. Small non-complex organisations may elect to refine their SPIs and SPTs and select generic (but specific) indicators which apply to most aviation systems (Chen, et al., 2019) (Kaspers, et al., 2017). Some examples of generic indicators would be:

- events including structural damage to equipment,
- events indicating circumstances in which an accident nearly occurred,

- events in which operational personnel or members of the aviation community were fatally or seriously injured,
- events in which operational personnel became incapacitated or unable to perform their duties safely,
- rate of voluntary occurrence reports, and
- rate of mandatory occurrence reports.

Larger and more complex organisations may define broader range of SPIs and SPTs. A large airport, for example, providing services to major airlines and situated under complex airspace, might consider combining some of the generic SPIs with deeper-scope SPIs representing specific aspects of their operation. The monitoring of these may require greater effort but will likely produce superior safety results (Sun, et al., 2021).



**Figure 10 Safety performance management process**

*Source: Author according to (ICAO, 2018)*

The set of SPIs and SPTs selected by an organisation should be periodically reviewed to ensure their continued meaningfulness as indications of organisational safety performance. Some reasons to continue, discontinue or change SPIs and SPTs include:

- SPIs continually report the same value (such as 0% or 100%); these SPIs are unlikely to provide meaningful input to senior management decision-making,

- SPIs that have similar behaviour and as such are considered a duplication,
- the SPT for an SPI implemented to measure the introduction of a programme or targeted improvement has been met,
- another safety concern becomes a higher priority to monitor and measure,
- to gain a better understanding of a particular safety concern by narrowing the specifics of an SPI, and
- safety objectives have changed and as a consequence the SPIs require updating to remain relevant (ICAO, 2018).

### **3.1 Safety data collection and processing systems**

The distinction between safety data and safety information is made in the definitions found in Annex 19. Safety data is what is initially reported or recorded as the result of an observation or measurement (Nazeri, et al., 2001) (Rose, et al., 2022) (Shi, et al., 2017) (Kraus, et al., 2018). It is transformed to safety information when it is processed, organized, integrated or analysed in a given context to make it useful for management of safety. Safety information may continue to be processed in different ways to extract different meanings.

Annex 19 requires States to establish safety data collection and processing systems (SDCPS) to capture, store, aggregate, and enable the analysis of safety data and safety information to support their safety performance management activities. SDCPS is a generic term used to refer to processing and reporting systems, databases, and schemes for exchange of safety information and recorded information (Grötschelová, et al., 2021) (Holbrook, 2021) (Robinson, 2019) (Guskova, et al., 2020). The term „safety database” may refer to a single or multiple database(s) (Wilke, et al., 2014).

Service providers are also required to develop and maintain the means to verify their safety performance with reference to their SPIs and SPTs, in support of their safety objectives by means of SDCPS.

Important part of gathering information is report system. Mandatory occurrence reporting systems tend to collect more technical information (e.g., mechanical failures) than human performance aspects. To address the need for a greater range of safety reporting, organisations should also implement a voluntary safety reporting system. It aims to gather more information, such as human factors related aspects, and enhance aviation safety.

Systems for the collection of safety data through self-disclosure reporting systems, including automatic data capture such as aviation safety action programme (ASAP) and FDA programmes (flight operations quality assurance (FOQA) programme, line operations safety audit (LOSA) and the normal operations safety survey (NOSS)), are examples of systems that capture safety data through direct observations of flight crews or air traffic controllers (Sarter & Alexander, 2000).

Many organisations collect a large amount of safety data and safety information, including mandatory and voluntary safety reporting systems as well as automated data capture systems.

This safety data and safety information allows them to identify hazards and supports safety performance management activities.

Each organisation needs to determine what safety data and safety information it must collect to support the safety performance management process and make safety decisions. Safety data and safety information requirements can be determined using a top-down and/or a bottom-up approach. The chosen approach can be influenced by different considerations, such as national and local conditions and priorities, or the need to provide the data to support the monitoring of the SPIs (ICAO, 2018). Table 5 provides examples of typical safety data and safety information.

**Table 5 Sources of safety data and safety information**

<b>Sources</b>	<b>Safety data collecting mechanisms</b>
Data systems	Flight data analysis (FDA) Flight recorders ATC radar
Persons	Occurrence reports Voluntary reports
Civil aviation authority	Mandatory occurrence reports Voluntary reports Risk assessments Risk profiles Industry SPIs/trend analysis Service provider surveillance External and internal audits Enforcement records Incident/accident reports Certification records Aircrew in-flight medical incapacity reports Trends in medical assessment findings
States	Accident/incident database State audits National aviation reviews State safety programme SPIs and SPTs ICAO USOAP OLF In-flight medical incapacity database Other state partner
Accident investigation authority	Accident/incident Notifications/reports Safety investigation and analysis
RSOO/RAIOs	Regional safety programmes Regional accident investigations
ICAO	USOAP activities State safety briefings Regional safety briefings
Other States	Significant safety concerns
Approved training organisations	Mandatory occurrence reports Voluntary reports Risk assessment register SPIs trend analysis Training data Quality assurance reports
Air operators	Mandatory occurrence reports

	Voluntary reports Flight data analysis (FDA) Fatigue risk management system Recorded data (flight data recorder (FDR), cockpit voice recorder (CVR), video, ambient, streamed data) Risk assessment register SPIs/trend analysis Maintenance records Internal audits Reliability programme reports Training records
Approved Maintenance Organisations	Mandatory occurrence reports Voluntary reports Risk assessment register SPIs/trend analysis Internal audits Quality programme reports Training records Service difficulty reports (SDR) In-service occurrence reports Maintenance and operational experience reports Service information reports (faults, malfunctions, defects) Unapproved parts reports
Organisations responsible for type design or manufacture of aircraft, engines or propellers	Mandatory occurrence reports, voluntary reports, risk assessment register SPIs/trend analysis Internal audits Service difficulty reports (SDR) Maintenance and operational experience reports
Air traffic services (ATS) providers	Mandatory occurrence reports Voluntary reports Risk assessment register SPIs/trend analysis Internal audits Special air-report (AIREPs) Training records Communication records
Operators of certified aerodromes	Mandatory occurrence reports Voluntary reports Risk assessment register SPIs/trend analysis Aerodromes safety report Internal audits Inspections of the movement area

Source: Author according to (ICAO, 2018)

Results of interactions between State representatives and service providers (aviation organisations), such as inspections, audits, or surveys, can also be a useful input to the pool of safety data and safety information. The safety data and safety information from these can be used as evidence of the efficacy of the surveillance programme itself.

Much of the safety data and safety information used as the basis for decision-making comes from routine, everyday operations which are available from within the organisation. The organisation should first identify what specific question the safety data and safety information

aim to answer or what problem needs to be addressed. This helps in determining the appropriate source and clarify the amount of data or information needed.

Safety data should ideally be categorized using taxonomies and supporting definitions so that the data can be captured and stored using meaningful terms. Common taxonomies and definitions establish a standard language, improving the quality of information and communication. The aviation community's capacity to focus on safety issues is greatly enhanced by sharing a common language. Taxonomies enable analysis and facilitate information sharing and exchange. Some examples of taxonomies include database with all models of aircraft certified to operate, database with ICAO or IATA codes to identify airports, or database with occurrence classification. There are a number of industry common aviation taxonomies. Some examples include Accident Data Reporting (ADREP), Commercial Aviation Safety Team (CAST)/International Civil Aviation Organisation (ICAO) Common Taxonomy Team (CICTT), and Safety Performance Indicators Task Force (SPI-TF) (ICAO, 2018).

As per (ICAO, 2018), safety data processing refers to the manipulation of safety data to produce meaningful safety information in useful forms such as diagrams, reports, or tables. There are a number of important considerations related to safety data processing, including: data quality, aggregation, fusion, and filtering.

Data quality relates to data that is clean and fit for purpose. Data quality involves the following aspects: cleanliness, relevance, timeliness, accuracy, and correctness.

Data aggregation is when safety data and safety information is gathered and stored in the organisation's SDCPS and expressed in a summary form for analysis.

Data fusion is the process of merging multiple safety data sets to produce more coherent, linked and useful safety data than that provided by any individual set of safety data. The integration of safety data sets followed by its reduction or replacement improves the reliability and usability of said data. Hence, for example, data from FDA systems of air operators could be merged with meteorological data and radar data to obtain a more useful data set for further processing.

Safety data filtering refers to a wide range of strategies or solutions for refining safety data sets. This means the data sets are refined into simply what the decision-maker needs, without including other data that can be repetitive, irrelevant or even sensitive. Different types of data filters can be used to generate reports or present the data in ways that facilitate communication.

Safety data and safety information management can be defined as the development, execution and supervision of plans, policies, programmes and practices that ensure the overall integrity, availability, usability, and protection of the safety data and safety information used by the organisation.

Safety data and safety information management which addresses the necessary functions will ensure that the organisation's safety data and safety information is collected, stored, analysed, retained and archived, as well as governed, protected and shared, as intended. Specifically, it should identify: what data will be collected; data definitions, taxonomy and formats; how the data will be collected, collated and integrated with other safety data and safety information sources; how the safety data and safety information will be stored, archived and backed up; for

example, database structure, and, if an IT system, supporting architecture; how the safety data and safety information will be used; how the information is to be shared and exchanged with other parties; how the safety data and safety information will be protected, specific to the safety data and safety information type and source; and how quality will be measured and maintained.

Without clearly defined processes to produce safety information, an organisation cannot achieve defensible, reliable, and consistent information upon which data-driven decisions are confidently made.

Data governance is the authority, control and decision-making over the processes and procedures that support an organisation's data management activities. It dictates how safety data and safety information are collected, analysed, used, shared and protected. Data governance ensures that the data management system(s) has the desired effect through the key characteristics of integrity, availability, usability and protection.

Metadata is defined as a set of data that describes and gives information about other data, in other words, data about data. Using metadata standards provides a common meaning or definition of the data. It ensures proper use and interpretation by owners and users, and that data is easily retrieved for analysis. Metadata provides a common understanding of what the data is and ensures correct use and interpretation by its owners and users. It can also identify errors in the data collection which leads to continuous improvements of the program.

### **3.2 Safety data analysis**

Safety analysis is the process of applying statistical or other analytical techniques to check, examine, describe, transform, condense, evaluate, and visualize safety data and safety information in order to discover useful information, suggest conclusions and support decision-making (ICAO, 2018). Analysis helps organisations to generate actionable safety information in the form of statistics, graphs, maps, dashboards, and presentations. Safety analysis is especially valuable for large organisation with rich safety data. Safety analysis relies on the simultaneous application of statistics, computing and operations research. The result of a safety analysis should present the safety situation in ways that enable decision makers to make safety decisions.

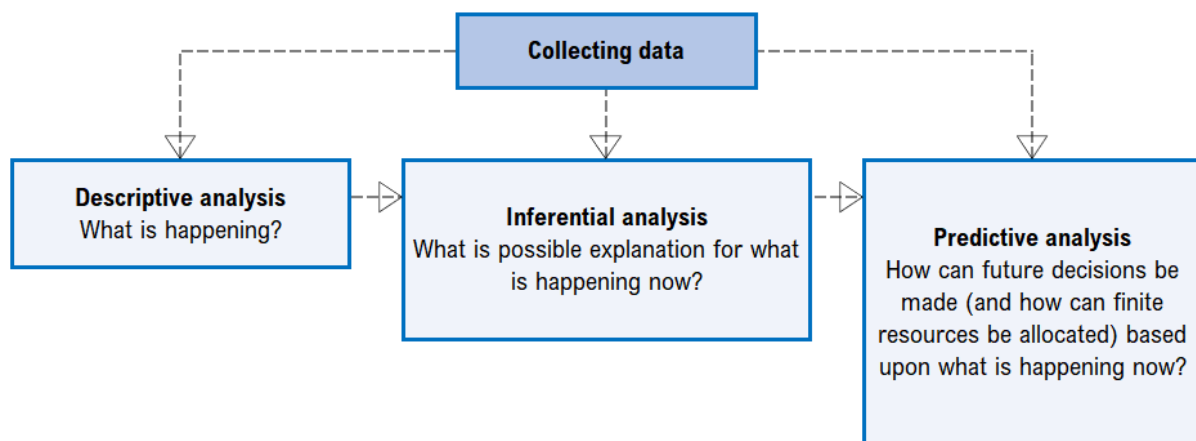
In parallel with the human resourcing considerations should be an analysis of the existing software, and business and decision-making policies and processes. To be effective, the safety analysis should be integrated with the organisation's existing core tools, policies, and processes. Once amalgamated, the ongoing development of safety intelligence should be seamless and part of the organisation's usual business practice.

Safety data and safety information analysis can be conducted in many ways, some requiring more robust data and analytic capabilities than others. The use of suitable tools for analysis of safety data and safety information provides a more accurate understanding of the overall situation by examining the data in ways that reveal the existing relationships, connections, patterns, and trends that exist within.

An organisation with a mature analysis capability is better able to: establish effective safety metrics; establish safety presentation capabilities (e.g., safety dashboard) for ready interpretation of safety information by decision makers; monitor safety performance of a given sector, organisation, system, or process; highlight safety trends, safety targets; alert safety decision makers, based on safety triggers; identify factors that cause change; identify connections or „correlations” between or among various factors; test assumptions; and develop predictive modelling capabilities.

Organisations should include a range of appropriate information sources in their safety analysis, not just „safety data”. Examples of useful additions to the data set include weather, terrain, traffic, demographics, geography, etc. Having access to and exploiting a broader range of data sources will ensure analysts and safety decision makers are aware of the bigger picture, within which the safety decisions are made.

Analysis of safety data and safety information also allows decision makers to compare information to other groups (i.e., a control or comparison group) to help draw conclusions from the safety data. Common approaches include descriptive analysis (describing), inferential analysis (inferring) and predictive analysis (predicting), as illustrated in Figure 11.



**Figure 11 Types of analysis**  
 Source: Author according to (ICAO, 2018)

Results of safety data analysis can highlight areas of high safety risk and assist decision makers and managers to take immediate corrective actions; implement safety risk-based surveillance; define or refine safety policy or safety objectives; define or refine SPIs and SPTs; set SPI triggers; promote safety; and conduct further safety risk assessment.

It is helpful to translate recommendations into action plans, decisions and priorities that decision makers in the organisation must consider and, if possible, to outline who needs to do what about the analysis results and by when. Visualization tools such as charts, graphs, images and dashboards are simple yet effective means of presenting results of data analysis.



### 3.2.1 Descriptive analysis

Descriptive statistics are used to describe or summarize data in ways that are meaningful and useful. They help describe, show, or summarize data in ways so patterns can emerge from the data and help to clearly define case studies, opportunities and challenges. Descriptive techniques provide information about the data; however, they do not allow users to make conclusions beyond the analysed data or to reach conclusions regarding any hypotheses about the data. They are a way to describe the data.

Descriptive statistics are helpful because if we simply presented the raw data, particularly in large quantities, it would be hard to visualize what the data is showing. Descriptive statistics enable users to present and see the data in a more meaningful way, allowing simpler interpretation of the data. Tools such as tables and matrices, graphs, and charts and even maps are examples of tools used for summarizing data. Descriptive statistics include measures of central tendency such as mean (average), median and mode, as well as measures of variability such as range, quartiles, minimum and maximum, frequency distributions, variance, and standard deviation (SD). These summaries may either be the initial basis for describing the data as part of a more extensive statistical analysis or they may be sufficient in and of themselves for a particular investigation (ICAO, 2018).

### 3.2.2 Inferential analysis

Inferential (or inductive) statistics aim to use the data to learn about the larger population the sample of data represents. It is not always convenient or possible to examine each item of an entire population and to have access to a whole population. Inferential statistics are techniques that allow users of available data to generalize, make inferences and conclusions about the population from which the samples were taken to describe trends (Glymour, et al., 1996). These include methods for estimating parameters, testing of statistical hypotheses, comparing the average performance of two groups on the same measure to identify differences or similarities, and identifying possible correlations and relationships among variables.

### 3.2.3 Predictive analysis

Other types of analyses include probability or predictive analyses that extract information from historical and current data and use it to predict trends and behaviour patterns. The patterns found in the data help identify emerging risks and opportunities. Often the unknown event of interest is in the future, but predictive analysis can be applied to any type of unknown in the past, present or future (Lališ, et al., 2018). The core of predictive analysis relies on capturing relationships between variables from past occurrences and exploiting them to predict the unknown outcome. Some systems allow users to model different scenarios of risks or opportunities with different outcomes (Lališ, et al., 2018). This enables decision makers to

assess the decisions they can make in the face of different unknown circumstances and to evaluate how they can effectively allocate limited resources to areas where the highest risks or best opportunities exist.

#### 3.2.4 Combined analysis

Various types of statistical analyses are interconnected and often conducted together. For example, an inferential technique may be the main tool used to draw conclusions regarding a set of data, but descriptive statistics are also usually used and presented. Also, outputs of inferential statistics are often used as the basis for predictive analysis.

Analytical techniques can be applied to safety analysis in order to identify the causes and contributing factors related to hazards and elements which are crucial to the continuous improvement of aviation safety. Analytical techniques can also be applied to examine areas for improvement and increase in the effectiveness of safety controls, as well to support ongoing monitoring of safety performance and trends.

### 3.3 Data-driven decision-making

As per (ICAO, 2018), the primary purpose of safety analysis and safety reporting is to present a picture of the safety situation to decision makers which will empower them to make decisions based on the data presented. This is known as data-driven decision-making (DDDM or D3M), a data-driven approach to decision-making.

Having a solid foundation of safety data and safety information is fundamental for safety management since it is the basis for data-driven decision-making.

Many aviation occurrences have resulted, at least in part, from poor management decisions, which can result in wasted money, labour and resources. The goal of safety decision makers is, in the short term, to minimize poor outcomes and achieve effective results, and in the long term, to contribute to the achievement of the organisation's safety objectives.

Good decision-making is not easy. Decisions are often made without being able to consider all the relevant factors. Decision makers are also subject to bias that, whether consciously or not, affects decisions made.

The intent of D3M is not necessarily to make the „perfect” or ideal decision, but rather to make a good decision that achieves the short-term objective (about which the actual decision is being made) and works towards satisfying the longer-term objective (improved organisational safety performance). Good decisions meet the following criteria: transparency, accountability, fairness and objectivity, justification, reproducibility, executability, and pragmatism.

### 3.3.1 Advantages of data-driven decision-making

D3M enables decision makers to focus on desired safety outcomes which align with the safety policy and objectives, and address various aspects related to change management, safety risk assessments, etc. D3M can assist with decisions related to:

- changes that can be expected in statutory and regulatory requirements, emerging technologies or resources which may affect the organisation;
- potential changes in the needs and expectations of the aviation community and interested parties;
- various priorities that need to be established and managed (e.g., strategic, operational, resources);
- new skills, competencies, tools and even change management processes that may be needed to implement new decision(s);
- risks that must be assessed, managed, or minimized;
- existing services, products and processes that currently provide the most value for interested parties; and
- evolving demands for new services, products, and processes (ICAO, 2018).

A structured approach such as D3M drives decision makers to decisions that are aligned with what the safety data is indicating. This requires trust in the safety performance management framework; if there is confidence in it, there will be trust in any decisions derived from it.

### 3.3.2 Challenges with data-driven decision-making

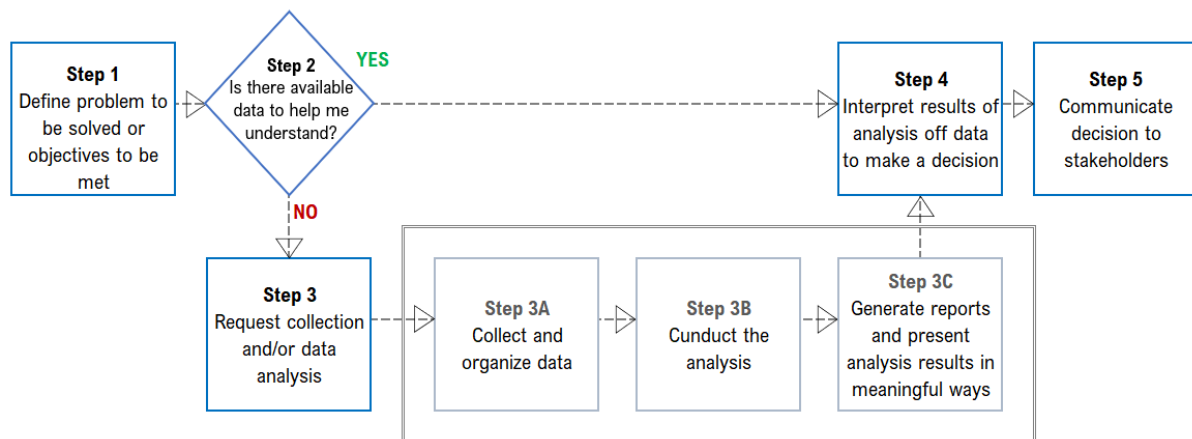
As per (ICAO, 2018), implementing processes for data collection and analysis takes time and money, as well as expertise and skills that may not be readily available to the organisation. The appropriate amount of time and resources vested into the decision-making process needs to be carefully considered. Factors to consider include the amount of money involved in the decision, the extent of the influence of the decision and the decision's safety permanence. If the organisation does not understand what is involved, then the D3M process may become a source of frustration for safety decision makers, causing them to undermine or abandon the process. Like SSP, SMS, D3M and safety performance management require a commitment to build and sustain the structures and skills necessary to maximize the opportunities presented by D3M.

It is harder to build trust in data than it is to trust an expert's input and opinion. Adopting the D3M approach requires a shift in the culture and mindset of the organisation where decisions are based upon reliable SPIs and the results of other safety data analysis.

In some cases, the decision-making process may become bogged down in an attempt to find the „best possible” solution, also known as „analysis paralysis”. Strategies that can be used to avoid this include setting a deadline; having a well-defined scope and objective; and not aiming for a „perfect” decision or solution the first time, but rather coming up with a „suitable” and „practical” decision and improving further decisions.

### 3.3.3 Data-driven decision-making process

The D3M process can be a critical tool that increases the value and effectiveness of the SSP and SMS. Effective safety management depends on making defensible and informed decisions. In turn, effective D3M relies on clearly defined safety data and information requirements, standards, collection methods, data management, analysis and sharing, all of which are components of a D3M process (ICAO, 2018). Figure 12 illustrates the D3M process.



**Figure 12 Data-driven decision-making process**

*Source: Author according to (ICAO, 2018)*

The first step in planning and establishing the D3M process is called „Defining the problem or objective”, as it defines the problem that needs to be solved or the safety objective that must be achieved. What is the question that needs to be answered? What decision must the safety decision makers make? How will it align with the more strategic organisational objectives?

The second step is called „Access to data to support the decision-making”, and it identifies what data is needed to answer the problem (considering the provisions on information protection). No data is any more valuable than other data. Focus should be on whether the available data is appropriate to help answer and resolve the problem. If the data required is available, the process can continue to fourth step.

If the right data is not available, the organisation will need to collect, store, analyse and present new safety data and safety information in meaningful ways. This represents third step called „Request data to support the decision-making”. This may mean establishing another SPI and perhaps aligned SPTs. Establishing additional indicators can come at a cost. Once the cost is known, the organisation should estimate if the benefits outweigh those costs. The focus should primarily be on identifying, monitoring, and measuring safety data that is needed to make effective data-driven safety decisions. If the costs outweigh the benefits, consider alternative data sources and/or indicators.

Fourth step is called „Interpret results of data analysis and make data-driven decision“. The data gathered must be presented to the decision makers at the right time and in meaningful ways. The appropriateness and size of the data sets, the sophistication of the analytics and the skills of the data analysts will only be effective if the data is presented when needed and in formats that make it easy for decision makers to comprehend. The insights gained from the data should inform decision-making, and ultimately, improve safety performance.

Last (fifth) step is called „Communicate the decision“. For the safety decision to be effective, it needs to be communicated to stakeholders, these include staff required to enact the necessary actions; person who reported the situation (if required); all personnel, to ensure they are kept informed of safety improvements; and organisational knowledge managers to ensure the safety decision is incorporated into the learning of the organisation.

### 3.3.4 Safety performance management and data-driven decision-making

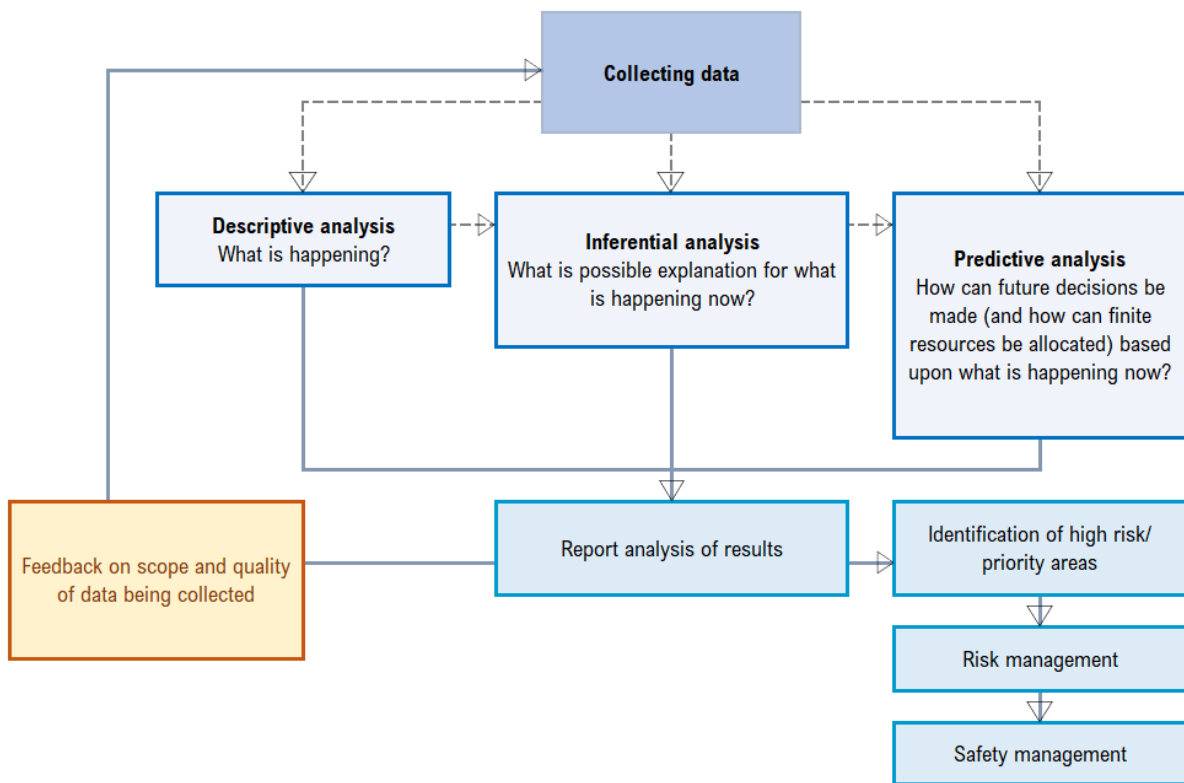
As per (ICAO, 2018), the following elements combine to enable an organisation to identify trends, make informed decisions, evaluate the safety performance in relation to defined objectives, assess risks or fulfil its requirements: safety performance management – as the safety data and safety information governance framework; SDCPS – as the safety data collection and processing functionality; and D3M as a dependable decision-making process.

The most important outcome of establishing a safety performance management structure is the presentation of information to the organisation’s decision makers so they can make decisions based on current, reliable safety data and safety information. The aim should always be to make decisions in accordance with the safety policy and towards the safety objectives.

In relation to safety performance management, data-driven decision-making is about making effective, well-informed decisions based on the results of monitored and measured SPIs, or other reports and analysis of safety data and safety information. Using valid and relevant safety data combined with information that provides context supports the organisation in making decisions that align with its safety objectives and targets. Contextual information may also include other stakeholder priorities, known deficiencies in the data, and other complementary data to evaluate the pros, cons, opportunities, limitations, and risks associated with the decision. Having the information readily available and easy to interpret helps to mitigate bias, influence, and human error in the decision-making process.

Data-driven decision-making also supports the evaluation of decisions made in the past to support any realignment with the safety objectives.

Collecting and analysing the data required for effective management and decision-making is an ongoing process. The results of data analysis may reveal that more and better data must be collected and analysed in support of the actions and decisions that the organisation needs to take. Figure 13 shows how reporting of analysis results may determine further requirements for data to be collected.



**Figure 13 Data-driven decision making and safety performance management**

*Source: Author according to (ICAO, 2018)*

### 3.4 Safety objectives

Establishing safety objectives provides strategic direction for the safety performance management process and provides a sound basis for safety-related decision-making. The management of safety performance should be a primary consideration when amending policies or processes or allocating the organisation's resources in pursuit of improving safety performance.

Safety objectives are brief, high-level statements of safety achievements or desired outcomes to be accomplished. Safety objectives provide direction to the organisation's activities and should therefore be consistent with the safety policy that sets out the organisation's high-level safety commitment. They are also useful to communicate safety priorities to personnel and the aviation community as a whole.

As per (ICAO, 2018), safety objectives may be:

- process-oriented: stated in terms of safe behaviours expected from operational personnel or the performance of actions implemented by the organisation to manage safety risk; or

- outcome-oriented: encompass actions and trends regarding containment of accidents or operational losses.

The suite of safety objectives should include a mix of both process-oriented and outcome-oriented objectives to provide enough coverage and direction for the SPIs and SPTs. Safety objectives on their own, do not need to be Specific, Measurable, Achievable, Relevant and Timely (SMART) (Doran, 1981), provided the safety objectives and accompanying SPIs and SPTs form a package that allows an organisation to demonstrate whether it is maintaining or improving its safety performance.

An organisation may also choose to identify safety objectives at the tactical or operational level or apply them to specific projects, products, and processes (Table 6). A safety objective may also be expressed by the use of other terms with a similar meaning (e.g., goal or target).

**Table 6 Examples of safety objectives**

Examples of safety objectives		
process-oriented	State or service provider	Increase safety reporting levels.
outcome-oriented	service provider	Reduce rate of adverse apron safety events. (high-level) or Reduce the annual number of adverse apron safety events from the previous year.
outcome-oriented	State	Reduce the annual number of safety events in sector X.

*Source: Author according to (ICAO, 2018)*

Understanding how the organisation plans to progress towards its safety objectives requires that they know where they are, in relation to safety. Once the organisation's safety performance structure (safety objectives, indicators, targets, triggers) has been established and is functioning, it is possible to learn their baseline safety performance through a period of monitoring. Baseline safety performance is the safety performance at the commencement of the safety performance measurement process, the point from which progress can be measured.

### **3.5 Safety performance indicators**

As defined by ICAO (ICAO, 2018), SPIs are used to help senior management know whether or not the organisation is likely to achieve its safety objective; they can be qualitative or quantitative. Quantitative indicators relate to measuring by the quantity, rather than its quality, whereas qualitative indicators are descriptive and measure by quality.

### 3.5.1 Qualitative and quantitative safety performance indicators

Quantitative indicators are preferred over qualitative indicators because they are more easily counted and compared. The choice of indicator depends on the availability of reliable data that can be measured quantitatively (Roelen & Klompstra, 2012). Does the necessary evidence have to be in the form of comparable, generalizable data (quantitative), or a descriptive image of the safety situation (qualitative)? Each option, qualitative or quantitative, involves different kinds of SPIs, and requires a thoughtful SPI selection process (Lališ & Vittek, 2014). A combination of approaches is useful in many situations and can solve many of the problems which may arise from adopting a single approach. An example of a qualitative indicator for a State could be the maturity of their service providers' SMS in a particular sector, or for a service provider the assessment of the safety culture.

Quantitative indicators can be expressed as a number ( $x$  incursions) or as a rate ( $x$  incursions per  $n$  movements). In some cases, a numerical expression will be sufficient. However, just using numbers may create a distorted impression of the actual safety situation if the level of activity fluctuates. For example, if air traffic control records three altitude busts in July and six in August, there may be great concern about the significant deterioration in safety performance. But August may have seen double the movements of July meaning the altitude busts per movement, or the rate, has decreased, not increased. This may or may not change the level of scrutiny, but it does provide another valuable piece of information that may be vital to data-driven safety decision-making.

For this reason, where appropriate, SPIs should be reflected in terms of a relative rate to measure the performance level regardless of the level of activity. This provides a normalized measure of performance; whether the activity increases or decreases. As another example, an SPI could measure the number of runway incursions. But if there were fewer departures in the monitored period, the result could be misleading. A more accurate and valuable performance measure would be the number of runway incursions relative to the number of movements, e.g.,  $x$  incursions per 1,000 movements.

### 3.5.2 Lagging and leading indicators

The two most common categories used by States and service providers to classify their SPIs are lagging and leading. Lagging SPIs measure events that have already occurred. They are also referred to as „outcome-based SPIs” and are normally (but not always) the negative outcomes the organisation is aiming to avoid. Leading SPIs measure processes and inputs being implemented to improve or maintain safety (Leveson, 2015). These are also known as „activity or process SPIs” as they monitor and measure conditions that have the potential to lead to or contribute to a specific outcome.

Lagging SPIs help the organisation understand what has happened in the past and are useful for long-term trending. They can be used as a high-level indicator or as an indication of specific



occurrence types or locations, such as „types of accidents per aircraft type” or „specific incident types by region”. Because lagging SPIs measure safety outcomes, they can measure the effectiveness of safety mitigations. They are effective at validating the overall safety performance of the system. For example, monitoring the „number of ramp collisions per number of movements between vehicles following a redesign of ramp markings” provides a measure of the effectiveness of the new markings (assuming nothing else has changed). The reduction in collisions validates an improvement in the overall safety performance of the ramp system; which may be attributable to the change in question.

Trends in lagging SPIs can be analysed to determine conditions existing in the system that should be addressed. Using the previous example, an increasing trend in ramp collisions per number of movements may have been what led to the identification of sub-standard ramp markings as a mitigation.

Lagging SPIs are divided into two types:

- low probability/high severity: outcomes such as accidents or serious incidents. The low frequency of high severity outcomes means that aggregation of data (at industry segment level or regional level) may result in more meaningful analyses. An example of this type of lagging SPI would be „aircraft and/or engine damage due to bird strike”.
- high probability/low severity: outcomes that did not necessarily manifest themselves in a serious accident or incident, these are sometimes also referred to as precursor indicators. SPIs for high probability/low severity outcomes are primarily used to monitor specific safety issues and measure the effectiveness of existing safety risk mitigations. An example of this type of precursor SPI would be „bird radar detections”, which indicates the level of bird activity rather than the amount of actual bird strikes.

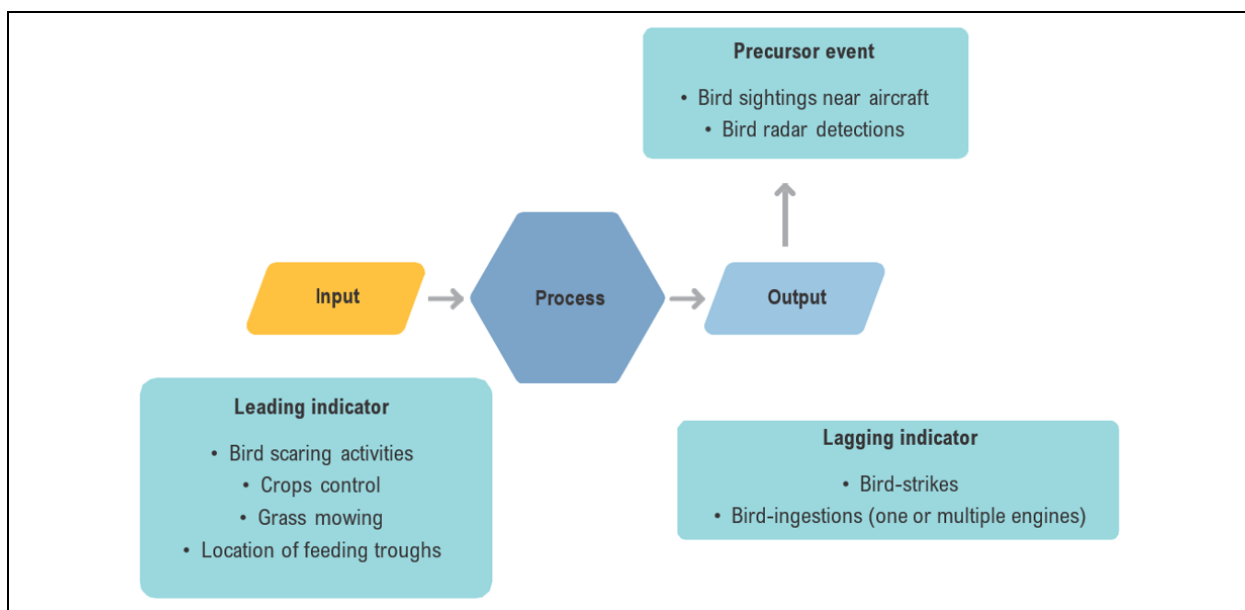
Aviation safety measures have historically been biased towards SPIs that reflect „low probability/high severity” outcomes. This is understandable in that accidents and serious incidents are high profile events and are easy to count. However, from a safety performance management perspective, there are drawbacks in an overreliance on accidents and serious incidents as a reliable indicator of safety performance. For instance, accidents and serious incidents are infrequent (there may be only one accident in a year, or none) making it difficult to perform statistical analysis to identify trends. This does not necessarily indicate that the system is safe. A consequence of a reliance on this sort of data is a potential false sense of confidence that organisational or system’s safety performance is effective when it may in fact be very close to an accident.

Leading indicators are measures that focus on processes and inputs that are being implemented to improve or maintain safety. These are also known as „activity or process SPIs” as they monitor and measure conditions that have the potential to become or to contribute to a specific outcome.

Examples of leading SPIs driving the development of organisational capabilities for proactive safety performance management include such things as „percentage of staff who have successfully completed safety training on time” or „frequency of bird scaring activities”.

Leading SPIs may also inform the organisation about how their operation copes with change, including changes in its operating environment. The focus will be either on anticipating weaknesses and vulnerabilities as a result of the change or monitoring the performance after a change. An example of an SPI to monitor a change in operations would be „percentage of sites that have implemented procedure X”.

For a more accurate and useful indication of safety performance, lagging SPIs, measuring both „low probability/high severity” events and „high probability/low severity” events should be combined with leading SPIs. Figure 14 illustrates the concept of leading and lagging indicators that provide a more comprehensive and realistic picture of the organisation’s safety performance.



**Figure 14 Leading and lagging indicators**  
*Source: (ICAO, 2018)*

### 3.5.3 Selection of safety performance indicators

SPIs are the parameters that provide the organisation with a view of its safety performance: where it has been; where it is now; and where it is headed, in relation to safety. This picture acts as a solid and defensible foundation upon which the organisation’s data-driven safety decisions are made. These decisions, in turn, positively affect the organisation’s safety performance. The identification of SPIs should therefore be realistic, relevant, and linked to safety objectives, regardless of their simplicity or complexity (Ioannou, et al., 2017).

It is likely the initial selection of SPIs will be limited to the monitoring and measurement of parameters representing events or processes that are easy and/or convenient to capture (safety data that may be readily available) (Panagopoulos, et al., 2017). Ideally, SPIs should focus on

parameters that are important indicators of safety performance, rather than on those that are easy to attain.

SPIs should be related to the safety objective they aim to indicate; selected or developed based on available data and reliable measurement; appropriately specific and quantifiable; and realistic, by considering the possibilities and constraints of the organisation (Chen, et al., 2021).

A combination of SPIs is usually required to provide a clear indication of safety performance. There should be a clear link between lagging and leading SPIs. Ideally lagging SPIs should be defined before determining leading SPIs. Defining a precursor SPI linked to a more serious event or condition (the lagging SPI) ensures there is a clear correlation between the two. All of the SPIs, lagging and leading, are equally valid and valuable.

It is important to select SPIs that relate to the organisation's safety objectives. Having SPIs that are well defined and aligned will make it easier to identify SPTs, which will show the progress being made towards the attainment of safety objectives. This allows the organisation to assign resources for greatest safety effect by knowing precisely what is required, and when and how to act to achieve the planned safety performance. For example, a State has a safety objective of „reduce the number of runway excursions by 50% in three years” and an associated, well-aligned SPI of „number of runway excursions per million departures across all aerodromes”. If the number of excursions drops initially when monitoring commences, but starts to climb again after twelve months, the State could choose to reallocate resources away from an area where, according to the SPIs, the safety objective is being easily achieved and towards the reduction of runway excursions to alleviate the undesirable trend (ICAO, 2018).

The contents of each SPI should include:

- a description of what the SPI measures,
- the purpose of the SPI (what it is intended to manage and who it is intended to inform),
- the units of measurement and any requirements for its calculation,
- who is responsible for collecting, validating, monitoring, reporting and acting on the SPI (these may be staff from different parts of the organisation),
- where or how the data should be collected, and
- the frequency of reporting, collecting, monitoring and analysis of the SPI data.

### **3.6 Safety performance targets**

As per (ICAO, 2018), safety performance targets (SPTs) define short-term and medium-term safety performance management desired achievements. They act as „milestones” that provide confidence that the organisation is on track to achieving its safety objectives and provide a measurable way of verifying the effectiveness of safety performance management activities. SPT setting should take into consideration factors such as the prevailing level of safety risk, safety risk tolerability, as well as expectations regarding the safety of the particular aviation sector. The setting of SPTs should be determined after considering what is realistically

achievable for the associated aviation sector and recent performance of the particular SPI, where historical trend data is available.

If the combination of safety objectives, SPIs and SPTs working together are SMART, it allows the organisation to demonstrate its safety performance more effectively. There are multiple approaches to achieving the goals of safety performance management, especially, setting SPTs. One approach involves establishing general high-level safety objectives with aligned SPIs and then identifying reasonable levels of improvements after a baseline safety performance has been established. These levels of improvements may be based on specific targets (e.g., percentage decrease) or the achievement of a positive trend. Another approach which can be used when the safety objectives are SMART is to have the safety targets act as milestones to achieving the safety objectives. Either of these approaches are valid and there may be others that an organisation finds effective at demonstrating their safety performance. Different approaches can be used in combination as appropriate to the specific circumstances.

Once an organisation has identified the targets based on the SPIs they believe will deliver the planned outcome, they must ensure the stakeholders follow through by assigning clear responsibility for delivery. Defining SPTs for each aviation authority, sector and service provider supports the achievement of the ALoSP for the State by assigning clear accountability.

### 3.6.1 Setting targets with high-level safety objectives

Targets are established with senior management agreeing on high-level safety objectives. The organisation then identifies appropriate SPIs that will show improvement of safety performance towards the agreed safety objective(s). The SPIs will be measured using existing data sources but may also require the collection of additional data. The organisation then starts gathering, analysing, and presenting the SPIs. Trends will start to emerge, which will provide an overview of the organisation's safety performance and whether it is steering towards or away from its safety objectives. At this point the organisation can identify reasonable and achievable SPTs for each SPI (ICAO, 2018).

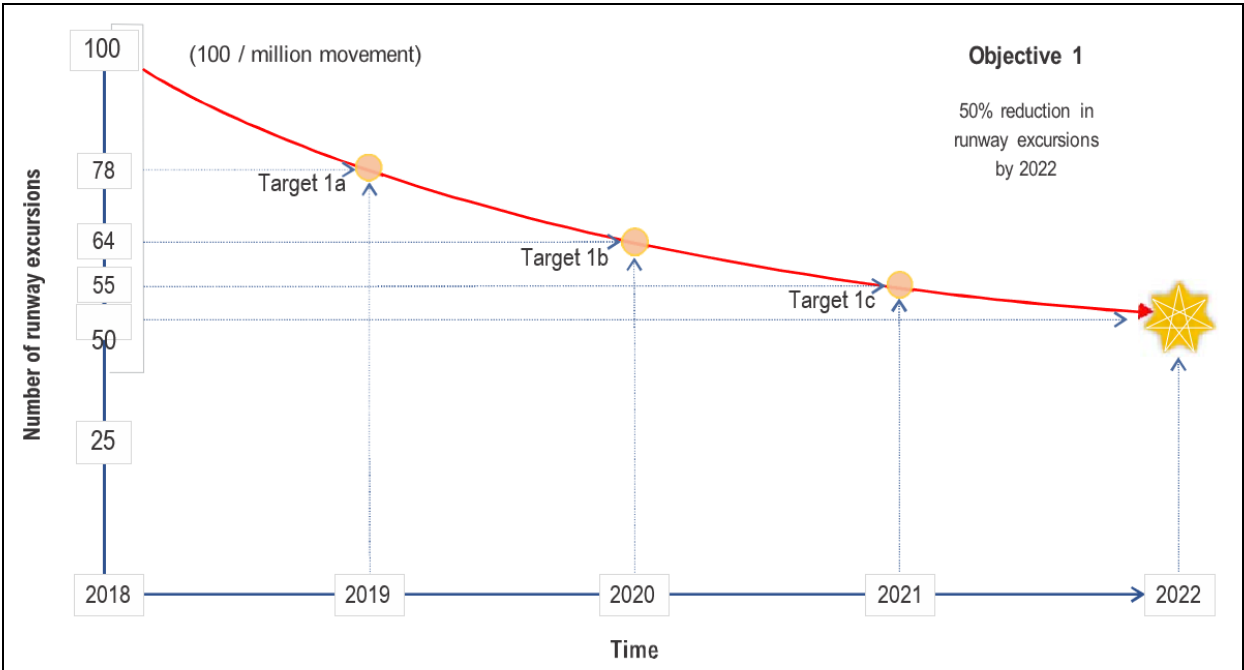
### 3.6.2 Setting targets with SMART safety objectives

Safety objectives can be difficult to communicate and may seem challenging to achieve; by breaking them down into smaller concrete safety targets, the process of delivering them is easier to manage. In this way, targets form a crucial link between strategy and day-to-day operations. Organisations should identify the key areas that drive the safety performance and establish a way to measure them. Once an organisation has an idea what their current level of performance is by establishing the baseline safety performance, they can start setting SPTs to give everyone in the State a clear sense of what they should be aiming to achieve. The organisation may also use benchmarking to support setting performance targets (Doran, 1981).

This involves using performance information from similar organisations that have already been measuring their performance to get a sense of how others in the community are doing.

As per (ICAO, 2018), an example of the relationship between safety objectives, SPIs and SPTs is illustrated in Figure 15. In this example, the organisation recorded 100 runway excursions per million movements in 2018. Specific targeted actions and associated timelines have been defined to meet these targets. To monitor, measure and report their progress, the organisation has chosen „RWY excursions per million movements per year” as the SPI. As shown in the Figure 15, the progress is expected to be greater in the first years and less so in the later years. In the Figure 15:

- the SMART safety objective is „50% reduction in RWY excursions rate by 2022”;
- the SPI selected is the „number runway excursions per million movements per year”;
- the safety targets related to this objective represent milestones for reaching the SMART safety objective and equate to approximately 12.5% reduction each year until 2022;
- SPT 1a is „less than 78 runway excursions per million movement in 2019”;
- SPT 1b is „less than 64 runway excursions per million movement in 2020”;
- SPT 1c is „less than 55 runway excursions per million movement in 2021”.



**Figure 15 Example of safety performance targets with safety objectives**  
*Source: Author according to (ICAO, 2018)*

It is not always necessary or appropriate to define SPTs as there may be some SPIs that are better to monitor for trends rather than use to determine a target. Safety reporting is an example of when having a target could either discourage people not to report (if the target is not to exceed a number) or to report trivial matters to meet a target (if the target is to reach a certain

number). There may also be SPIs better used to define a direction of travel to target continuous safety performance improvement (i.e., to reduce the number of events) rather than used to define an absolute target, as these may be difficult to determine (ICAO, 2018).

### 3.7 Safety triggers

A brief perspective on the notions of triggers is relevant to assist in their eventual role within the context of the management of safety performance by an organisation.

As per (ICAO, 2018), a trigger is an established level or criteria value that serves to trigger (start) an evaluation, decision, adjustment or remedial action related to the particular indicator. One method for setting out-of-limits trigger criteria for SPTs is the use of the population standard deviation (STDEVP) principle. This method derives the standard deviation (SD) value based on the preceding historical data points of a given safety indicator. The SD value plus the average (mean) value of the historical data set forms the basic trigger value for the next monitoring period. Triggers provide early warnings which enable decision makers to make informed safety decisions, and thus improve safety performance. An example of trigger levels based on standard deviations (SDs) is provided at Figure 16. In this example, data-driven decisions and safety mitigation actions may need to be taken when the trend goes beyond +1SD or +2SD from the mean of the preceding period. Often the trigger levels (in this case +1SD, +2SD or beyond +2SD) will align with decision management levels and urgency of action.

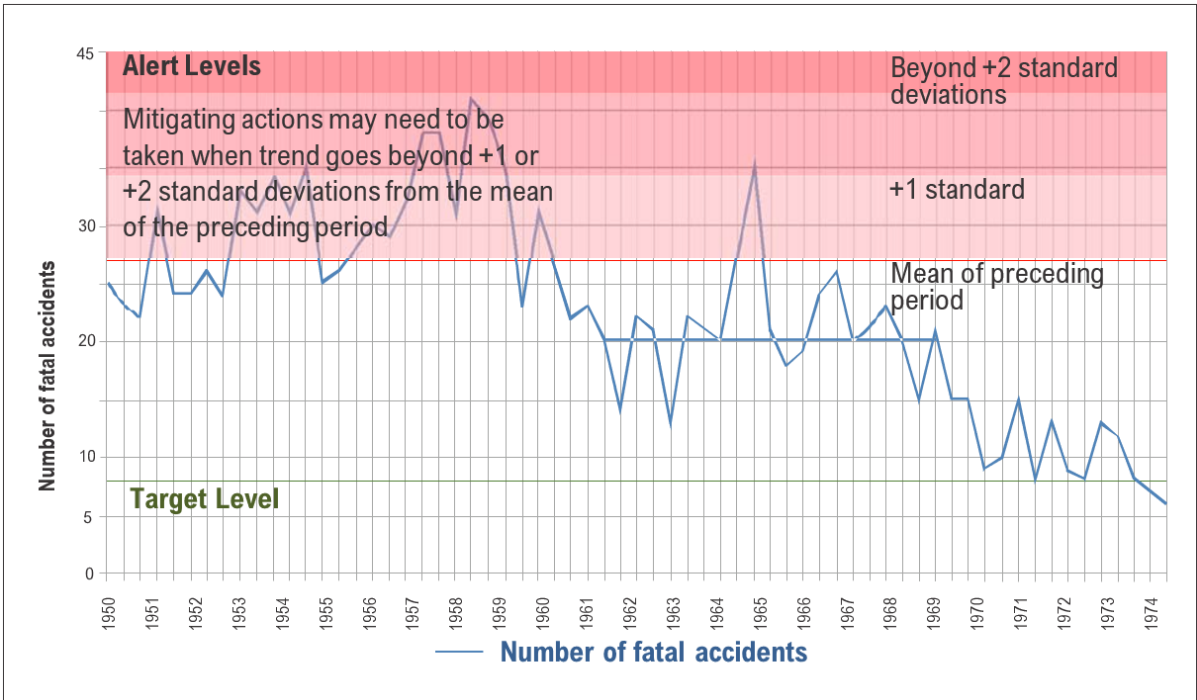
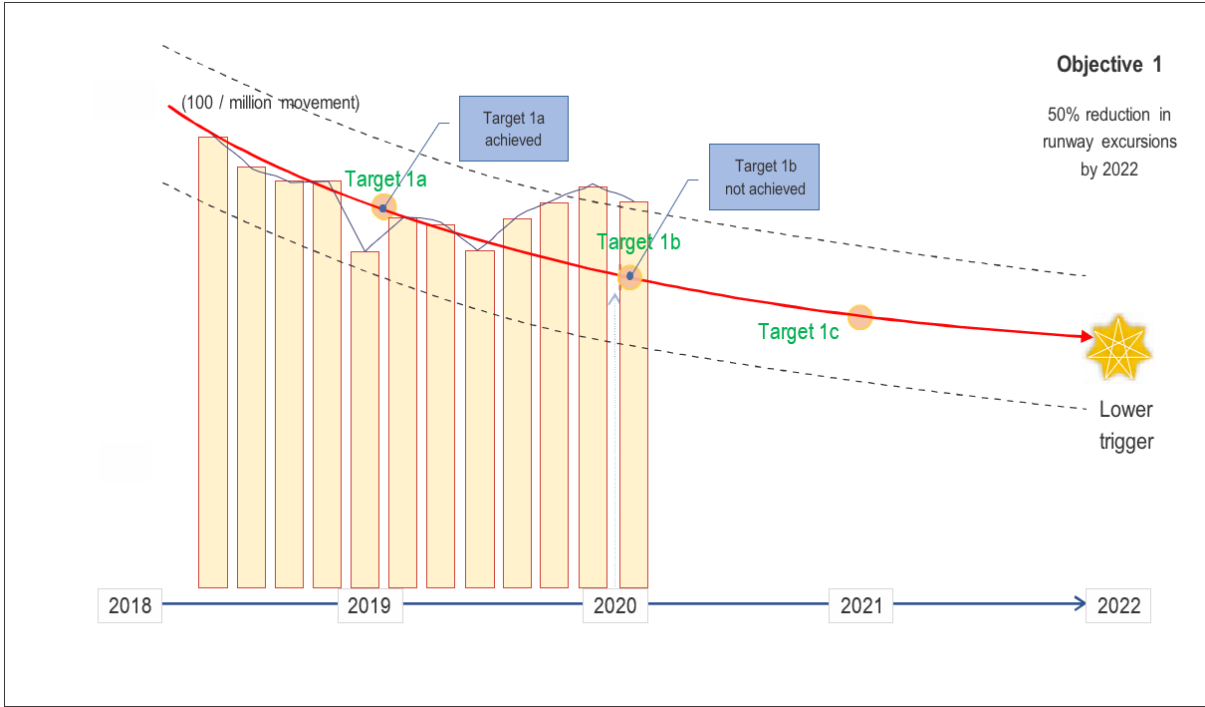


Figure 16 Example of representation of safety triggers/ alert levels  
 Source: (ICAO, 2018)

Figure 17 is an extension of the previous example, „50% reduction in runway excursions by 2022”. In this scenario, it is now the year 2020. The organisation has been collecting safety data (SPI – „Number of runway excursions/million movement/year”) and working with stakeholders to reduce the instances. The SPT for 2019 (<78 runway excursions/million movement in year) was achieved. However, the SPI shows that, not only was the SPT for 2020 (<64 runway excursions/million movement in year) not achieved, but the number of excursions has also exceeded the trigger in two consecutive reporting periods. The decision makers have been alerted to the deterioration in safety performance and are in a position to make decisions based on the data to take further actions (ICAO, 2018).



**Figure 17 Example of setting safety triggers and monitoring achievement of targets**  
*Source: (ICAO, 2018)*

## 4 AVIATION SAFETY MANAGEMENT METHODOLOGIES AND APPLICABLE METHODS

### 4.1 Basic aviation safety management methodologies

The SMS defines three management methodologies: reactive, proactive, and predictive (Figure 18) (ICAO, 2016) (ICAO, 2018) (Miroslavljević, et al., 2008) (Oster Jr., et al., 2013) (Everdij, et al., 2006).

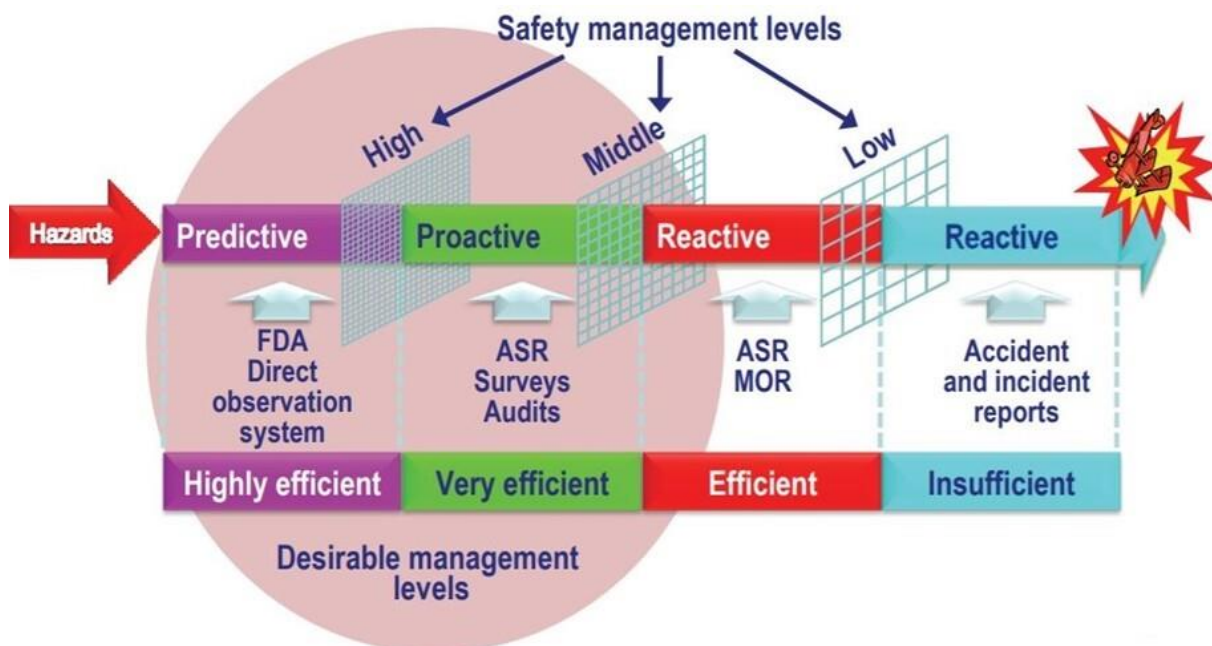


Figure 18 Safety management levels

Source: (ICAO, 2011)

All three methodologies are closely linked to all four components mentioned above, especially safety risk management component, in particularly hazard identification. The SMS needs input data to identify hazards, i.e., to be able to provide viable results and these methodologies are the SMS tool that enables it to acquire necessary safety data.

Reactive methodology gathers safety data from the accidents and incidents that has already occurred in the past and learns from their outcomes. Proactive methodology uses safety reporting systems and safety performance indicators to gather safety data in order to discover and mitigate the potential threats and hazards that may consequently trigger the occurrence of accident or incident. Predictive methodology is not yet well established, as it assumes discovering potential and possible hazards based on predictive analyses (forecasts) that extract information from historical and current safety data and use it to predict trends and behaviour patterns (Ancel, et al., 2015) (Čokorilo, et al., 2019) (ICAO, 2018) (Luxhøj, 2013) (Stanton, et al., 2008).



There are three categories of reports that are gathered: mandatory, voluntary and changes (CG, 2015). Mandatory reports refer to set of occurrences which are predetermined by the regulations with the obligation to report. Voluntary reports record potentially hazardous occurrences which are not predefined in the scope of mandatory occurrences. Reports on changes record every change that happens inside or outside the organisation, since every change represents potential hazard, and those reports can refer to internal changes (within organisation) or external changes (usually in regulations).

4.1.1 Reactive safety management methodology

Reactive methodology gathers safety data from the accidents and incidents that has already occurred in the past and learns from their outcomes. Mandatory report is made when occurrence has already happened, hence mandatory occurrence reporting can be characterised as reactive methodology of gathering safety data.

According to Civil Aviation Authority of Bangladesh (BCAA, 2010), „reactive navigation aids” require a very serious triggering even, with oftentimes considerable damaging consequences, to take place in order to launch the safety data capture process. The contribution of reactive navigation aids to safety management nevertheless depends on the extent to which the information they generate goes beyond the triggering causes of the event, and the allocation of blame, and includes contributory factors and findings as to safety risks (Bohm, 2008). The investigation of accidents and serious incidents are examples of reactive navigation aids. Other examples are situations involving failures in technology, or unusual events.

According to Cusick and Airbus Safety Magazine (Cusick, et al., 2017) (Airbus, 2014), definition of reactive methodology is: hazards are identified through investigation and analysis of past incidents or accidents, i.e., safety occurrences. Incidents and accidents are potential indicators of systems’ deficiencies and therefore can be used to determine the hazards that were contributing to the event or are latent.

An illustration of reactive safety management system and its most important activities is shown in Figure 19.



Figure 19 Reactive safety management system  
Source: Author

#### 4.1.2 Proactive safety management methodology

Proactive methodology uses safety reporting systems and safety performance indicators to gather safety data in order to discover and mitigate the potential threats and hazards that may consequently trigger the occurrence of accident or incident (Rasmussen & Svedung, 2000).

Voluntary reports and reports on changes record potential threats and hazards that could possibly or potentially lead to more serious occurrence, therefore those reports are characterised as proactive methodology of safety management.

Proactive methodology gathers safety data of occurrences or organisation's process performance and analyses the gathered safety data or its frequency to estimate if a hazard could cause an accident or incident (Patriarca, et al., 2019).

The main mechanism for safety data collection of proactive methodology is safety reporting system. Safety data can be collected from various types of safety reports such as: accident or incident investigations, voluntary safety reporting system, management of change, continuing airworthiness reports, operational performance monitoring (flight data analyses), inspections, audits, surveys, or safety studies and reviews.

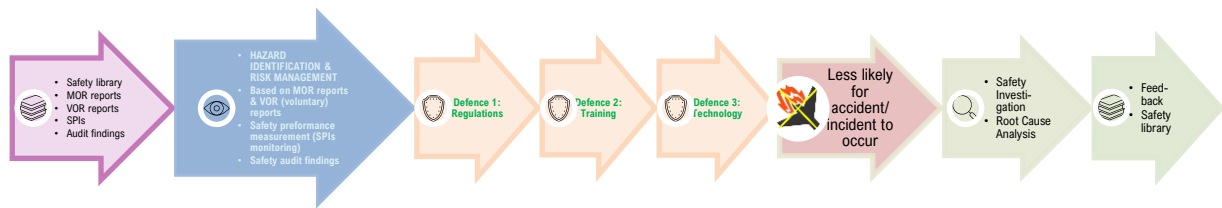
The main activity of proactive safety management methodology includes defining Safety Performance Indicators (SPIs) and setting of Safety Performance Targets (SPTs) (ICAO, 2018) (McDonald, et al., 2014).

SPIs are the parameters that give the organisation a clear view of its safety performance: where it has been; where it is now; and where it is headed, in relation to its safety performance. The set-up of SPIs should therefore be realistic, relevant, and linked to safety objectives of the organisation. Safety performance targets (SPTs) define desired achievements of safety performance in the organisation. They ensure that the organisation is on track to achieving its safety objectives and provide a measurable way of verifying the effectiveness of safety performance management activities. Both SPIs and SPTs provide clear picture of the organisation's safety performance.

As per Bohm and Cusick (Bohm, 2008) (Cusick, et al., 2017), proactive safety management: identifies safety risks within the system before it fails; and takes the necessary actions to reduce such safety risks.

According to Airbus Safety Magazine (Airbus, 2014), definition of proactive methodology is: hazards identification is made by analysis of the organisation's activities before hazards materialize into incidents or accidents and the necessary actions are taken to reduce the associated safety risks. A proactive process is based upon the notion that safety events can be minimized by identifying safety risks within the system before it fails and taking the necessary actions to mitigate such safety risks.

An illustration of proactive safety management system and its most important activities is shown in Figure 20.



**Figure 20 Proactive safety management system**

*Source: Author*

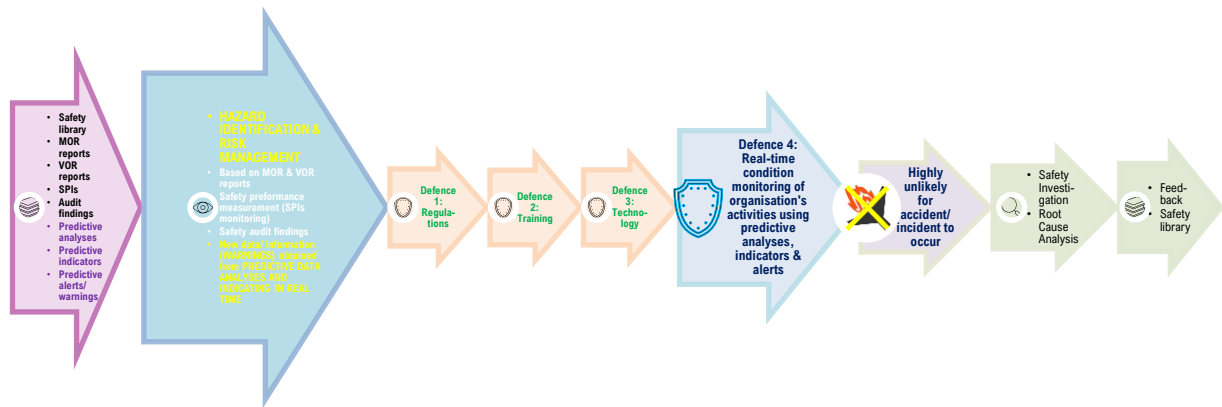
#### 4.1.3 Predictive safety management methodology

Predictive methodology is not yet well established, as it assumes discovering potential and possible hazards based on predictive analyses (forecasts) that extract information from historical and current safety data and use it to predict trends and behaviour patterns of emerging hazards (Ancel, et al., 2015) (Cusick, et al., 2017) (Čokorilo, et al., 2019) (ICAO, 2018) (Luxhøj, 2013) (Stanton, et al., 2008).

Predictive methodology of the SMS can use historical and current safety data, SPIs and SPTs of the organisation (Bartulović & Steiner, 2020) as the input information to conduct predictive analysis, i.e., forecasts using predictive (forecasting) methods. The obtained results show trends and behaviour patterns of established SPIs in the organisation and give improved picture of future development of safety performance in the organisation, as well as discovering emerging hazards.

As stated by Airbus Safety Magazine and Bangladesh Civil Aviation Authority (Airbus, 2014) (BCAA, 2010), predictive navigation aids do not require a triggering event to take place in order to launch the safety data capture process. Routine operational data are continually captured, in real time. Predictive navigation aids are based upon the notion that safety management is best accomplished by trying to find trouble, not just waiting for it to happen. Therefore, predictive safety data capture systems aggressively seek safety information that may be indicative of emerging safety risks for a variety of sources.

An illustration of predictive safety management system and its most important activities is shown in Figure 21.



**Figure 21 Predictive safety management system**

*Source: Author*

## 4.2 Application of predictive methods in aviation industry

This chapter gives the chronological overview of predictive methods used in aviation industry, with the purpose to improve safety in some aspects.

Some of predictive methods that can be used to analyse safety data are for example, linear trend analysis and moving average (GAIN, 2003) (Brockwell & Davis, 2016) (Bartulović & Steiner, 2020). The safety data can be historical safety data of the organisation to create forecasts or predictions of future behaviour of monitored parameters or indicators.

Pisanich and Corker (Pisanich & Corker, 1995) described Air-MIDAS, a model of pilot performance in interaction with varied levels of automation inflight management operations. The model was used to predict the performance of a two-person flight crew responding to clearance information generated by the Centre TRACON Automation System (CTAS). The model represents the information requirements, decision processes, communication processes, and motor performance required by the flight crew to integrate flight management automation and ground-side automation in clearance aiding. The paper described the model, its development and implementation, the simulation test of the model predictions, and the empirical validation process. The complex human performance model allows variations in CTAS design to be explored through predictive simulation. Procedures and performance criteria as well as situational variations can be controlled and tested. The model and its supporting data provide a generalizable tool that is being expanded to include air/ground compatibility and ATC crew interactions in air traffic management.

In 2003, Ghobbar & Friend dealt with techniques applicable to predicting spare parts demand for airline fleets. Authors devised a new approach to forecasting evaluation, a model which compares and evaluates forecasting methods based on their factor levels when faced with intermittent demand (Ghobbar & Friend, 2003).

Luxhøj described, in 2003, advanced risk analytics that combine the use of a human error taxonomy, probabilistic Bayesian Belief Networks, and case-based scenarios to assess a relative risk intensity metric, to reduce aviation safety system risk (Luxhøj, 2003). In 2005, Lechner & Luxhøj pointed out how frequency of commercial aircraft accidents is rare but modelling the precursors leading to those accidents is challenging, due to the intricacies of the system. Existing models of events when investigating the causes of accidents did not capture the probabilistic interdependencies of risk factors. They concluded that modelling of non-linear multiple causality and probabilistic dependencies would be a more realistic way of examining the accidents. Authors developed Aviation System Risk Model (ASRM) to provide advanced risk assessments for certain kinds of accidents. Described model uses Bayesian Belief Networks and influence diagrams to provide risk assessments, and it incorporates human factors analysis in evaluating the causes of accidents. To verify the model, a detailed study of three specific runway incursion accident cases, was presented (Lechner & Luxhøj, 2005). In 2006, Luxhøj & Coit presented an overview of an Aviation System Risk Model (ASRM) that assesses the impact of new technology insertions or products designed to mitigate the likelihood or consequence of aviation accidents. The ASRM, developed with joint support from the National Aeronautics and Space Administration (NASA) and the Federal Aviation Administration (FAA), was an example of a model devoted to class of „low probability/high consequence“ events. The ASRM was demonstrated with a model developed for a certain aircraft accident type known as controlled flight into terrain (CFIT) (Luxhøj & Coit, 2006).

Liou conducted (Liou, et al., 2008) a research to better understand the role that human factors play in major aviation accidents. A method for building an effective safety management system for airlines was developed that incorporates organisation and management factors. It combines both fuzzy logic and Decision-Making Trial and Evaluation Laboratory (DEMATEL). This method can map out the structural relations among diverse factors in a complex system and identify the key factors.

In 2011, Panagopoulos (Panagopoulos, 2011) conducted research regarding military pilot's error framework. The intent was to start to bridge and compare existent mostly reactive, Flight Safety programmes among NATO/EU Air Forces and show how a more proactive and predictive Safety Management System can be realised.

In 2011, Du & Qin described time-series extrapolation analysis model for short-term prediction of flight accidents in American general aviation (Du & Qin, 2011) and Valdés and others proposed risk models for runway overrun and landing undershoot, using a probabilistic approach. These models are supported by historical data on accidents in the area around the runway and will enable us to determine if the risk level is acceptable or whether action must be taken to mitigate such risks at a given airport. These models also enable comparison of the results of different risk mitigation actions in terms of operational risk and safety (Valdés, et al., 2011).

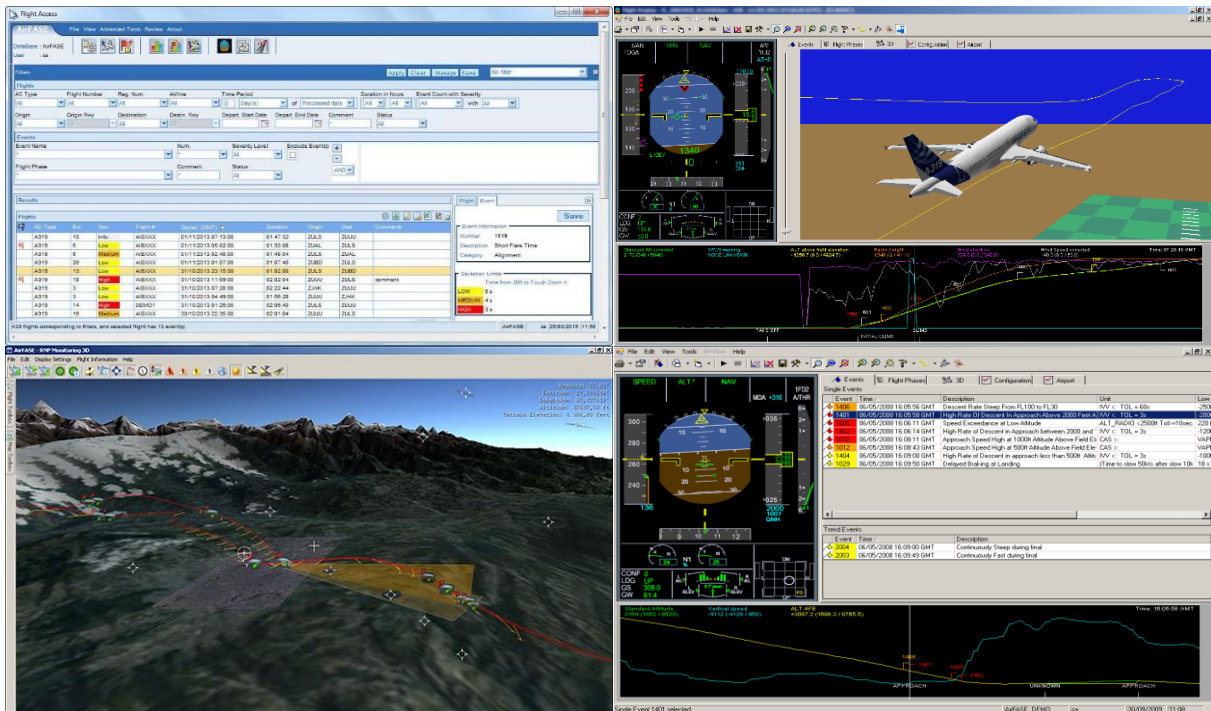
Boeing (Boeing, 2012) develops and incorporates new technologies to enhance safety. Through research, development and collaboration, Boeing has developed sophisticated technologies that provide distinct safety advantages, such as: Vertical Situation Display, predictive windshear

equipment along with improved windshear – training programs for pilots, and Enhanced Ground Proximity Warning System.

In 2013, Duanmu and others describe theoretical methods of aviation accident forecasting, as well as early warning and prevention (Duanmu, et al., 2013).

The ICAO (ICAO, 2013) states that the focus of the long-term objective is the implementation of predictive systems that will become integral part of the aviation systems in the future. Sustainable growth of the international aviation system will require the introduction of advanced safety capabilities that increase capacity while maintaining or enhancing operational safety margins and manage existing and emerging risks. The long-term objective is to support an operational environment characterized by increased automation and the integration of advanced capabilities on the ground and in the air. ICAO has committed to the development and implementation of new safety initiatives in response to concerning trends in safety data. The future aviation system will become increasing automated, far more complex and the role of aviation professionals may change. Safety oversight under these circumstances will require the use of proactive and predictive risk modelling capabilities. This approach will allow the aviation community to effectively monitor the health of the aviation system, virtually in real-time, and make necessary adjustments to maintain the desired levels of safety. ICAO (ICAO, 2013) has begun to put in place significantly improved and expanded online access to real-time safety information through its iSTARS (Integrated Safety Trend Analysis and Reporting System) initiative, as well as a range of additional aviation data, to support the implementation of the evolving approach to safety management. A series of goals support this aspirational safety goal. The ICAO 2020-2022 edition of the GASP (ICAO, 2019) calls the States to implement effective safety oversight systems, implement SSPs and move towards predictive risk management.

As stated in Airbus Safety Magazine (Airbus, 2014), recorders technology has improved significantly – from analogue to digital on tape, then to solid state able to record over 3,000 parameters. In the meantime, Flight Data Monitoring processes were encouraged and sometime requested by authorities. Today, while Flight Data Recorders (FDR) or Digital Flight Data Recorders (DFDR) are dedicated to accident investigation, Flight Data Analysis programs (Figure 22) extract data from easily accessible recorders and customize the recorded parameters. FDR logically led to FDA and the reactive process evolved into a predictive process. Analysts manually filter the data. They look for all high deviation magnitude events in order to assess any serious safety concern and take appropriate corrective action. Correlation with all other means like mandatory or voluntary reports for example, will multiply the analysis efficiency. All reliable events are stored into the database and are investigated on a regular basis to highlight any trend that could show a latent or potential risk.



**Figure 22 Example of Airbus Flight Data Analysis Suite**

Source: (NavBlue, 2020)

In 2015, Di Gravio and others stated that defining means to assess safety performance and delve into their causes is one of the current and future challenges of the air transport sector. The research aim was a statistical model of safety events in order to predict safety performance, combining in a Monte Carlo simulation the results emerged from the literature analysis with the analytical models of historic data interpretation. Authors concluded that through the analysis of the possible scenarios, assessing their impact on equipment, procedures and human factor, proposed model can address the interventions of the decision maker (Di Gravio, et al., 2015).

Roelen and others (Roelen, et al., 2016) conducted a study on an integrated approach to risk modelling in which the total aviation system, and human factors and cultural aspects are considered in connection with technical and procedural aspects and with emphasis on representation of emerging and future risks. Specific objectives were to: represent safety of the current total aviation system in accident scenarios; represent emerging and future risks in accident scenarios; represent safety culture and safety management in accident scenarios; and explain how to quantify the accident scenarios.

Khoshkhoo (Khoshkhoo, 2017) developed Dispatch Operations Safety Audit (DOSA) – a proactive and predictive method in safety management system that detects the capabilities and pitfalls of dispatcher performance. Potential applications of this research include the better threat and error management in Operations Control Centre (OCC) as well as identification of types of threats and errors.

International Transport Forum (ITF, 2018) points out that growing complexity in the transportation system has enabled the industry to carry an ever-increasing number of

passengers and volumes of freight at an ever-decreasing real cost. Growing complexity has also introduced new hazards to the transportation system and thus requires proper predictive risk analysis and mitigation that should be done as part of an SMS.

AFCAC (AFCAC, 2019) suggests the implementation of predictive safety systems. Emphasis is made on the fact that safety systems integration is possible through use of appropriate modular software suite which should encompass all of the major safety oversight responsibilities and typical automated systems that are already in use by a considerable number of regulators across the world. The software architecture focus areas should include legislation; organisation; SSP and SMS; personnel licensing (examinations and licensing); flight operations; aircraft incidents/accidents; airworthiness; aerodromes; air navigation services. Safety records and data should be maintained in a single, fully cross-referenced database (for each regulator) and it should allow detailed analysis of the safety risks as they apply to discrete areas of oversight and also across the whole aviation industry. Safety data and safety information management which addresses the necessary functions should ensure that the organisation's safety data and safety information is collected, stored, analysed, retained, and archived, as well as governed, protected, and shared.

Based on the highest density domain analysis, Ben and others proposed a new algorithm to perform prediction of the aviation safety in an uncertain framework. In order to perform the prediction of the aviation safety, highest density domain (HDR) is combined with uncertainty description technique to obtain the aviation safety interval and the corresponding interval probability level in the proposed method (Ben, et al., 2019).

Insua and others stated how, in most cases, the organisations use unsophisticated methods based on risk matrices for the development of aviation safety management systems. Authors presented models to forecast and assess the consequences of aviation safety occurrences as part of a framework for aviation safety risk management at state level (Insua, et al., 2019).

Zheqi and others, carried out forecasting of aviation safety probability based on the uncertainty of neural network point forecasting value. The uncertainty of aviation safety forecasting is described by three ideas: the numerical statistical characteristics of point forecasting value, the probability density fitting of point forecasting value and the distribution of error (Zheqi, et al., 2020).

This paragraph outlines application of predictive methods in other industry branches. For example, Attwood and others developed a model to predict the frequency and associated costs of occupational accidents in the offshore oil and gas industry (Attwood, et al., 2006). Munteanu & Aldemir illustrated simple pressurizer model, with the potential use of the dynamic system doctor approach and integrated safety assessment (DSD-ISA) methodology for on-line probabilistic accident management (Munteanu & Aldemir, 2003). Rathnayaka and others presented System Hazard Identification, Prediction and Prevention (SHIPP) methodology to identify, evaluate, model the accident process, predict and prevent future accidents, with case study carried out on a liquefied natural gas (LNG) facility (Rathnayaka, et al., 2011). Peters and others explain how predictions from a causal model will in general work as well under interventions as for observational data, but in contrast, predictions from a non-causal model can



potentially be very wrong. Authors proposed to exploit invariance of a prediction under a causal model for causal inference using invariant prediction (Peters, et al., 2016). In 2019, Xuecai and others suggested an application of new method of risk prediction and factorial risk analysis for coal and gas outburst accidents, based on IFOA-GRNN and Apriori algorithms (Xuecai, et al., 2019).

### 4.3 Types of analytical methods

Analytical methods include methods for estimating parameters, testing of statistical hypotheses, comparing the average performance of two groups on the same measure to identify differences or similarities, and identifying possible correlations and relationships among variables (Bugayko, et al., 2019) (Kurt & Gereede, 2018) (Hastie, et al., 2009).

Statistical data on number of flights will be used in the following chapters, to serve as dataset for all examples of descriptive and statistical analysis, using various analytical methods. Table 7 shows statistical data on indicator named „Number of flights” at Franjo Tuđman Airport in Zagreb, for period from December 2017 to February 2022.

**Table 7 Statistical data on number of flights at Franjo Tuđman Airport for period from December 2017 to February 2022**

Month/ Year	Number of flights	Month/ Year	Number of flights	Month/ Year	Number of flights
Dec-17	2912	Jun-19	4088	Dec-20	1392
Jan-18	3039	Jul-19	4356	Jan-21	1403
Feb-18	2692	Aug-19	4401	Feb-21	1249
Mar-18	3143	Sep-19	4190	Mar-21	1648
Apr-18	3384	Oct-19	4045	Apr-21	1840
May-18	4023	Nov-19	3344	May-21	2092
Jun-18	4124	Dec-19	3351	Jun-21	2426
Jul-18	4461	Jan-20	3133	Jul-21	2931
Aug-18	4393	Feb-20	2994	Aug-21	3086
Sep-18	4176	Mar-20	2310	Sep-21	3401
Oct-18	3970	Apr-20	365	Oct-21	3394
Nov-18	3223	May-20	572	Nov-21	2917
Dec-18	3060	Jun-20	1138	Dec-21	3218
Jan-19	3045	Jul-20	2037	Jan-22	2776
Feb-19	2826	Aug-20	2246	Feb-22	2637
Mar-19	3356	Sep-20	1995		
Apr-19	3776	Oct-20	1772		
May-19	4283	Nov-20	1556		

Source: Author according to (Franjo Tuđman Airport, 2022)

Following sub-chapters explain and provide examples of some analytical methods. Review of most common analytical tools are outlined and explained including descriptive statistics, histograms of frequencies, stem-and-leaf plots, Q-Q plots, box plots, and tests of normality.

### 4.3.1 Descriptive statistics

Descriptive statistics deals with organising collected data and presenting statistical summary using numerical and graphical tools (tables, figures, graphs). Table 8 shows example of descriptive statistics.

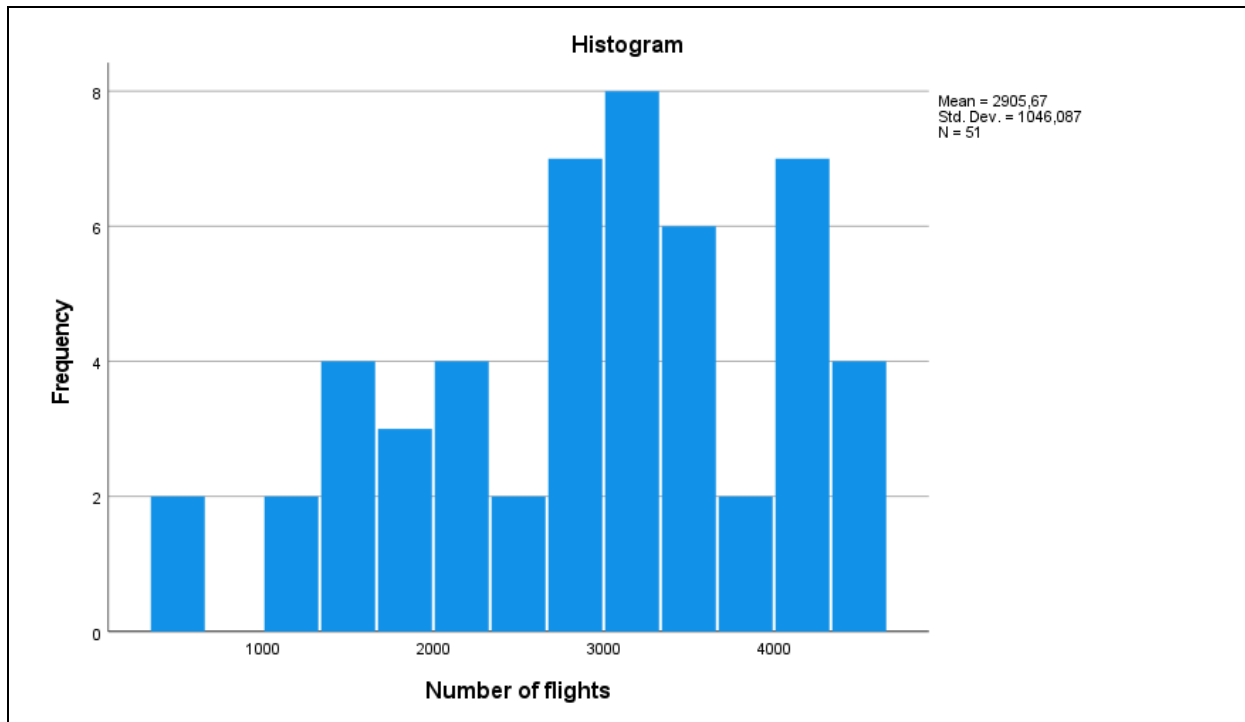
**Table 8 Example of descriptive statistics**

		<b>Descriptives</b>		
		Statistic	Std. Error	
Number of flights	Mean	2905.67	146.481	
	95% Confidence Interval for			
	Mean	Lower Bound	2611.45	
		Upper Bound	3199.88	
	5% Trimmed Mean		2948.76	
	Median		3045.00	
	Variance		1094297.987	
	Std. Deviation		1046.087	
	Minimum		365	
	Maximum		4461	
	Range		4096	
	Interquartile Range		1684	
	Skewness		-0.484	0.333
	Kurtosis		-0.393	0.656

*Source: Author using IBM SPSS Statistics*

### 4.3.2 Frequency histogram

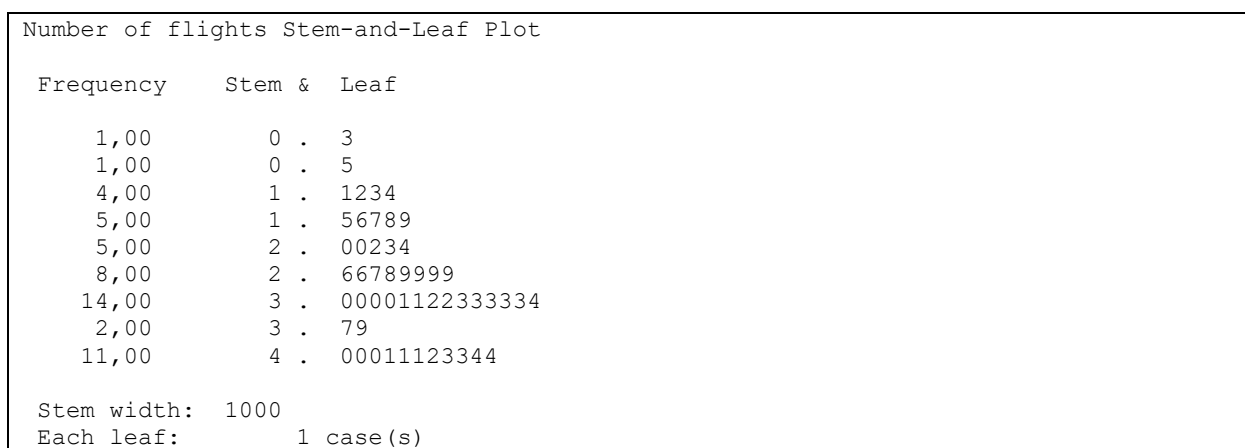
The histogram of frequencies (frequency histogram) or relative frequencies of the categories of the selected variable consists of columns associated with the category whose height corresponds to the frequency or relative frequency of the category. A histogram is used to display numerical data. Before creating a histogram, it is necessary to group the data into intervals and create a frequency table of the grouped data. The histogram is drawn in the coordinate system so that the columns are placed over the corresponding intervals. The height of the column corresponds to the frequency of the interval. Figure 23 shows example of frequency histogram.



**Figure 23 Example of frequency histogram**  
 Source: Author using IBM SPSS Statistics

### 4.3.3 Stem-and-leaf plots

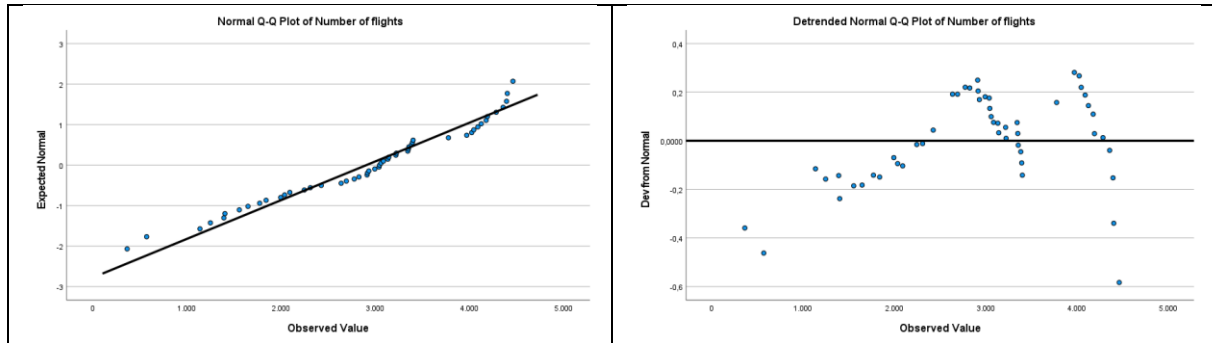
In a Stem-and-leaf plot, the Stem represents a common group of data, and the Leaf is variable group of data. Stem-and-leaf plot is a special table where each data value is split into a „stem“ (the first digit or digits) and a „leaf“ (usually the last digit). Figure 24 shows example of Stem-and-leaf plot



**Figure 24 Example of stem-and-leaf plot**  
 Source: Author using IBM SPSS Statistics

#### 4.3.4 Q-Q plots

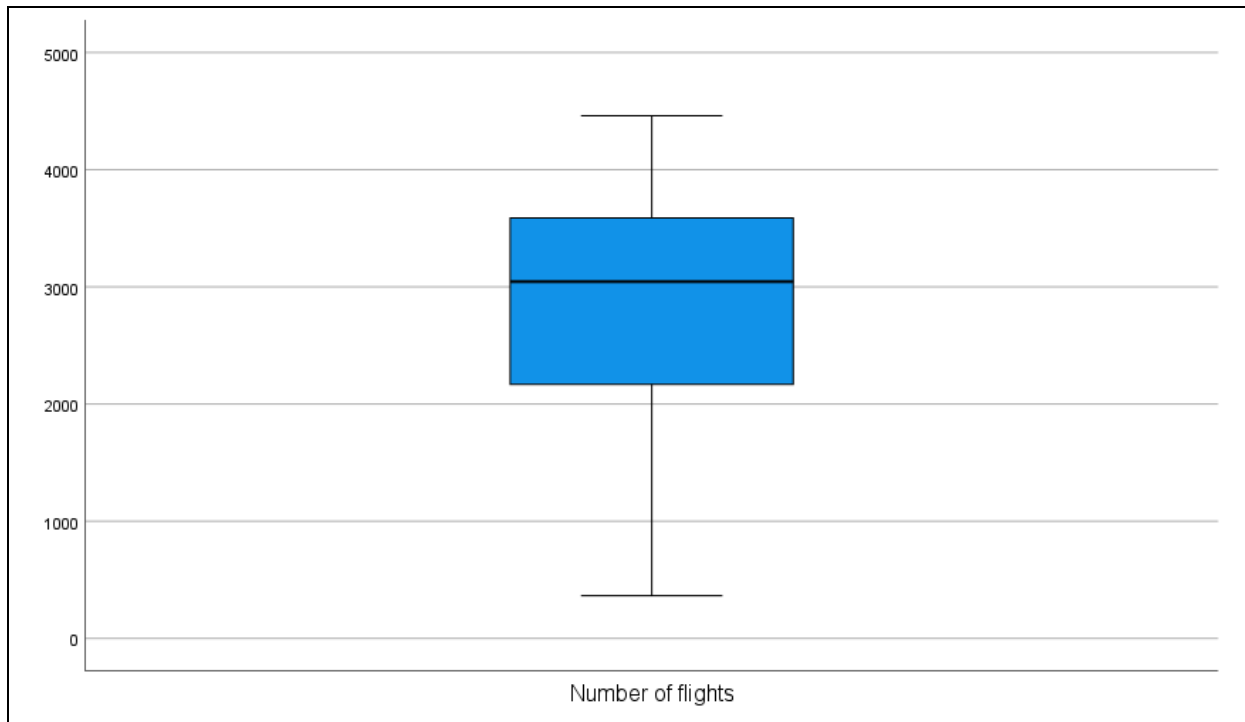
QQ-plot (quantile-quantile plot) is one of the best ways to compare distributions of the sample  $x$  with theoretical distribution. In this way, it is possible to determine the distribution of the sample, and later confirm it with a statistical test. Figure 25 shows examples of Q-Q plot.



**Figure 25 Examples of Q-Q plots**  
*Source: Author using IBM SPSS Statistics*

#### 4.3.5 Box plots

A box plot (box and whisker plot) is a simple graph that shows the characteristic “five”. A box plot consists of a rectangle that shows the data from the lower to the upper quartile. The line across the rectangle indicates the median. The lower and upper horizontal lines are called whiskers. They can be defined differently, but most often they represent the smallest and largest data that is within 1.5 times the interquartile range, looking from the lower or upper quartile. All points outside this limit are drawn separately and are considered outliers (values that deviate from the others). The appearance of the box plot indicates the degree of dispersion and asymmetry (skewness) and can show outliers among the data. Figure 26 shows example of box plot.



**Figure 26 Example of box plot**  
 Source: Author using IBM SPSS Statistics

#### 4.3.6 Tests of normality

A normality test is used to determine whether sample data has been drawn away from the Normal (Gauss) Distribution. Most common tests of normality include Anderson-Darling test, Cramér-Von Mises criterion, D'Agostino's K-squared test, Kolmogorov-Smirnov test, Lilliefors test, Normal probability plot, Shapiro-Wilk test, and Shapiro-Francia test. Table 9 shows examples of Kolmogorov-Smirnov, Shapiro-Wilk and Lilliefors test of normality.

**Table 9 Examples of tests of normality**

	Tests of normality					
	Kolmogorov-Smirnov <sup>a</sup>			Shapiro-Wilk		
	Statistic	df	Sig.	Statistic	df	Sig.
Number of flights	0.110	51	0.170	0.956	51	0.056

a. Lilliefors Significance Correction

Source: Author using IBM SPSS Statistics

#### 4.4 Types of predictive methods

This chapter describes, explains, and provides examples of predictive (forecasting) methods (Brockwell & Davis, 2016) (Eastwell, 2012) (Eastwell, 2014) (Lawson, 2008) (Maeng & Bell,

2013) (Wiedermann & Von Eye, 2016). Review of most common predictive methods are outlined and explained including trend projection, exponential smoothing, moving average, ARIMA modelling, etc. This chapter also covers forecasting (predicting) methods used in segment of civil aviation, with special emphasis on forecasting methods used in air navigation services, airport operations and airline operations. An overview of predictive methods used in overall aviation industry is provided, as well. Based on the analysis of reviewed methods, the selection is made for most suitable predictive methods that can be applied in the segment of aviation safety management.

#### 4.4.1 Forecasting in aviation

Forecasts are predictions of future activities supported by precise estimates, analysis of historical trends in transport demand, projected economic growth and other relevant factors that may affect the growth of air traffic in the market. The forecast considers short-term, mid-term or long-term period of time. Output data, level of detail, and forecasting methods may vary.

In the field of civil aviation, the forecast is used as:

- assistance to states in the orderly development of civil aviation, as well as assistance at all levels of governmental organisations in terms of airspace and airport infrastructure planning,
- assistance to airlines in planning equipment and route structure in the long run,
- assistance to aircraft manufacturers in planning future aircraft types (in terms of size and range) and determining the time for their development.

#### 4.4.2 Overview of forecasting methods

Types of forecasting methods include two main categories: methods of time series analysis and econometric analysis.

Methods of time series analysis include the following:

- Trend projection,
- Time series decomposition methods:
  - Simple exponential smoothing,
  - Exponential smoothing method with trend and seasonality,
  - Moving average method,
  - Auto regression model that integrates moving average (ARIMA).

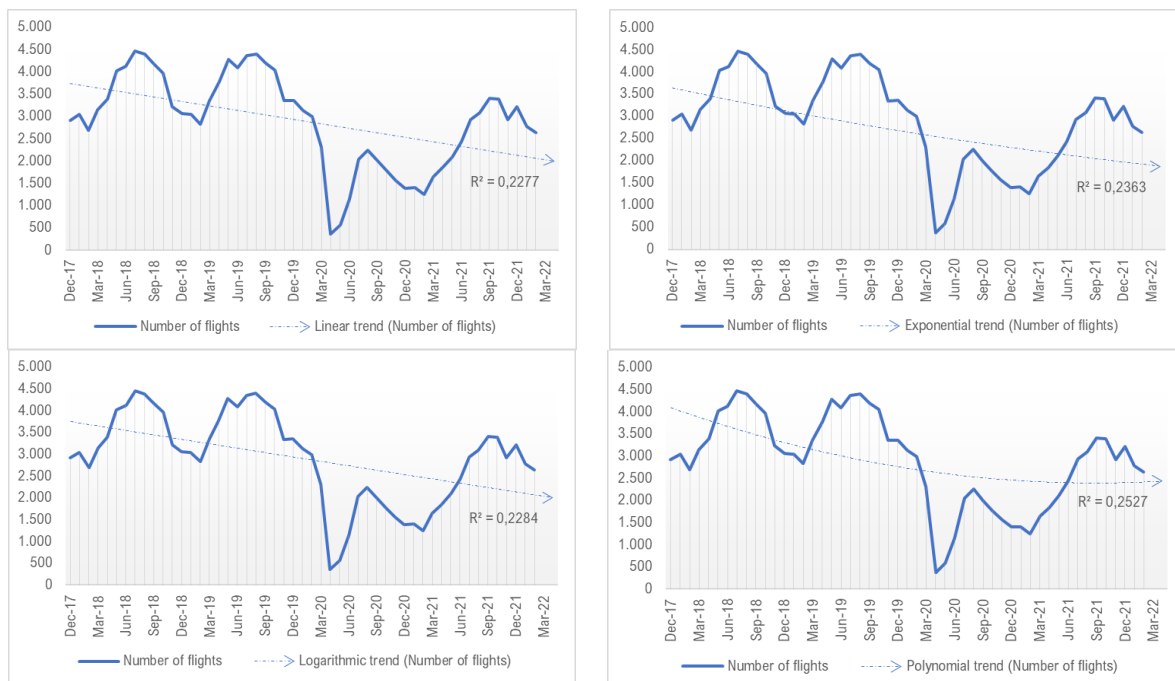
Methods of time series analysis are based on assumptions of historical data that tend to continue and they rely on available historical data. They are used in an environment that reflects the stability of the input parameters that are evaluated in the short-term forecast period. Time series decomposition methods distinguish the problem using different components. They are

particularly relevant when there is a large seasonal or cyclical component in historical data. These methods are used to identify three underlying components: trend, seasonal component and cyclical component if any.

Statistical data on number of flights at Franjo Tuđman Airport in Zagreb, for period from December 2017 to February 2022 (as per Table 7), will be used in the following sub-chapters, to serve as dataset for all examples of forecasting, using various forecasting (predictive) methods.

#### 4.4.2.1 Trend projection

The first step in forecasting air traffic activities is to review historical data, i.e., time series, and determine their trends. In the context of mid-term or long-term forecasting, the trend represents the evolution of traffic over a long period of time, excluding traffic oscillations for short-term forecasts. The different forms of trend curves can be represented by the relationship of mathematical quantities, as shown in Figure 27. Trends are made for parameter „Number of flights” at Franjo Tuđman Airport in Zagreb, as per Table 7.



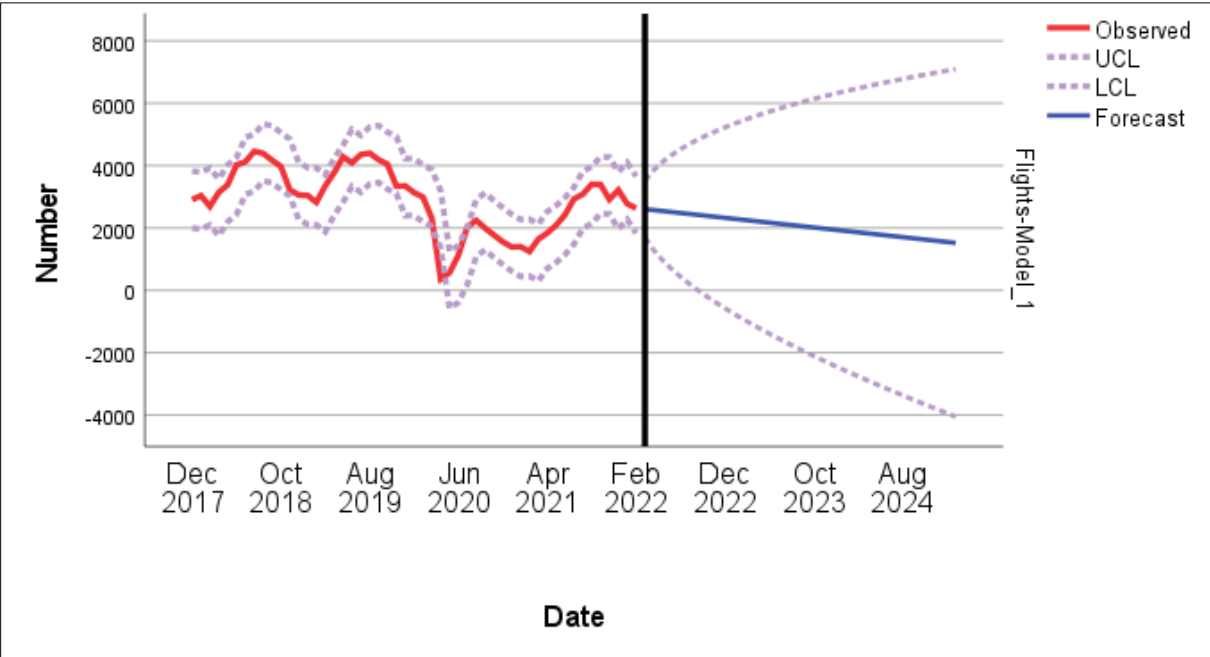
**Figure 27 Examples of trendline curves for number of flights**  
 Source: Author using Microsoft Excel according to (Franjo Tuđman Airport, 2022)

#### 4.4.2.2 Nonseasonal exponential smoothing

The most common smoothing technique is exponential smoothing. Exponential smoothing generally relies on the philosophy of decomposition. The method places more emphasis on the latest data, in order to increase its impact on the forecast. In doing so, it is important to identify the seasonal component in data, if monthly or quarterly forecasts are considered.

Nonseasonal exponential smoothing include Holt's linear trend, Brown's linear trend, damped trend, and simple exponential smoothing method.

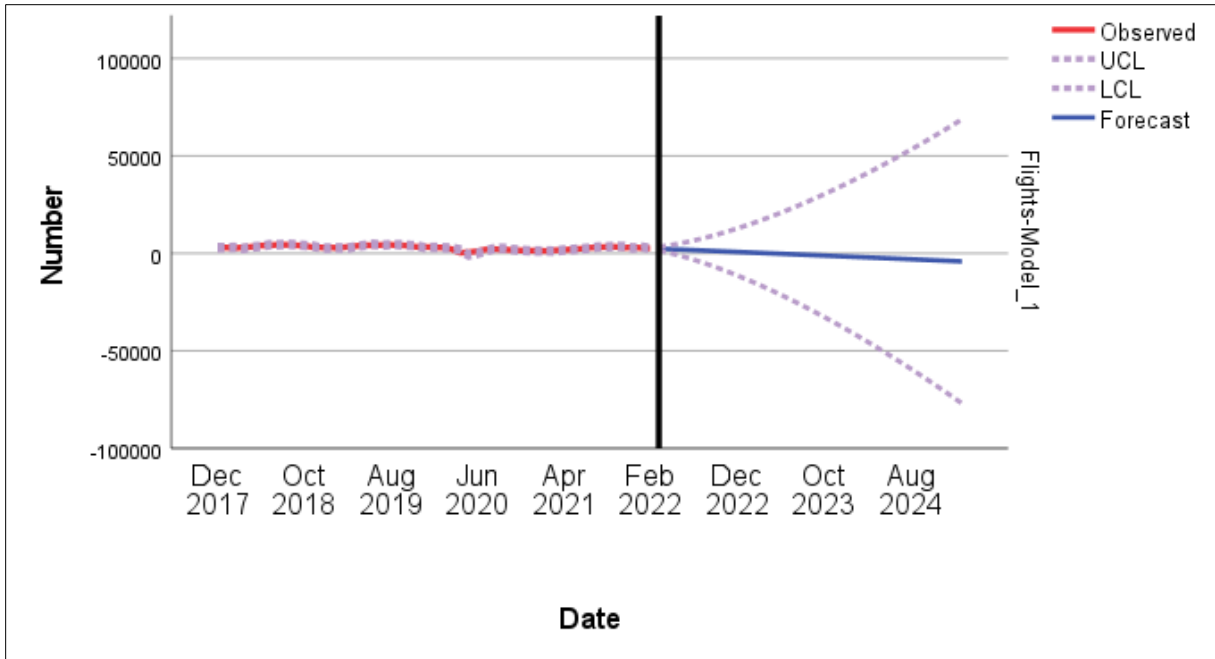
Holt's linear trend method is extended simple exponential smoothing that allows the forecasting of data with a trend. Figure 28 shows an example of forecasting number of flights using Holt's linear trend method.



**Figure 28 Example of forecasting number of flights using Holt's linear trend**  
*Source: Author using IBM SPSS Statistics according to (Franjo Tuđman Airport, 2022)*

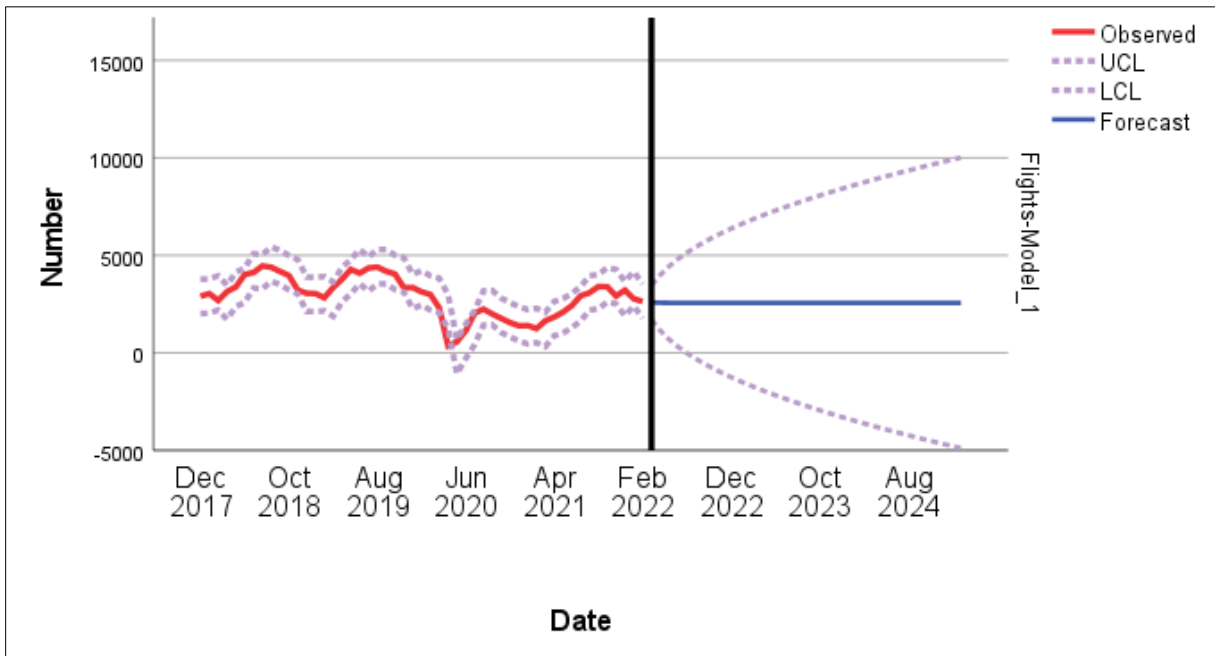
Brown's linear trend method is known as Brown's linear exponential smoothing, as one type of exponential smoothing which uses two different smoothed series that are centred at different points in time. Figure 29 shows an example of forecasting number of flights using Brown's linear trend method.





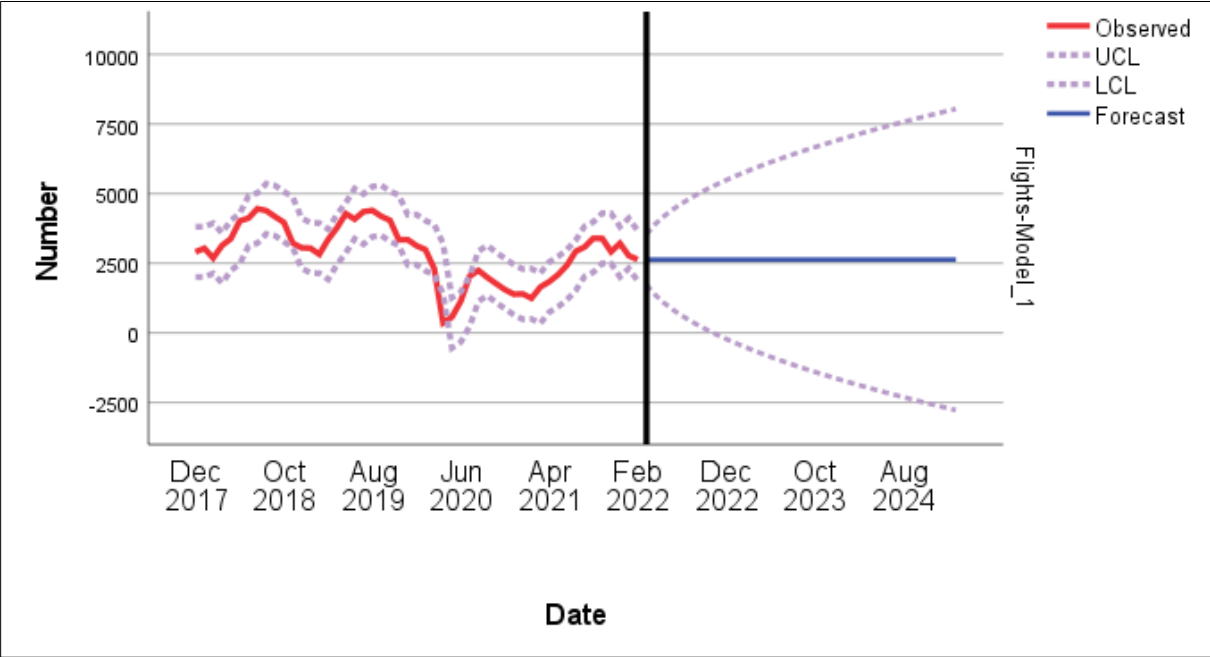
**Figure 29 Example of forecasting number of flights using Brown's linear trend**  
 Source: Author using IBM SPSS Statistics according to (Franjo Tuđman Airport, 2022)

Damped trend is Holt's linear trend method with parameter that that “dampens” the trend to a flat line sometime in the future. Figure 30 shown an example of forecasting number of flights using damped trend method.



**Figure 30 Example of forecasting number of flights using damped trend**  
 Source: Author using IBM SPSS Statistics according to (Franjo Tuđman Airport, 2022)

The simple exponential smoothing method tries to solve the causes of time series fluctuations (trend, seasonal and cyclical component). Figure 31 shows an example of forecasting number of flights using simple exponential smoothing method.

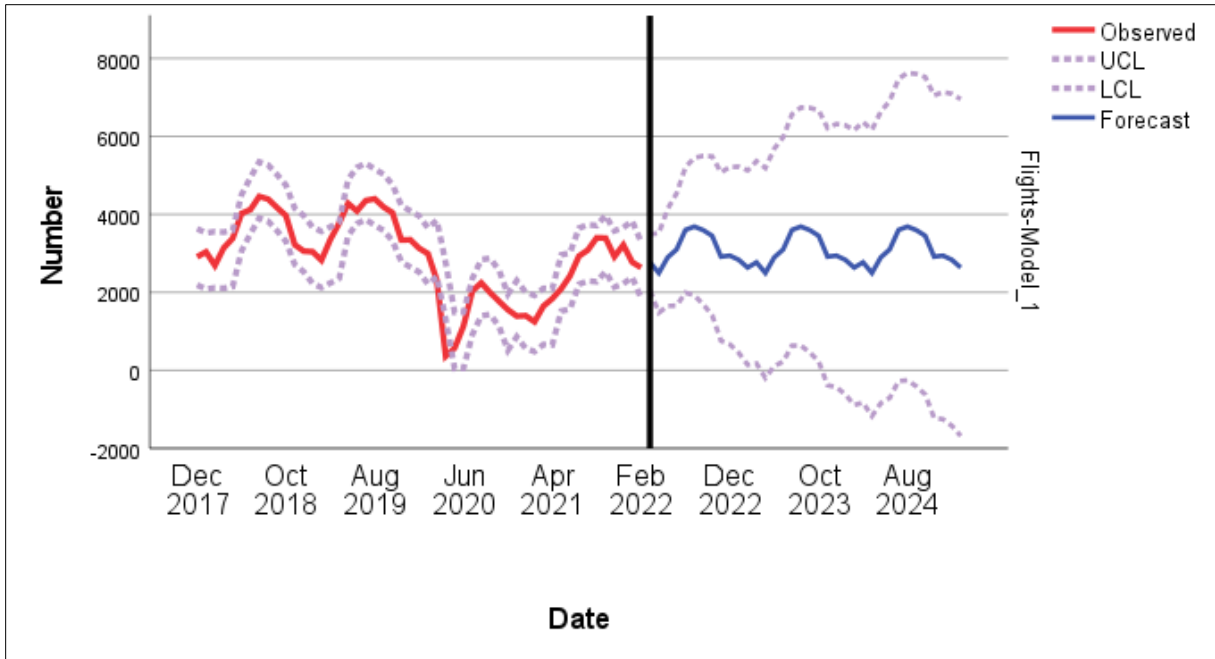


**Figure 31 Example of forecasting number of flights using simple exponential smoothing method**  
 Source: Author using IBM SPSS Statistics according to (Franjo Tuđman Airport, 2022)

4.4.2.3 Seasonal exponential smoothing

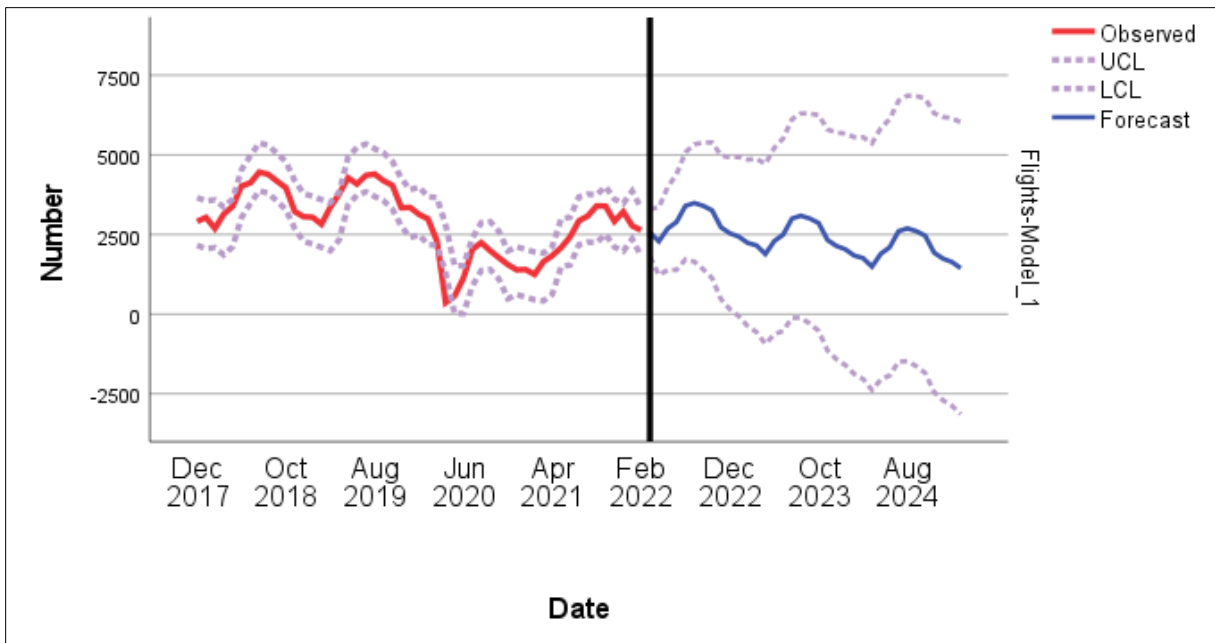
The aim of seasonal exponential smoothing is to capture the behaviour of time series by dividing it into a trend component, a seasonal component, and a forecast error component. Some of the seasonal exponential smoothing methods are simple seasonal exponential smoothing, Winter's additive and Winter's multiplicative method.

Simple seasonal exponential smoothing method for forecasting data with a systematic trend or seasonal component (Škurla Babić, 2011). It is forecasting method that may be used as an alternative to the popular Box-Jenkins ARIMA methods. Figure 32 shows examples of forecasting number of flights using simple seasonal exponential smoothing method.



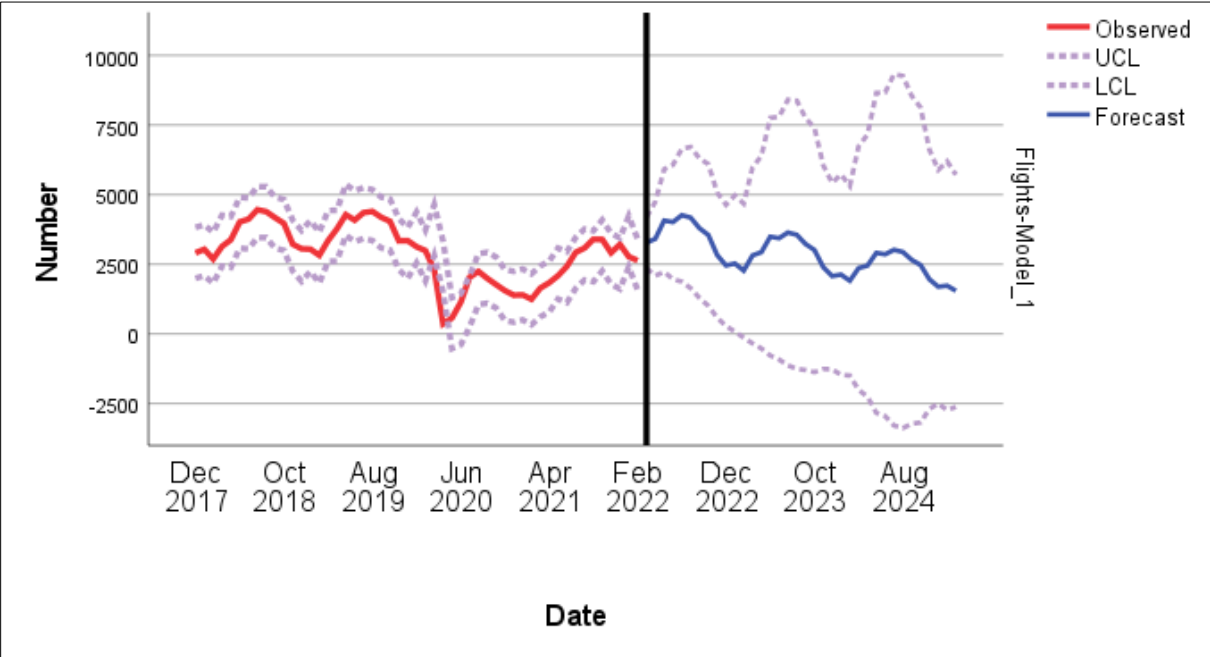
**Figure 32 Example of forecasting number of flights using simple seasonal exponential smoothing method**  
 Source: Author using IBM SPSS Statistics according to (Franjo Tuđman Airport, 2022)

Winter's (also called Holt-Winter's) additive method is an extension of Holt's method that captures seasonality. This method produces exponentially smoothed values for the level, trend and seasonal adjustment of the forecast. Figure 33 shows an example of forecasting number of flights using Winter's additive method.



**Figure 33 Example of forecasting number of flights using Winter's additive method**  
 Source: Author using IBM SPSS Statistics according to (Franjo Tuđman Airport, 2022)

Winter's (also called Holt-Winter's) multiplicative method also calculates exponentially smoothed values for level, trend, and seasonal adjustment of the forecast. This seasonal multiplicative method multiplies the trended forecast by the seasonality, producing the multiplicative forecast. Figure 34 shows an example of forecasting number of flights using Winter's multiplicative method.



**Figure 34 Example of forecasting number of flights using Winter's multiplicative method**  
 Source: Author using IBM SPSS Statistics according to (Franjo Tuđman Airport, 2022)

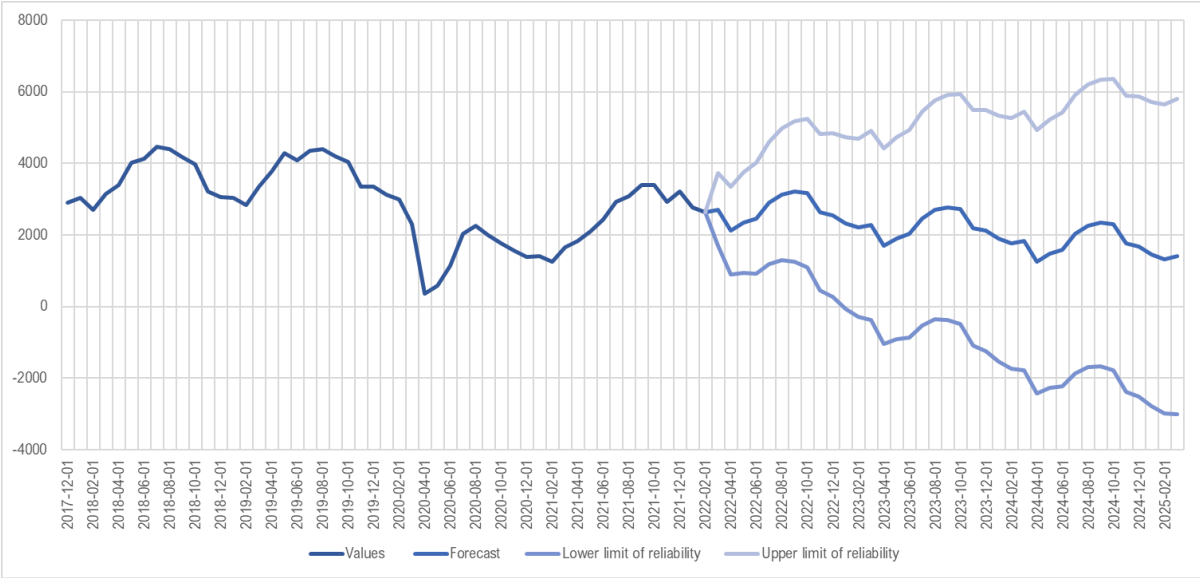
4.4.2.4 Moving average method

A simple moving average (SMA) is a calculation that takes the arithmetic mean of a given set of data over the specific number of days in the past. It is a calculation to analyse each data point by creating a series of averages of different subsets of the full data set.

The moving average method is similar to exponential smoothing, the only difference in terms is that each observation is equal to the weighted. Due to equal weights, moving averages tend to lag behind the current situation in relation to exponential smoothing. The advantage of moving averages over exponential smoothing is much simpler use of data. The disadvantage of moving averages is that it requires a longer set of data for analysis.

When making a forecast in the short term, moving average methods as well as exponential smoothing methods can be used.

Figure 35 shows example forecast of number of flights at Franjo Tuđman Airport in the period from March 2022 to February 2025, using Microsoft Excel Forecasting Tools and time series decomposition forecasting methods.



**Figure 35 Example of forecasting number of flights using moving average method**  
 Source: Author using Microsoft Excel according to (Franjo Tuđman Airport, 2022)

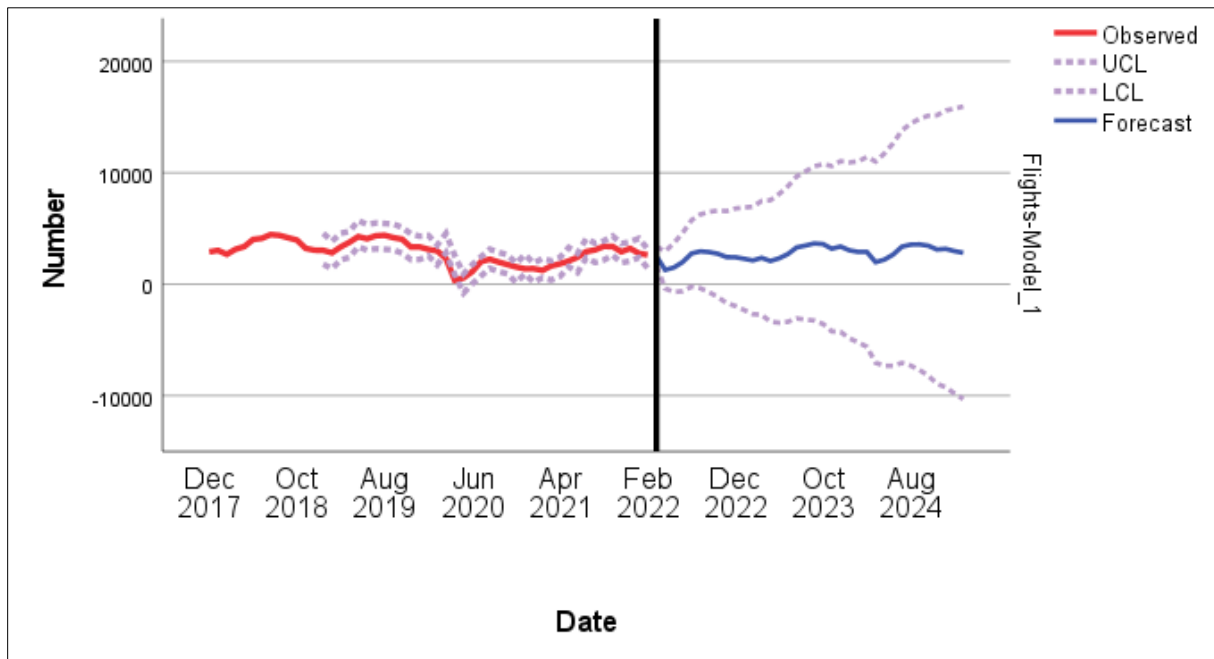
**4.4.2.5 Auto Regressive Integrated Moving Average (ARIMA)**

Each set of data can be utilised using the Auto Regressive Integrated Moving Average (ARIMA), known as the Box-Jenkins method, which is suitable for forecasting only in the short term. The method is suitable for processing complex data using time series in which there are different data patterns, such as trend, seasonal and cyclical component.

An autoregressive integrated moving average (ARIMA) model is fitting time series data either to better understand the data or to predict future points in the series. ARIMA models can be estimated following the Box-Jenkins approach (Otexts, 2022).

Non-seasonal ARIMA models are generally denoted  $ARIMA(p,d,q)$  where  $p$  is the order (number of time lags) of the autoregressive model,  $d$  is the degree of differencing (the number of times the data have had past values subtracted), and  $q$  is the order of the moving-average model (Otexts, 2022).

Seasonal ARIMA models are usually denoted  $ARIMA(p,d,q)(P,D,Q)m$ , where  $m$  refers to the number of periods in each season, and the uppercase  $P,D,Q$  refer to the autoregressive, differencing, and moving average terms for the seasonal part of the ARIMA model (Otexts, 2022). Figure 36 shows example of forecasting number of flights using ARIMA modelling and statistical data of Franjo Tuđman Airport (Franjo Tuđman Airport, 2022).



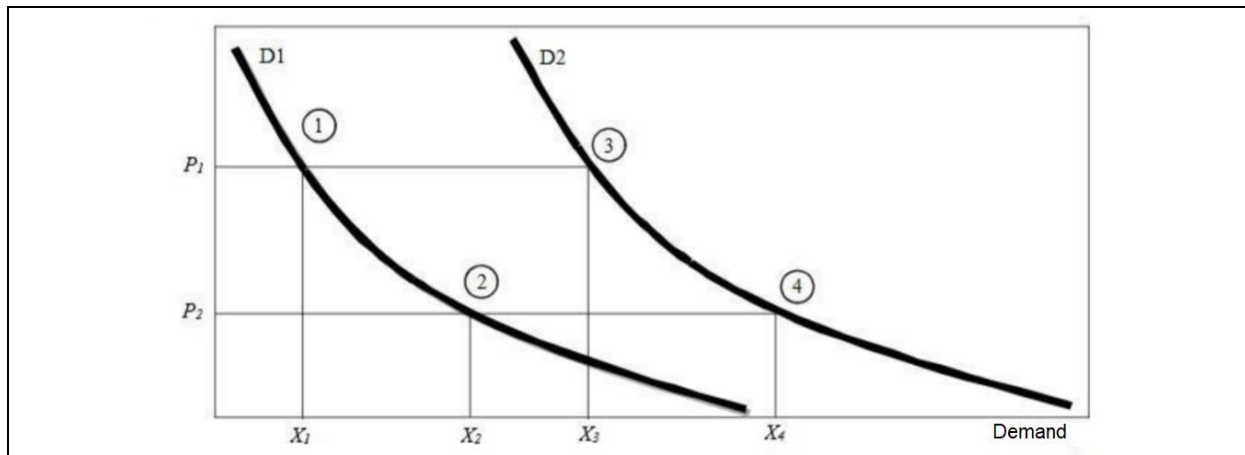
**Figure 36 Example of forecasting number of flights using ARIMA modelling**  
 Source: Author using IBM SPSS Statistics according to (Franjo Tuđman Airport, 2022)

#### 4.4.2.6 Econometric analysis

The main steps in making a forecast using the econometric model are:

- defining the problem,
- selection of relevant causal or independent variables,
- determining the availability of data or selecting alternative or represented variables,
- designing a model that determines the type of functional relationship between the dependent variable and the selected independent (causal) variables,
- conducting an analysis, in order to test the assumed relationship, including the estimation of model coefficients, their sizes and labels, and statistical measurement,
- when the above criteria are met, it is necessary to determine the model in its final form,
- development of forecasts of the future scenario for independent variables from which the traffic forecast is later derived.

The use of multiple regression analysis that includes the structure of prices and revenues is called econometric analysis. The starting point for econometric analysis is a regression equation model that sets the causal relationship between a dependent variable and one or more independent variables. The econometric model attempts to explain the traffic demand caused by changes in independent variables. Figure 37 shows an example of forecasting using econometric analysis of traffic demand.



**Figure 37 Example of forecasting using econometric analysis of traffic demand**  
*Source: (Greene, 2003)*

#### 4.4.3 Forecasting methods in air navigation services

The European Organisation for the Safety of Air Navigation (EUROCONTROL) uses quantitative methods for air traffic forecasting in Europe over a period of time.

Statistics and forecasts are necessary for EUROCONTROL, its members and air transport stakeholders because:

- statistics allow measuring and understanding what is happening in the air transport industry,
- quantitative forecasts allow planning responses for future air traffic demand (EUROCONTROL, 2021).

When forecasting, highly automated and structured processes are used, but due to various factors, different forecasting methods are used, such as:

- time series methods for extrapolating historical data samples,
- econometric analyses that consider how economic, social and operational conditions affect the development of transport,
- scenario-based inputs that describe future developments in Europe over the next ten years,
- specific data-driven models; these methods rely on historical data or on tracking the latest trends.

The Network Manager (NM) provides traffic and delay forecasts, which it later analyses to support the European Aviation Network's global performance in line with the European Commission's Implementing Rules in order to:

- continuously evaluate the operation of network functions and monitor network processes, analyse, and report on all aspects of network operational effects,

- recommend measures and/or take the necessary actions to ensure network performance (Steiner, et al., 2014),
- compare the effects with the objectives set out in the Network Strategy Plan (NSP), the Network Operational Plan (NOP) and the Network Performance Plan (NPP) which identify shortcomings and proposes corrective actions.

This way, the NM ensures a consolidated and coordinated approach to all planned and operational activities of the network.

As part of EUROCONTROL (EUROCONTROL, 2021), the STATFOR office publishes air traffic forecasts in Europe, countries, or regions at the level of major traffic flows (e.g., transatlantic traffic flow). The purpose of traffic forecasting is to support the planning and monitoring of ATM systems that specialize in IFR aircraft movements, rather than the number of passengers or the amount of cargo. The statistics and forecasts services are discussed and reviewed by the STATFOR User Group (SUG). The main purpose of SUG is to cover methodological and practical aspects of statistics and forecasting, exchange of information and views on the current and future situation in air traffic as well as on activities in national administrations and international organisations.

The STATFOR forecasts has served the European ATM area since the 1970s and is the only air traffic forecast service covering Europe.

The Short-Term Forecast (STF) of traffic observes a period of two years in advance and is integrated into the mid-term forecast. It is published twice a year, in February and September. Example of forecast is IFR aircraft movement forecast.

Mid-Term Forecast (MTF) of traffic observes a time period of seven years and is based on a short-term forecast (STF). The mid-term forecast combines IFR aircraft statistics with economic growth and models of important factors in the air transport industry such as: costs, airport capacity, passengers, occupancy factors, aircraft size, etc. The MTF provides a comprehensive picture of the expected development of air transport in Europe using high and low growth scenarios. The mid-term forecast is also published twice a year, in February and September.

The Long-Term Forecast (LTF) considers a number of scenarios for the air transport industry in the next 20 years. It raises a number of „what if” issues to be explored within the air transport industry (e.g., the growth of small business aircraft or direct flights) or beyond (e.g., oil prices or environmental constraints). The long-term forecast model and its sub-models are used to make forecasts between small pairs of airports, passenger, cargo and military flights, and business aviation flights that are eventually merged into a final forecast.

The input data used in the preparation of the initial annual forecast are:

- economic growth forecast (GDP),
- recent trends in annual traffic,
- historical data on the number of flights for different types of flights between airports,
- past and future trends, percentage adjustment of movements between traffic zones,
- network of aircraft, distances, and changes in travel time,



- market share of low-cost airlines, by adding an additional IFR number of aircraft movements,
- demography, which has little impact on the short-term and mid-term period, data from the UN population forecast,
- emissions of harmful gases,
- the size of the aircraft, expressed through the number of seats, which is used when converting the number of flights into the number of seats,
- occupancy factors, which are used when converting the number of seats into the number of passengers.

Example of forecast in ATM is shown in Figure 38 below. Figure shows EUROCONTROL’s mid-term forecast (seven-year forecast) of total en-route service units, from 2021 to 2027.



**Figure 38 EUROCONTROL Seven-Year Forecast 2021-2027**

Source: (EUROCONTROL, 2021)

#### 4.4.4 Forecasting methods in airport operations

Forecasts are predictions of future activities that may affect the growth of air traffic in the market. The better the predictive analysis, the more reliable the prediction, especially for a shorter period. Mid-term and long-term forecasts serve as a guide for airport planners to know at what point additional infrastructure needs to be installed at the airport. Traffic forecasts are first made on an annual basis.

Peak load forecasts are also made, which are usually based on a certain peak hour of the month, usually the thirtieth of the month, and which are used to plan and dimension the manoeuvring area, parking lots, passenger building, etc.

Exponential smoothing methods, thanks to their simplicity, robustness, and precision, belong to the most widespread methods of forecasting demand in airport capacity management systems. The exponential smoothing method with trend and seasonality (Holt-Winter method) is suitable if the data set contains a seasonal component in addition to the trend.

The set of airport forecasting methods includes time series analysis methods based on the assumption that historical patterns will continue and depend significantly on the availability of historical data:

- Projection trend – the first step in air traffic forecasting is to monitor historical data (time series) and determine the trend in traffic development,
- The decomposition method involves dissecting the problem into different components. These methods are especially relevant when there are strong seasonal or circular patterns in historical data.

#### 4.4.4.1 Example of making a forecast using the trend projection

In this part, the example of forecasting using trend projection is shown. Table 10 shows statistical data of Franjo Tuđman Airport in Zagreb, for period 2017-2022. Statistical data is available for indicators such as „Number of passengers” and „Tonnes of cargo”.

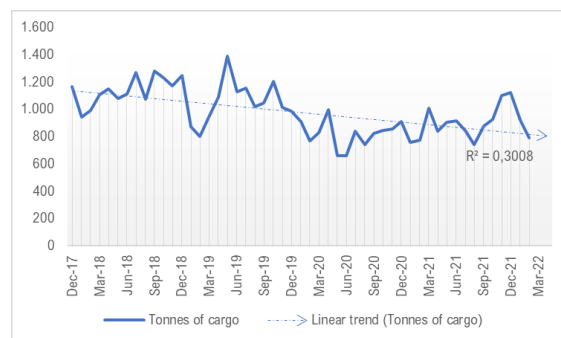
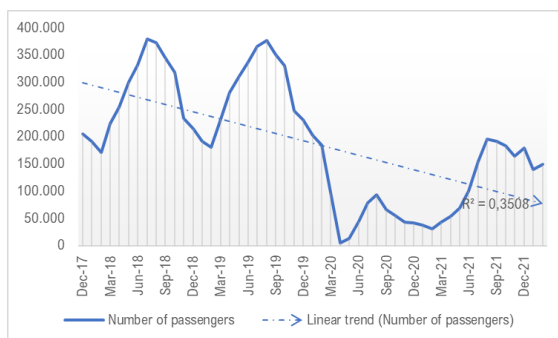
**Table 10 Statistical data of Franjo Tuđman Airport for period 2017-2022**

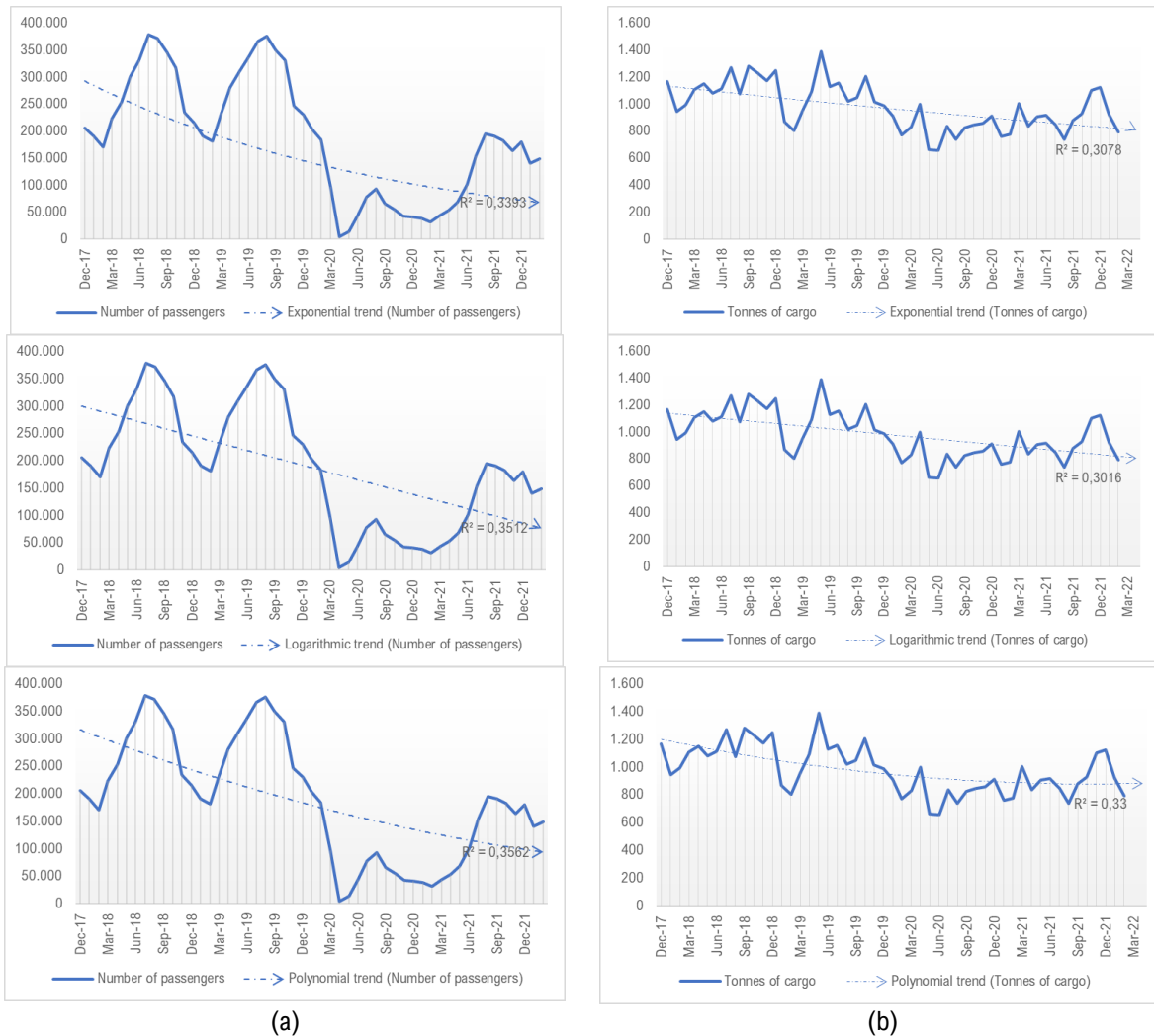
Month/ Year	Number of passengers	Tonnes of cargo
pro-17	205.682	1.169
sij-18	191.276	946
vlj-18	170.658	993
ožu-18	223.642	1.109
tra-18	253.843	1.150
svi-18	300.676	1.081
lip-18	331.533	1.111
srp-18	379.308	1.272
kol-18	372.590	1.077
ruj-18	345.770	1.281
lis-18	318.074	1.234
stu-18	234.075	1.171
pro-18	214.865	1.250
sij-19	191.197	871
vlj-19	181.154	805
ožu-19	232.978	957
tra-19	280.790	1.091
svi-19	311.368	1.389
lip-19	336.618	1.129
srp-19	366.242	1.159
kol-19	376.026	1.022
ruj-19	350.138	1.050
lis-19	330.598	1.205
stu-19	247.277	1.017
pro-19	231.145	989
sij-20	203.035	910
vlj-20	184.236	772
ožu-20	97.063	829
tra-20	5.118	999

svi-20	13.881	661
lip-20	44.402	659
srp-20	78.070	839
kol-20	93.553	740
ruj-20	65.963	823
lis-20	55.289	847
stu-20	42.715	856
pro-20	41.498	913
sij-21	38.063	761
vlj-21	31.534	776
ožu-21	43.731	1.007
tra-21	54.092	839
svi-21	69.019	908
lip-21	100.933	919
srp-21	154.323	848
kol-21	194.993	740
ruj-21	191.092	880
lis-21	182.838	926
stu-21	164.278	1.104
pro-21	179.582	1.126
sij-22	140.176	921
vlj-22	148.830	791

Source: Author according to (Franjo Tuđman Airport, 2022)

Figure 39 shows trend projections of passenger traffic and cargo traffic (b) at Franjo Tuđman Airport. Column on the left (a) in the Figure shows four forms of trend curves of indicator „Number of passengers”, i.e., linear, exponential, logarithmic, and polynomial. Due to R-squared criterion, the best fit is recorded for polynomial and linear trend. Column on the right (b) in the Figure shows four forms of trend curves of indicator „Tonnes of cargo”, i.e., linear, exponential, logarithmic, and polynomial. Due to R-squared criterion, the best fit is recorded for polynomial and exponential trend.





**Figure 39 Trend projections of passenger traffic (a) and cargo traffic (b) at Franjo Tuđman Airport**  
 Source: Author according to (Franjo Tuđman Airport, 2022)

#### 4.4.4.2 Example of forecasting using the decomposition method

In this part, the example of forecasting using decomposition methods (exponential smoothing, seasonal component) is shown. Table 11 shows forecasted values of indicators: „Number of passengers” and „Tonnes of cargo”, based on statistical data of Franjo Tuđman Airport in Zagreb (Table 10), for period 2022-2025.

**Table 11 Forecasts of indicators at Franjo Tuđman Airport for period 2022-2025**

Timeline	Values	Forecast	Lower limit of reliability	Upper limit of reliability	Values	Forecast	Lower limit of reliability	Upper limit of reliability

---

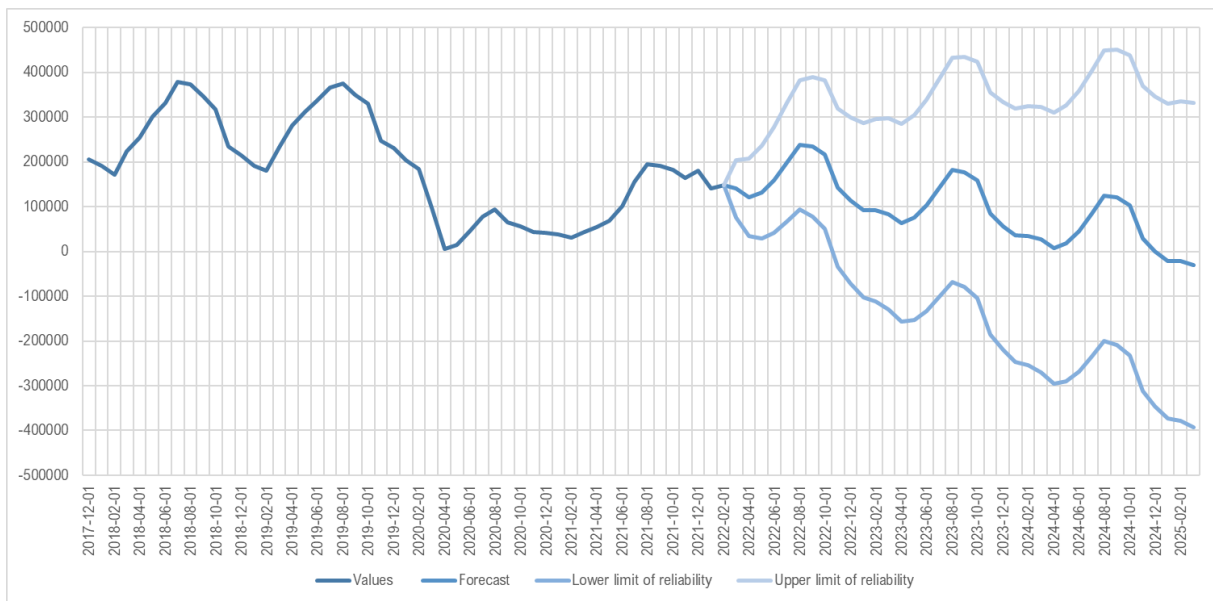
Dec-17	205682	1169
Jan-18	191276	946
Feb-18	170658	993
Mar-18	223642	1109
Apr-18	253843	1150
May-18	300676	1081
Jun-18	331533	1111
Jul-18	379308	1272
Aug-18	372590	1077
Sep-18	345770	1281
Oct-18	318074	1234
Nov-18	234075	1171
Dec-18	214865	1250
Jan-19	191197	871
Feb-19	181154	805
Mar-19	232978	957
Apr-19	280790	1091
May-19	311368	1389
Jun-19	336618	1129
Jul-19	366242	1159
Aug-19	376026	1022
Sep-19	350138	1050
Oct-19	330598	1205
Nov-19	247277	1017
Dec-19	231145	989
Jan-20	203035	910
Feb-20	184236	772
Mar-20	97063	829
Apr-20	5118	999
May-20	13881	661
Jun-20	44402	659
Jul-20	78070	839
Aug-20	93553	740
Sep-20	65963	823
Oct-20	55289	847
Nov-20	42715	856
Dec-20	41498	913
Jan-21	38063	761
Feb-21	31534	776
Mar-21	43731	1007
Apr-21	54092	839
May-21	69019	908
Jun-21	100933	919
Jul-21	154323	848
Aug-21	194993	740
Sep-21	191092	880
Oct-21	182838	926

---

Nov-21	164278				1104			
Dec-21	179582				1126			
Jan-22	140176				921			
Feb-22	148830	148830	148830	148830	791	791	791	791
Mar-22		140598	76471	204724		779	531	1027
Apr-22		120742	34426	207059		938	689	1188
May-22		132123	28218	236029		869	617	1121
Jun-22		159681	40729	278632		791	538	1045
Jul-22		198825	66500	331150		911	655	1167
Aug-22		238723	94231	383215		819	561	1077
Sep-22		234168	78433	389903		934	674	1194
Oct-22		216220	49978	382462		991	728	1253
Nov-22		142408	-33737	318552		879	614	1143
Dec-22		113655	-71884	299194		912	646	1178
Jan-23		92629	-101870	287129		693	424	961
Feb-23		91984	-111099	295067		598	328	869
Mar-23		83752	-129429	296933		710	437	983
Apr-23		63897	-157178	284971		870	595	1145
May-23		75278	-153434	303990		801	523	1078
Jun-23		102835	-133284	338953		723	444	1002
Jul-23		141979	-101336	385295		842	561	1124
Aug-23		181877	-68443	432198		750	466	1034
Sep-23		177322	-79827	434471		865	579	1151
Oct-23		159374	-104442	423190		922	634	1210
Nov-23		85562	-184770	355894		810	519	1100
Dec-23		56809	-219899	333518		843	551	1136
Jan-24		35784	-247171	318738		624	329	919
Feb-24		35138	-253941	324217		530	232	827
Mar-24		26906	-269523	323335		641	342	941
Apr-24		7051	-295255	309356		801	499	1103
May-24		18432	-289651	326514		732	427	1036
Jun-24		45989	-267776	359754		654	347	961
Jul-24		85133	-234225	404492		774	465	1083
Aug-24		125031	-199836	449899		681	370	993
Sep-24		120476	-209820	450773		797	483	1110
Oct-24		102529	-233120	438177		853	537	1169
Nov-24		28716	-312212	369644		741	422	1060
Dec-24		-36	-346175	346102		775	454	1096
Jan-25		-21062	-372344	330220		555	232	879
Feb-25		-21707	-378070	334655		461	135	787
Mar-25		-29940	-392430	332550		573	244	901

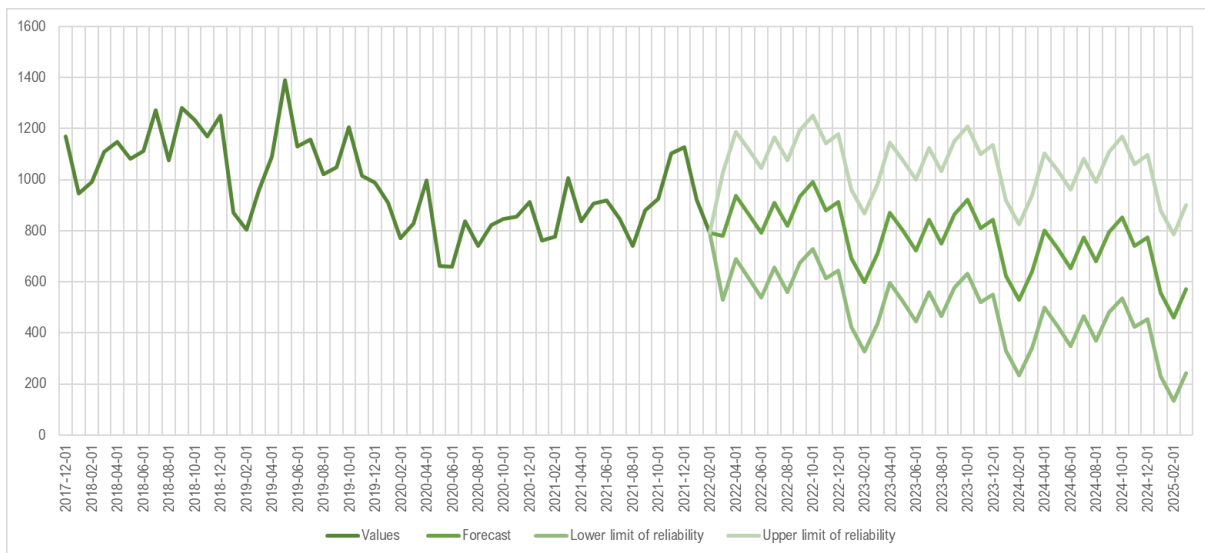
Source: Author using Microsoft Excel according to (Franjo Tuđman Airport, 2022)

Figure 40 shows example forecast of passenger traffic at Franjo Tuđman Airport in the period from March 2022 to February 2025, using Microsoft Excel Forecasting Tools and time series decomposition forecasting methods.



**Figure 40 Forecast of passenger traffic at Franjo Tuđman Airport**  
 Source: Author according to (Franjo Tuđman Airport, 2022)

Figure 41 shows example forecast of cargo traffic at Franjo Tuđman Airport in the period from March 2022 to February 2025, using Microsoft Excel Forecasting Tools and time series decomposition forecasting methods.



**Figure 41 Forecast of cargo traffic at Franjo Tuđman Airport**  
 Source: Author according to (Franjo Tuđman Airport, 2022)

#### 4.4.5 Unconstraining methods in airline operations

Accurate demand forecasting is essential with airline capacity management systems. By forecasting potential demand based on historical sales data and projected future events, airlines can predict: the size of targeted market segments and the price each segment will be willing to pay for a product or service. If the airline has data on demand on certain routes in the previous period, then it is possible to estimate the demand for future flights, considering the market situation, the economic situation in the country or the world and the projected increase in demand (Belobaba, et al., 2009).

Unconstraining methods analyse the movements of a phenomenon in the past and the factors that influenced its movement. Attempts are being made to quantify the dependencies between them, and the very predictions of future trends and phenomena are based on the continuation of the current trend.

Aircraft capacity management systems, despite the development of forecasting methods, mainly use variations of standard, i.e., simpler methods – unconstraining methods. Due to the use of censored historical data, specific methods are used to forecast real demand that analyse the trends of past phenomena and the causes of these phenomena (Belobaba, et al., 2009). It is extremely important to accurately predict traffic demand for the efficient operation of the available aircraft seat management system, which is tasked with assigning available seats to different price ranges.

Demand data is the input parameter of all available aircraft seat management systems. Historical data, i.e., data on demand on flights operated in the past, on which the forecast of future demand is based, usually do not represent actual nor comprehensive demand. This is one of the main problems in forecasting the demand for air transport services in the context of aircraft capacity management systems. When an airline stops selling seats in a certain price range, valuable demand data collecting is stopped, and the rejected requests are not recorded anywhere. In this case, data on actual demand is censored, and such demand is called censored, truncated, or incomplete demand.

When actual demand data is unknown, there are three options:

- retention of truncated data, i.e., data that do not contain requests for capacity after the reservation limit has been reached,
- direct recording of hidden (unfulfilled) demand,
- estimating the actual demand using statistical methods, i.e., „upgrading“ censored data (Belobaba, et al., 2009).

In this chapter, the aim is to present the calculation of demand parameters  $\mu$  and  $\sigma$  after the application of simple and statistical methods of estimating actual demand.

Simple methods of estimating actual demand include methods that use only available data and methods that replace censored data with new values. For methods that use only available data, there are two methods: a method that ignores the existence of censorship (I1 method) and a method that rejects censored values (I2 method). For methods that replace censored data with



new values, there are three methods: the method of replacing censored data with the arithmetic mean or average of uncensored data (RWA<sup>2</sup> method), the method of replacing censored data with the median of uncensored data (RWM<sup>3</sup> method) and the method of replacing censored data with the percentile of uncensored data (RWP75<sup>4</sup> method).

Statistical methods of estimating actual demand include the method of upgrading the reservation curve (BP<sup>5</sup> method), the method of maximizing expectations (EM<sup>6</sup> method), the method of projecting actual demand (PD<sup>7</sup> method).

Table 12 shows example of the data on recorded demand for price class Q on 30 similar flights. The number of requests (reservations) in closed classes is marked in red (censored data).

**Table 12 Example of data (fictional) on recorded demand**

n	1	2	3	4	5	6	7	8	9	10	11	12	13	14	15	16	17	18	19	20	21	22	23	24	25	26	27	28	29	30
Number of demands	12	13	15	12	17	20	18	18	16	22	20	19	20	29	20	24	23	22	18	15	14	15	17	17	18	16	16	17	17	22

As an example, the calculations of the demand parameters  $\mu$  and  $\sigma$  (using the demand data from Table 12), for all eight methods of estimating the actual demand are presented in the following sub-chapters, as well as graphical representations of the probability density function and the probability distribution function when applying the EM and PD method.

---

2 Replace With Average  
 3 Replace With Median  
 4 Replace With Percentile  
 5 Booking Profile  
 6 Expectation Maximization  
 7 Projection Detrunction

4.4.5.1 Method that ignores the existence of censorship (I1 method)

The I1 method simply ignores the fact that some of the available data on recorded demand does not represent actual demand; it uses all available data, including those archived in the system after the „closing“ of a particular price range. The Microsoft Excel software tool was used to calculate the demand parameters using the I1 method. Table 13 shows the results of demand parameters obtained using the I1 method.

The following formula was used to calculate the parameter  $\mu$ :

$$=AVERAGE(\text{field of uncensored and censored data})$$

(1)

The following formula was used to calculate the parameter  $\sigma$ :

$$=STDEV(\text{field of uncensored and censored data})$$

(2)

Table 13 Calculation of demand parameters using I1 method

STEPS/ ITERATIONS	x (demand)																										$\mu$		$\sigma$			
	12	13	15	12	17	20	18	18	16	22	20	19	20	29	20	24	23	22	18	15	14	15	17	17	18	16	17	17	22	$\mu 0$	18,066667	$\sigma 0$

Source: Author using Microsoft Excel

4.4.5.2 Method that rejects censored values (I2 method)

The I2 method rejects censored values and limits the set of available recorded demand data to those that are not censored. The Microsoft Excel software tool was used to calculate the demand parameters using the I2 method. Table 14 shows the results of demand parameters obtained using the I2 method.

The following formula was used to calculate the parameter  $\mu$ :

$$=AVERAGE(\text{field of uncensored data})$$

(3)

The following formula was used to calculate the parameter  $\sigma$ :

$$=STDEV(\text{field of uncensored data})$$

(4)

Table 14 Calculation of demand parameters using I2 method

STEPS/ ITERATIONS	x (demand)																										$\mu$		$\sigma$				
	12	13	15	12	17	-	18	18	16	22	20	19	20	29	20	-	23	22	18	15	14	15	17	17	18	-	16	17	17	22	$\mu 0$	17,851852	$\sigma 0$

Source: Author using Microsoft Excel

#### 4.4.5.3 Replace With Average (RWA) method

The method of replacing censored data with the arithmetic mean, i.e., the average of uncensored data, is a common and frequently used method in the case of supplementing missing data. If the censored value is higher than the average calculated in this method, it is taken as data on actual demand, and if it is lower, it is replaced by the average of uncensored values. The Microsoft Excel software tool was used to calculate the demand parameters using the RWA method. Table 15 shows the results of the demand parameters obtained using the RWA method.

The following formula was used to calculate the parameter of uncensored data average ( $\mu_{NC}$ ):

$$=AVERAGE(\text{field of uncensored data}) \quad (5)$$

The following formula was used to calculate the parameter  $\mu$ :

$$=AVERAGE(\text{field with replaced censored data}) \quad (6)$$

The following formula was used to calculate the parameter  $\sigma$ :

$$=STDEV(\text{field with replaced censored data}) \quad (7)$$

**Table 15 Calculation of demand parameters using RWA method**

STEPS/ ITERATIONS	x (demand)																												$\mu_{NC}$		$\mu$		$\sigma$	
	12	13	15	12	17	-	18	18	16	22	20	19	20	29	20	-	23	22	18	15	14	15	17	17	18	-	16	17	17	22		17,851852		
	12	13	15	12	17	20	18	18	16	22	20	19	20	29	20	24	23	22	18	15	14	15	17	17	18	16	17	17	22	$\mu_0$	18,128395	$\sigma_0$	3,711712	

Source: Author using Microsoft Excel

#### 4.4.5.4 Replace With Median (RWM) method

The method of replacing censored data with the median of uncensored data is similar to the method of replacing censored data with the arithmetic mean of uncensored data, but instead of the arithmetic mean, censored data is replaced by the median of uncensored data. If the censored value is higher than the median, it is taken as the data on actual demand, and if it is lower, it is replaced by the median. The Microsoft Excel software tool was used to calculate the demand parameters using the RWM method. Table 16 shows the results of demand parameters obtained using the RWM method.

The following formula was used to calculate the parameter of uncensored data median ( $med_{NC}$ ):

$$=MEDIAN(\text{field of uncensored data}) \quad (8)$$

The following formula was used to calculate the parameter  $\mu$ :

$$=AVERAGE(\text{field with replaced censored data})$$

(9)

The following formula was used to calculate the parameter  $\sigma$ :

$$=STDEV(\text{field with replaced censored data})$$

(10)

**Table 16 Calculation of demand parameters using RWM method**

STEPS/ ITERATIONS	x (demand)																												medNC					
																													17,000000					
																													$\mu$		$\sigma$			
	12	13	15	12	17	-	18	18	16	22	20	19	20	29	20	-	23	22	18	15	14	15	17	17	18	-	16	17	17	22				
	12	13	15	12	17	20	18	18	16	22	20	19	20	29	20	24	23	22	18	15	14	15	17	17	18	16	17	17	22					
	12	13	15	12	17	20	18	18	16	22	20	19	20	29	20	24	23	22	18	15	14	15	17	17	18	17	16	17	17	22	$\mu_0$	18,100000	$\sigma_0$	3,717155

Source: Author using Microsoft Excel

#### 4.4.5.5 Replace With Percentile (RWP75) method

The RWP75 method is similar to the method of replacing censored data with the arithmetic mean or median of uncensored data, but the third or upper quartile is used instead. If the censored value is higher than the upper quartile (percentile), it is taken as data on actual demand, and if it is lower, it is replaced by the upper quartile (percentile). The Microsoft Excel software tool was used to calculate the demand parameters using the RWP75 method. Table 17 shows the results of the demand parameters obtained using the RWP75 method.

The following formula was used to calculate the parameter of uncensored data percentile (*percNC*):

$$=PERCENTILE(\text{field of uncensored data};k), \text{ where } k \text{ is a value between 0 and 1, i.e., in this case it is equal to } 0,75$$

(11)

The following formula was used to calculate the parameter  $\mu$ :

$$=AVERAGE(\text{field with replaced censored data})$$

(12)

The following formula was used to calculate the parameter  $\sigma$ :

$$=STDEV(\text{field with replaced censored data})$$

(13)

Table 17 Calculation of demand parameters using RWP75 method

STEPS/ ITERATIONS	x (demand)																												k	percNC	μ		σ	
																													0,75	20,000000				
	12	13	15	12	17	-	18	18	16	22	20	19	20	29	20	-	23	22	18	15	14	15	17	17	18	-	16	17	17	22				
	12	13	15	12	17	20	18	18	16	22	20	19	20	29	20	24	23	22	18	15	14	15	17	17	18	16	17	17	22					
	12	13	15	12	17	20	18	18	16	22	20	19	20	29	20	24	23	22	18	15	14	15	17	17	18	20	16	17	17	22	μ0	18,200000	σ0	3,726883

Source: Author using Microsoft Excel

4.4.5.6 Booking Profile (BP) method

The method of upgrading the reservation curve (BP method) determines actual demand based on the shape of the cumulative number of reservations curve and assumes that for similar flights the appearance of the reservation curve of a certain price range does not depend on demand intensity, i.e., that the percentage increase between adjacent checkpoints is constant for a group of similar flights. Uncensored bookings (reservations), which are likely to be lower demand flights, are averaged at each checkpoint and PI increase coefficients are calculated for every two adjacent checkpoints. Censored data is upgraded so that the last uncensored data at some previous checkpoint is increased by the determined PI percentages. Assuming that the percentage increase (PI) between the previous checkpoint and the checkpoint at which the default data (OB) was recorded, and that the limit was reached at the previous checkpoint, the censored values will be replaced by (UD) values, as shown in Table 18. The Microsoft Excel software tool was used to calculate the UD(ri) parameters.

The following formula was used to calculate the parameter UD(ri):

$$=ROUND([UD(r9)]*(1+[PI(r10)]);0), \text{ where for example } [UD(r9)]=22, [PI(r10)]=31\% \text{ (Table 14)}$$

(14)

Table 18 Calculation of demand parameters using BP method

	r1	r2	r3	r4	r5	r6	r7	r8	r9	r10	r11	r12	r13	r14	r15
PI	-									31%	24%	17%	13%	8%	3%
OB(ri)	0	2	4	7	9	12	15	19	22	25	25	25	25	25	25
UD(ri)	0	2	4	7	9	12	15	19	22	29	36	42	47	51	53

Source: Author using Microsoft Excel

#### 4.4.5.7 Expectation Maximization (EM) method

The EM algorithm (expectation maximization algorithm) is a general-purpose algorithm for estimating the maximum probability of distributing incomplete data. It is used when it is necessary to calculate a set of parameters that describe the hidden probability distribution, and when only part of the data is available.

There are E and M steps, which alternate, starting with the E-step in which expectations are calculated, using the initial values of the average and the standard deviation in zero iteration (Table 19, parameters  $E1$ ,  $E2$  and  $E3$ ). Then  $\mu1$  and  $\sigma1$  are calculated under the condition of replacing the censored values with previously obtained expectations. The Microsoft Excel software tool was used to calculate the demand parameters using the EM method. Table 19 shows the results of demand parameters obtained using the EM method.

The following formula was used to calculate the expectation parameter ( $E1$ ,  $E2$ ,  $E3$ ):

$$=((\text{NORMDIST}(c_i;\mu;\sigma;\text{FALSE})*\sigma*\sigma)/(\text{1-NORMDIST}(c_i;\mu;\sigma;\text{TRUE}))) + \mu, \text{ where } c_i \text{ is the censored value, for } i=1,2,3. \quad (15)$$

The following formula was used to calculate the parameter  $\mu$ :

$$=\text{AVERAGE}(\text{field with censored data replaced with } E1, E2, E3). \quad (16)$$

The following formula was used to calculate the parameter  $\sigma$ :

$$=\text{STDEV}(\text{field with censored data replaced with } E1, E2, E3). \quad (17)$$

The steps (iterations) are repeated until the following conditions are met (convergence criteria):

$$|\sigma(k) - \sigma(k-1)| < \delta \ \& \ |\mu(k) - \mu(k-1)| < \delta, \text{ where the convergence criterion is } \delta = 0,0001. \quad (18)$$

Table 19 shows that the convergence criteria are met in step 5 (iteration). For these values of demand ( $x$ ), average ( $\mu$ ) and standard deviation ( $\sigma$ ), the probability density function ( $f(x)$ ) and the probability distribution function ( $F(x)$ ) are calculated below.

The Microsoft Excel software tool was used to calculate the values of probability density functions ( $f(x)$ ) using the EM method. The probability density function ( $f(x)$ ) is calculated by the following formula:

$$f(x)=\text{NORMDIST}(x;\mu;\sigma;\text{FALSE}) \quad (19)$$

The Microsoft Excel software tool was used to calculate the values of probability distribution functions ( $F(x)$ ) using the EM method. The probability distribution function ( $F(x)$ ) is calculated by the following formula:

$$F(x)=\text{NORMDIST}(x;\mu;\sigma;\text{TRUE})$$

(20)

All values of demand ( $x$ ), average ( $\mu$ ) and standard deviation ( $\sigma$ ) and values of the probability density function ( $f(x)$ ) and the probability distribution function ( $F(x)$ ) are shown in Table 20 below. The graph of probability density functions ( $f(x)$ ) using the EM method is shown in Figure 42, and the graph of probability distribution functions ( $F(x)$ ) using the EM method is shown in Figure 43.

Table 19 Calculation of demand parameters using EM method

STEPS/ ITERATIONS	x (demand)																						$\mu$		$\sigma$		E1	E2	E3	$ \sigma(k) - \sigma(k-1)  < \delta$	$ \mu(k) - \mu(k-1)  < \delta$								
	12	13	15	12	17	20	18	18	16	22	20	19	20	29	20	24	23	22	18	15	14	15	17	17	18	16	17	17	22										
0	12	13	15	12	17	-	18	18	16	22	20	19	20	29	20	-	23	22	18	15	14	15	17	17	18	-	16	17	17	22	0	17,851852	0	3,717978	-	-	-	-	-
1	12	13	15	12	17	22	18	18	16	22	20	19	20	29	20	26	23	22	18	15	14	15	17	17	18	20	16	17	17	22	1	18,320178	1	3,875329	22,307678	25,549098	19,748568	0,468326	0,157351
2	12	13	15	12	17	23	18	18	16	22	20	19	20	29	20	26	23	22	18	15	14	15	17	17	18	20	16	17	17	22	2	18,345904	2	3,900386	22,555027	25,720125	20,101966	0,025726	0,025057
3	12	13	15	12	17	23	18	18	16	22	20	19	20	29	20	26	23	22	18	15	14	15	17	17	18	20	16	17	17	22	3	18,348554	3	3,903236	22,581804	25,740810	20,133998	0,002650	0,002850
4	12	13	15	12	17	23	18	18	16	22	20	19	20	29	20	26	23	22	18	15	14	15	17	17	18	20	16	17	17	22	4	18,348847	4	3,903554	22,584776	25,743126	20,137500	0,000293	0,000318
5	12	13	15	12	17	23	18	18	16	22	20	19	20	29	20	26	23	22	18	15	14	15	17	17	18	20	16	17	17	22	5	18,348879	5	3,903589	22,585106	25,743383	20,137889	0,000033	0,000035
6	12	13	15	12	17	23	18	18	16	22	20	19	20	29	20	26	23	22	18	15	14	15	17	17	18	20	16	17	17	22	6	18,348883	6	3,903593	22,585143	25,743412	20,137932	0,000004	0,000004
7	12	13	15	12	17	23	18	18	16	22	20	19	20	29	20	26	23	22	18	15	14	15	17	17	18	20	16	17	17	22	7	18,348883	7	3,903594	22,585147	25,743415	20,137937	0,000000	0,000000

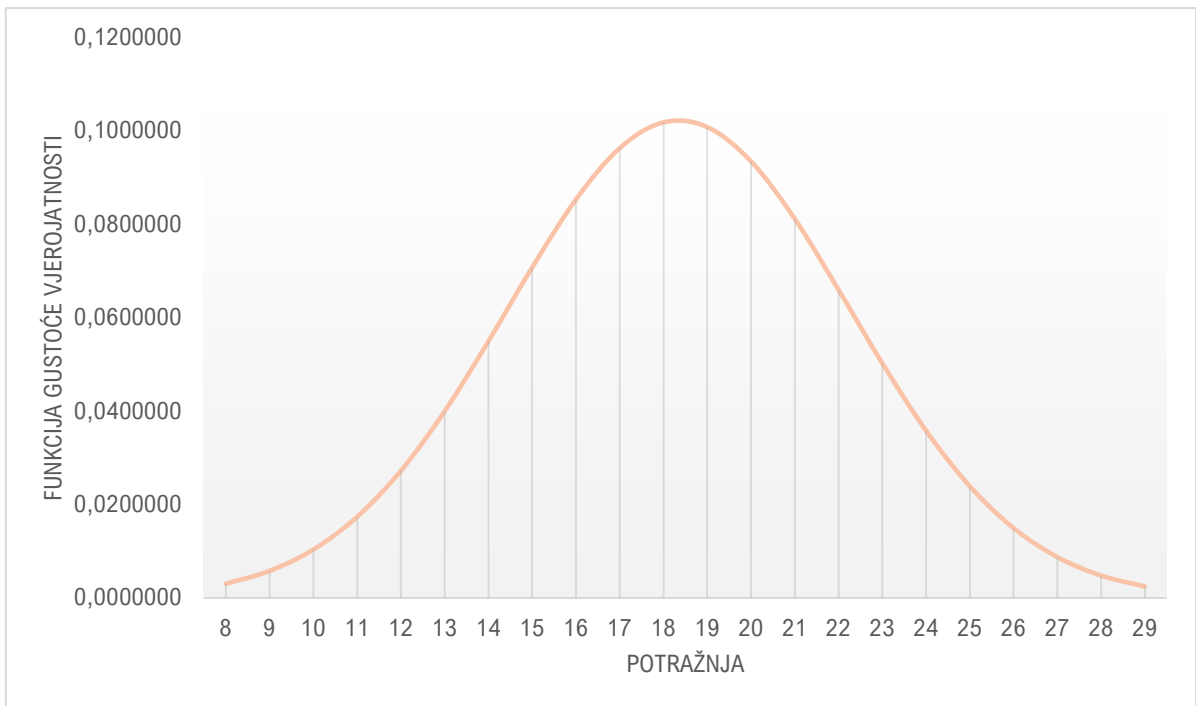
Source: Author using Microsoft Excel

Table 20 Calculation of the values of the probability density function and the probability distribution function (for demand parameters obtained using the EM method)

x	$\mu$	$\sigma$	f(x)	F(x)
8	18,348	3,903	0,0030416	0,0040092
9	18,348	3,903	0,0058058	0,0083084
10	18,348	3,903	0,0103781	0,0162232
11	18,348	3,903	0,0173723	0,0298736
12	18,348	3,903	0,0272326	0,0519279
13	18,348	3,903	0,0399772	0,0853079
14	18,348	3,903	0,0549573	0,1326364
15	18,348	3,903	0,0707505	0,1955010
16	18,348	3,903	0,0852951	0,2737240
17	18,348	3,903	0,0962962	0,3649061
18	18,348	3,903	0,1018088	0,4644765
19	18,348	3,903	0,1007980	0,5663350
20	18,348	3,903	0,0934564	0,6639487
21	18,348	3,903	0,0811441	0,7515823
22	18,348	3,903	0,0659774	0,8252837
23	18,348	3,903	0,0502371	0,8833505
24	18,348	3,903	0,0358216	0,9262078
25	18,348	3,903	0,0239197	0,9558403
26	18,348	3,903	0,0149574	0,9750338
27	18,348	3,903	0,0087589	0,9866801
28	18,348	3,903	0,0048032	0,9933002
29	18,348	3,903	0,0024666	0,9968254

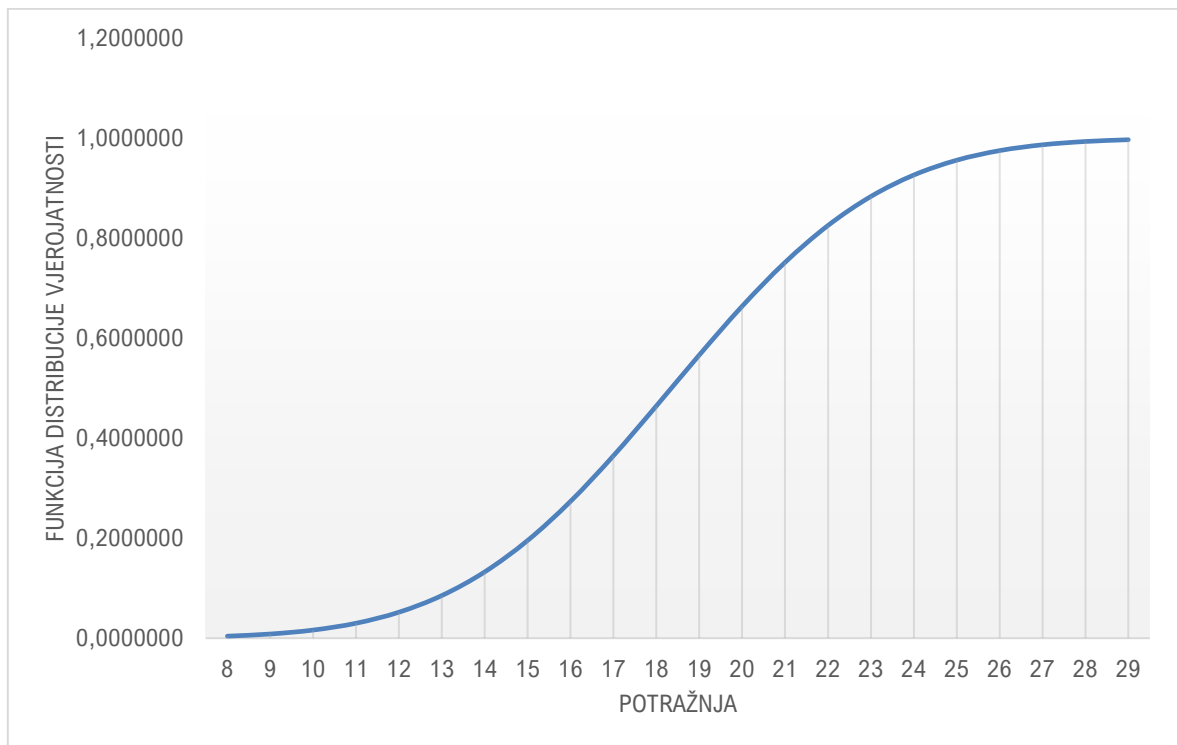
Source: Author using Microsoft Excel





**Figure 42 Probability density function (EM method)**

*Source: Author using Microsoft Excel*



**Figure 43 Probability distribution function (EM method)**

*Source: Author using Microsoft Excel*

#### 4.4.5.8 Projection Detruncion (PD) method

The PD method (actual demand projection method) is very similar to the EM method. It starts from the assumption of normal distribution of demand and first calculates the average value of the number of requests for „open“ flights. It then uses an arbitrary value of  $\tau$  to estimate demand on „closed“ flights. Furthermore, for all observed flights, both „open“ and those with projected demand, expectation and standard deviation are calculated. The process is repeated for „closed“ flights until the projected values (both expectation and standard deviation) begin to converge.

There are E and M steps, which alternate, starting with the E-step in which expectations are calculated, using the initial average values and the standard deviation in zero iteration (Table 21, parameters  $E1$ ,  $E2$  and  $E3$ ). Then  $\mu1$  and  $\sigma1$  are calculated under the condition of replacing the censored values with previously obtained expectations. The Microsoft Excel software tool was used to calculate the demand parameters using the PD method. Table 21 shows the results of demand parameters obtained using the PD method.

The following formula was used to calculate the expectation parameter ( $E1$ ,  $E2$ ,  $E3$ ):

$$=NORMINV((1-\tau*(1-NORMDIST(c_i;\mu;\sigma;TRUE)));;\mu;\sigma) \text{ where } c_i \text{ is the censored value, for } i=1,2,3. \quad (21)$$

The following formula was used to calculate the parameter  $\mu$ :

$$=AVERAGE(\text{field with censored data replaced with } E1, E2, E3). \quad (22)$$

The following formula was used to calculate the parameter  $\sigma$ :

$$=STDEV(\text{field with censored data replaced with } E1, E2, E3). \quad (23)$$

The steps (iterations) are repeated until the following conditions are met (convergence criteria):

$$|\sigma(k) - \sigma(k-1)| < \delta \ \& \ |\mu(k) - \mu(k-1)| < \delta, \text{ where the convergence criterion is } \delta = 0,0001. \quad (24)$$

Table 21 shows that the convergence criteria are met in step 5 (iteration). For these values of demand ( $x$ ), average ( $\mu$ ) and standard deviation ( $\sigma$ ), the probability density function ( $f(x)$ ) and the probability distribution function ( $F(x)$ ) are calculated below.

The Microsoft Excel software tool was used to calculate the values of probability density functions ( $f(x)$ ) using the PD method. The probability density function ( $f(x)$ ) is calculated by the following formula:

$$f(x)=NORMDIST(x;\mu;\sigma;FALSE) \quad (25)$$

The Microsoft Excel software tool was used to calculate the values of probability distribution functions ( $F(x)$ ) using the PD method. The probability distribution function ( $F(x)$ ) is calculated by the following formula:

$$F(x)=\text{NORMDIST}(x;\mu;\sigma;\text{TRUE})$$

(26)

All values of demand ( $x$ ), average ( $\mu$ ) and standard deviation ( $\sigma$ ) and values of the probability density function ( $f(x)$ ) and the probability distribution function ( $F(x)$ ) are shown in Table 22 below. The graph of probability density functions ( $f(x)$ ) using the PD method is shown in Figure 44, and the graph of probability distribution functions ( $F(x)$ ) using the PD method is shown in Figure 45.

**Table 21 Calculation of demand parameters using PD method**

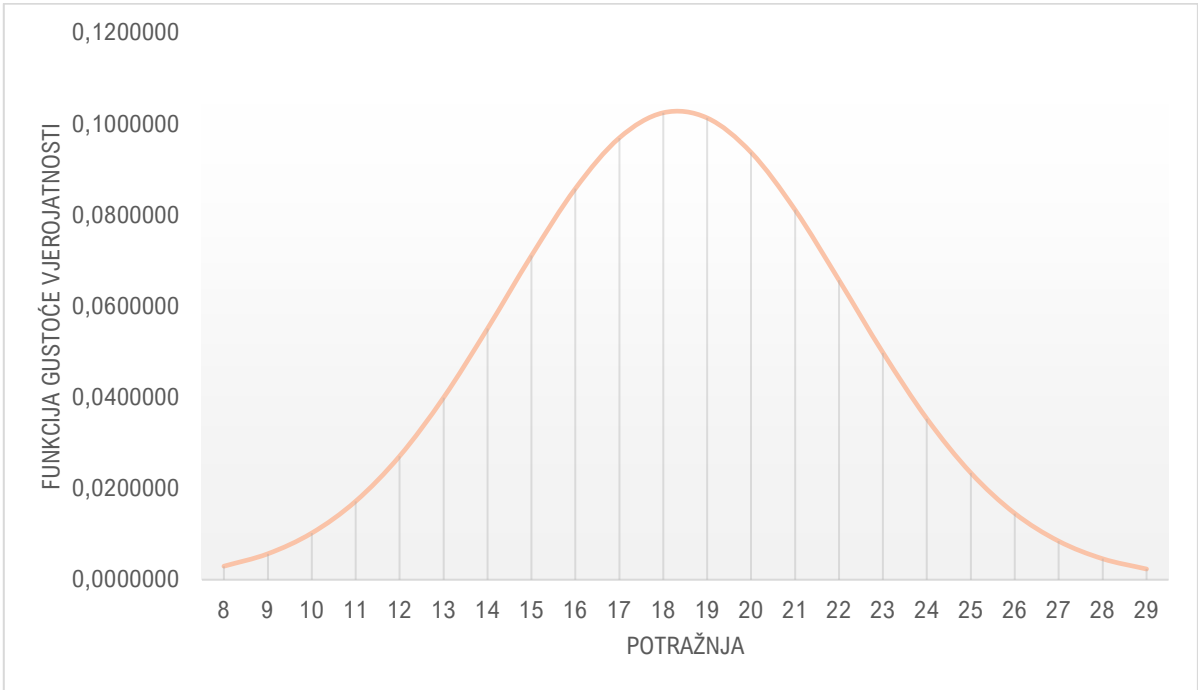
STEPS/ ITERATIONS	x (demand)																						$\mu$	$\sigma$	E1	E2	E3	$ \sigma(k) - \sigma(k-1)  < \delta$	$ \mu(k) - \mu(k-1)  < \delta$										
	12	13	15	12	17	20	18	18	16	22	20	19	20	29	20	24	23	22	18	15	14	15								17	17	18	16	17	17	22			
0	12	13	15	12	17	-	18	18	16	22	20	19	20	29	20	-	23	22	18	15	14	15	17	17	18	-	16	17	17	22	0	17,851852	0	3,717978	-	-	-	-	-
1	12	13	15	12	17	22	18	18	16	22	20	19	20	29	20	25	23	22	18	15	14	15	17	17	18	20	16	17	17	22	1	18,303896	1	3,853517	22,097034	25,333427	19,686420	0,452044	0,135539
2	12	13	15	12	17	22	18	18	16	22	20	19	20	29	20	25	23	22	18	15	14	15	17	17	18	20	16	17	17	22	2	18,327945	2	3,875270	22,323311	25,476099	20,038930	0,024049	0,021753
3	12	13	15	12	17	22	18	18	16	22	20	19	20	29	20	25	23	22	18	15	14	15	17	17	18	20	16	17	17	22	3	18,330244	3	3,877601	22,346419	25,492729	20,068178	0,002300	0,002331
4	12	13	15	12	17	22	18	18	16	22	20	19	20	29	20	25	23	22	18	15	14	15	17	17	18	20	16	17	17	22	4	18,330481	4	3,877844	22,348816	25,494474	20,071151	0,000237	0,000243
5	12	13	15	12	17	22	18	18	16	22	20	19	20	29	20	25	23	22	18	15	14	15	17	17	18	20	16	17	17	22	5	18,330506	5	3,877869	22,349065	25,494656	20,071459	0,000025	0,000025
6	12	13	15	12	17	22	18	18	16	22	20	19	20	29	20	25	23	22	18	15	14	15	17	17	18	20	16	17	17	22	6	18,330509	6	3,877871	22,349090	25,494674	20,071491	0,000003	0,000003
7	12	13	15	12	17	22	18	18	16	22	20	19	20	29	20	25	23	22	18	15	14	15	17	17	18	20	16	17	17	22	7	18,330509	7	3,877872	22,349093	25,494676	20,071494	0,000000	0,000000

Source: Author using Microsoft Excel

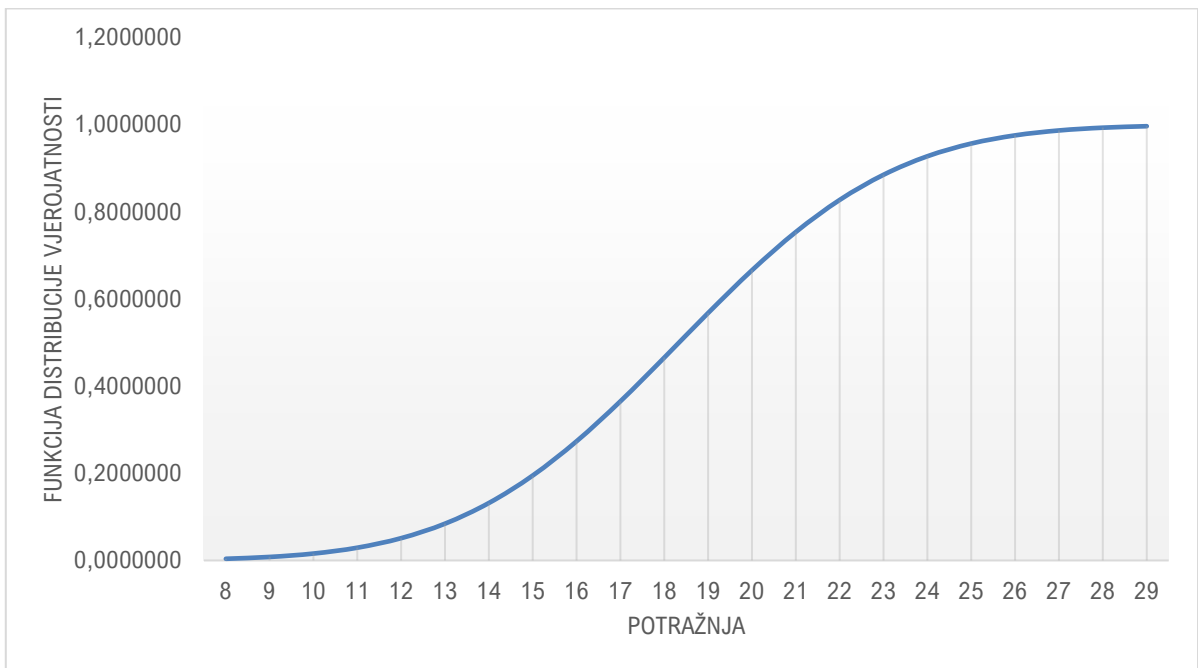
**Table 22 Calculation of the values of the probability density function and the probability distribution function (for demand parameters obtained using the PD method)**

x	$\mu$	$\sigma$	f(x)	F(x)
8	18,331	3,878	0,0029596	0,0038609
9	18,331	3,878	0,0056902	0,0080611
10	18,331	3,878	0,0102365	0,0158461
11	18,331	3,878	0,0172304	0,0293517
12	18,331	3,878	0,0271370	0,0512826
13	18,331	3,878	0,0399899	0,0846157
14	18,331	3,878	0,0551392	0,1320372
15	18,331	3,878	0,0711366	0,1951846
16	18,331	3,878	0,0858711	0,2738923
17	18,331	3,878	0,0969890	0,3657172
18	18,331	3,878	0,1024992	0,4659903
19	18,331	3,878	0,1013538	0,5684823
20	18,331	3,878	0,0937738	0,6665391
21	18,331	3,878	0,0811792	0,7543496
22	18,331	3,878	0,0657552	0,8279528
23	18,331	3,878	0,0498353	0,8856996
24	18,331	3,878	0,0353400	0,9281069
25	18,331	3,878	0,0234486	0,9572566
26	18,331	3,878	0,0145576	0,9760111
27	18,331	3,878	0,0084564	0,9873055
28	18,331	3,878	0,0045962	0,9936718
29	18,331	3,878	0,0023374	0,9970308

Source: Author using Microsoft Excel



**Figure 44 Probability density function (PD method)**  
*Source: Author using Microsoft Excel*



**Figure 45 Probability distribution function (PD method)**  
*Source: Author using Microsoft Excel*

#### **4.5 Overview of predictive methods applicable in aviation safety management**

In previous chapters from 4.4.3 to 4.4.5, forecasting methods used in aviation, are described and presented.

Forecasting methods in air navigation services include time series methods for extrapolating historical data samples, econometric analyses that consider how economic, social and operational conditions affect the development of transport, scenario-based inputs that describe future developments in Europe over the next ten years, specific data-driven models; these methods rely on historical data or on tracking the latest trends.

Forecasting methods in airport operations include methods of time series analysis which include trend projection methods and time series decomposition methods, i.e., simple exponential smoothing, exponential smoothing method with trend and seasonality, moving average method, auto regression model that integrates moving average (ARIMA).

Forecasting (estimating) methods in airline operations include simple and statistical methods of estimating actual demand. Simple methods of estimating actual demand include methods that use only available data and methods that replace censored data with new values. For methods that use only available data, there are two methods: a method that ignores the existence of censorship (I1 method) and a method that rejects censored values (I2 method). For methods that replace censored data with new values, there are three methods: the method of replacing censored data with the arithmetic mean or average of uncensored data (RWA method), the method of replacing censored data with the median of uncensored data (RWM method) and the method of replacing censored data with the percentile of uncensored data (RWP75 method). Statistical methods of estimating actual demand include the method of upgrading the reservation curve (BP method), the method of maximizing expectations (EM method), the method of projecting actual demand (PD method).

After analysing available examples of forecasting methods, the following methods are selected to be applicable in aviation safety management: methods of time series analysis which include trend projection, simple exponential smoothing, exponential smoothing method with trend and seasonality, moving average method, auto regression model that integrates moving average (ARIMA). Nine methods are selected to be tested as appropriate for aviation safety management, i.e., Holt's linear trend, Brown's linear trend, damped trend, simple exponential smoothing, simple seasonal exponential smoothing, Winter's additive method, Winter's multiplicative method, moving average method, and ARIMA modelling.

An overview of selected predictive methods applicable in aviation safety management are presented in Table 23. The best fit is proven to be simple seasonal exponential smoothing, Winter's additive method, moving average method, and ARIMA modelling.

**Table 23 Selected predictive methods applicable in aviation safety management**

Timeline	HOLT'S LINEAR TREND				BROWN'S LINEAR TREND				DAMPED TREND				SIMPLE EXPONENTIAL SMOOTHING				SIMPLE SEASONAL EXPONENTIAL SMOOTHING				WINTER'S ADDITIVE METHOD				WINTER'S MULTIPLICATIVE METHOD				MOVING AVERAGE METHOD				ARIMA MODELING ARIMA(0,1,1)(1,1,0)			
	RMSE = 454.187				RMSE = 489.109				RMSE = 437.490				RMSE = 448.684				RMSE = 358.459				RMSE = 373.104				RMSE = 454.465				RMSE = 403.010				RMSE = 430.170			
	Values	Forecast	LCL	UCL	Values	Forecast	LCL	UCL	Values	Forecast	LCL	UCL	Values	Forecast	LCL	UCL	Values	Forecast	LCL	UCL	Values	Forecast	LCL	UCL	Values	Forecast	LCL	UCL	Values	Forecast	LCL	UCL	Values	Forecast	LCL	UCL
Dec-17	2912				2912				2912				2912				2912				2912				2912				2912				2912			
Jan-18	3039				3039				3039				3039				3039				3039				3039				3039				3039			
Feb-18	2692				2692				2692				2692				2692				2692				2692				2692				2692			
Mar-18	3143				3143				3143				3143				3143				3143				3143				3143				3143			
Apr-18	3384				3384				3384				3384				3384				3384				3384				3384				3384			
May-18	4023				4023				4023				4023				4023				4023				4023				4023				4023			
Jun-18	4124				4124				4124				4124				4124				4124				4124				4124				4124			
Jul-18	4461				4461				4461				4461				4461				4461				4461				4461				4461			
Aug-18	4393				4393				4393				4393				4393				4393				4393				4393				4393			
Sep-18	4176				4176				4176				4176				4176				4176				4176				4176				4176			
Oct-18	3970				3970				3970				3970				3970				3970				3970				3970				3970			
Nov-18	3223				3223				3223				3223				3223				3223				3223				3223				3223			
Dec-18	3060				3060				3060				3060				3060				3060				3060				3060				3060			
Jan-19	3045				3045				3045				3045				3045				3045				3045				3045				3045			
Feb-19	2826				2826				2826				2826				2826				2826				2826				2826				2826			
Mar-19	3356				3356				3356				3356				3356				3356				3356				3356				3356			
Apr-19	3776				3776				3776				3776				3776				3776				3776				3776				3776			
May-19	4283				4283				4283				4283				4283				4283				4283				4283				4283			
Jun-19	4088				4088				4088				4088				4088				4088				4088				4088				4088			
Jul-19	4356				4356				4356				4356				4356				4356				4356				4356				4356			
Aug-19	4401				4401				4401				4401				4401				4401				4401				4401				4401			
Sep-19	4190				4190				4190				4190				4190				4190				4190				4190				4190			
Oct-19	4045				4045				4045				4045				4045				4045				4045				4045				4045			
Nov-19	3344				3344				3344				3344				3344				3344				3344				3344				3344			
Dec-19	3351				3351				3351				3351				3351				3351				3351				3351				3351			
Jan-20	3133				3133				3133				3133				3133				3133				3133				3133				3133			
Feb-20	2994				2994				2994				2994				2994				2994				2994				2994				2994			
Mar-20	2310				2310				2310				2310				2310				2310				2310				2310				2310			
Apr-20	365				365				365				365				365				365				365				365				365			
May-20	572				572				572				572				572				572				572				572				572			
Jun-20	1138				1138				1138				1138				1138				1138				1138				1138				1138			
Jul-20	2037				2037				2037				2037				2037				2037				2037				2037				2037			
Aug-20	2246				2246				2246				2246				2246				2246				2246				2246				2246			
Sep-20	1995				1995				1995				1995				1995				1995				1995				1995				1995			
Oct-20	1772				1772				1772				1772				1772				1772				1772				1772				1772			
Nov-20	1556				1556				1556				1556				1556				1556				1556				1556				1556			
Dec-20	1392				1392				1392				1392				1392				1392				1392				1392				1392			
Jan-21	1403				1403				1403				1403				1403				1403				1403				1403				1403			
Feb-21	1249				1249				1249				1249				1249				1249				1249				1249				1249			
Mar-21	1648				1648				1648				1648				1648				1648				1648				1648				1648			
Apr-21	1840				1840				1840				1840				1840				1840				1840				1840				1840			
May-21	2092				2092				2092				2092				2092				2092				2092				2092				2092			
Jun-21	2426				2426				2426				2426				2426				2426				2426				2426				2426			
Jul-21	2931				2931				2931				2931				2931				2931				2931				2931				2931			
Aug-21	3086				3086				3086				3086				3086				3086				3086				3086				3086			
Sep-21	3401				3401				3401				3401				3401				3401				3401				3401				3401			





## 5 CORRELATIONS BETWEEN AVIATION SAFETY MANAGEMENT METHODOLOGIES

Focus of this chapter is on determining correlations between safety management methodologies in aviation. First part outlines the theoretical overview of defining safety performance indicators (SPIs) as a bridge between safety management methodologies. Second part shows case study on determining liaison between proactive and predictive safety management methodology, using sample aviation training organisation. Third part reconciles all conclusions derived from first and second part, and explains in detail, defined liaison between reactive, proactive, and predictive safety management methodology in aviation.

### 5.1 Safety performance indicators as a bridge between safety management methodologies – theoretical overview

Safety performance of an organisation is monitored and measured via defined parameters called safety performance indicators (SPIs), i.e., every organisation has a regulatory obligation to define and monitor their SPIs. Organisations usually measure indicators such as number of accidents or incidents, number of changes, number of findings related to safety, etc., in relation to time frame (monthly or yearly basis) or to conducted operations (aircraft operations made or flight hours flown). It gives an organisation a guidance to where organisation has been; where is it now; and where is it heading, in relation to its safety performance. In order to find liaisons between safety management methodologies, safety performance indicators are observed in each separate safety management system, i.e., reactive, proactive and predictive, to present them as a bridge between safety management methodologies.

Figure 46 shows how safety performance indicator (SPI – Number of accidents or serious incidents) behaves in reactive safety management system. It can be observed that SPI is monitored and recorded over time but reaction to each occurrence happens after occurrence has happened. Decision on mitigative and preventive measures are made after conducting investigation and determining causes of event.

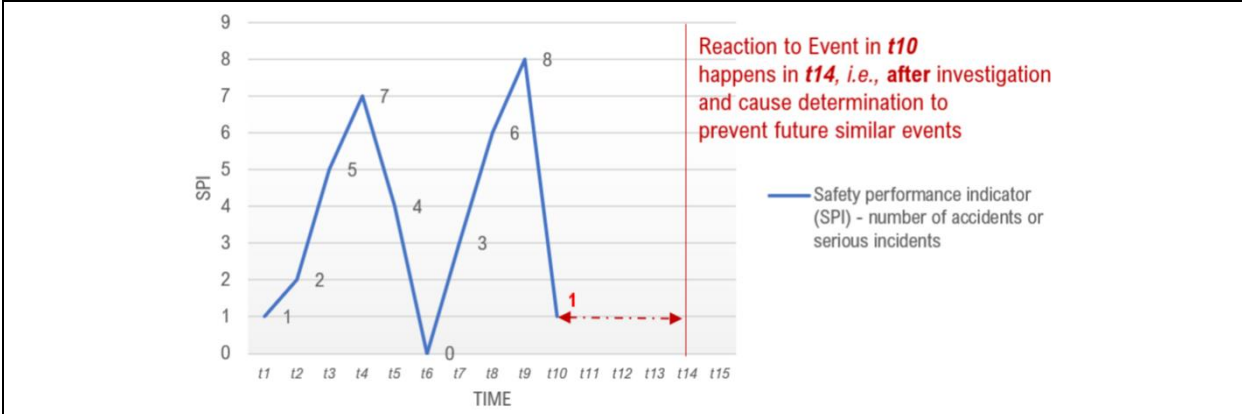
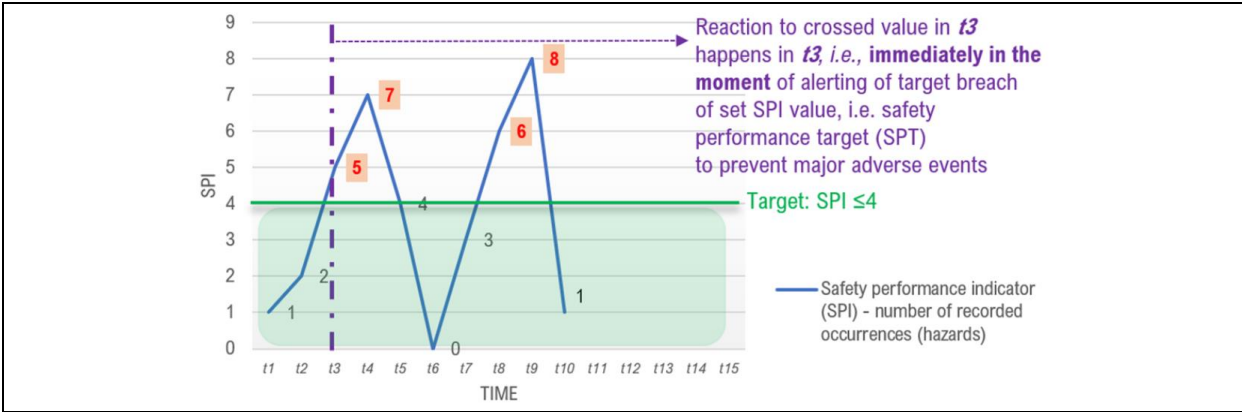


Figure 46 Safety performance indicator (SPI) in reactive safety management system

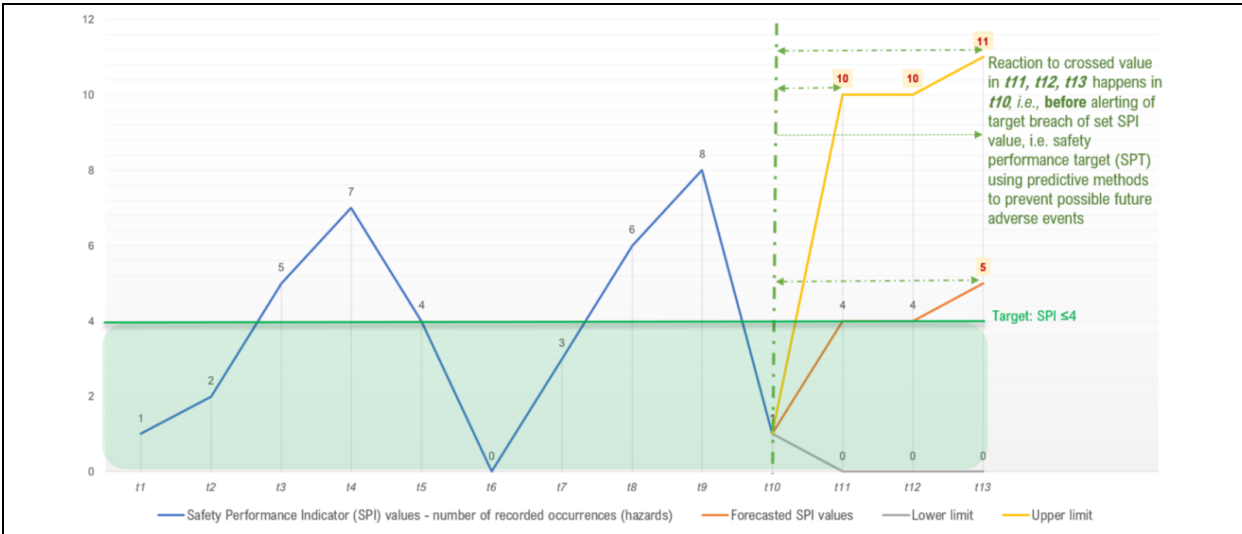
Source: Author

Figure 47 shows how safety performance indicator (SPI – Number of accidents or serious incidents) behaves in proactive safety management system. It can be observed that SPI is monitored and recorded over time with set safety performance target (SPT) and reaction to each occurrence happens in the moment occurrence has happened. Decision on mitigative and preventive measures are made right upon obtaining information on breaching the target area.



**Figure 47 Safety performance indicator (SPI) in proactive safety management system**  
 Source: Author

Figure 48 shows how safety performance indicator (SPI – Number of accidents or serious incidents) could behave in predictive safety management system. It can be observed that SPI would be monitored and recorded over time with set safety performance target (SPT), and with use of predictive methods, its behaviour could be forecasted for the future period. Reaction to each breach in the future (predicted at time points where occurrence is likely to happen) could be made before breach (occurrence) happens. Decision on mitigative and preventive measures in this case, could be made before breaching the target area.



**Figure 48 Safety performance indicator (SPI) in predictive safety management system**  
 Source: Author

## **5.2 Case study: Liaison between proactive and predictive safety management methodology on the sample aviation training organisation**

The focus of this chapter is to show liaison between proactive and predictive methodology of safety management systems in order to obtain improved and more efficient SMS. For the purpose of this research, actual safety data of an aviation training organisation, which requested to stay anonymous (X organisation), were used to show the liaison of two safety methodologies as an example.

The aviation training organisation (X) is an organisation that provides the services of pilot training; hence it is certified by the national authority as the Approved Training Organisation (ATO). Since it owns its own fleet of aircraft, X is also certified as Aircraft Maintenance Organisation (AMO) and Continuing Airworthiness Management Organisation (CAMO). As it provides the pilot training for the level of commercial pilot licence (CPL) it is required to provide the synthetic flight training as well, hence it is certified as Flight Simulation Training Device (FSTD) Operator. X is therefore certified as four different organisations (X, 2020), where each organisation requires to have well implemented and maintained SMS. Therefore, X has implemented one unique SMS adjusted to monitor safety occurrences (hazards) of all four organisations.

### **5.2.1 Examples of application of reactive and proactive methodology in an aviation training organisation**

Applied safety management methodologies in X, to gather safety information and data, are reactive and proactive. X has established safety reporting system which enables gathering safety data. There are three categories of reports that are gathered: mandatory, voluntary and changes. Mandatory reports refer to set of occurrences which are predetermined by the regulations with the obligation to report. Voluntary reports record potentially hazardous occurrences which are not predefined in the scope of mandatory occurrences. Reports on changes record every change that happens inside or outside the organisation, since every change represents potential hazard, and those reports can refer to internal changes (within organisation) or external changes (usually in regulations). Mandatory report is made when occurrence has already happened, hence it can be characterised as reactive methodology of gathering safety data. Voluntary reports and reports on changes record potential threats and hazards that could possibly or potentially lead to more serious occurrence, therefore those reports are characterised as proactive methodology of safety management. The predictive methods of safety management are not established nor implemented in X.

As a part of the Safety Assurance component, X has established several Safety Performance Indicators (SPIs). SPIs are monitored on yearly basis to show the safety performance of the organisation. Targets for some of the SPIs are set, and for some are not. The safety data and SPIs of the X's SMS are presented and elaborated in the following tables and figures (X, 2020).

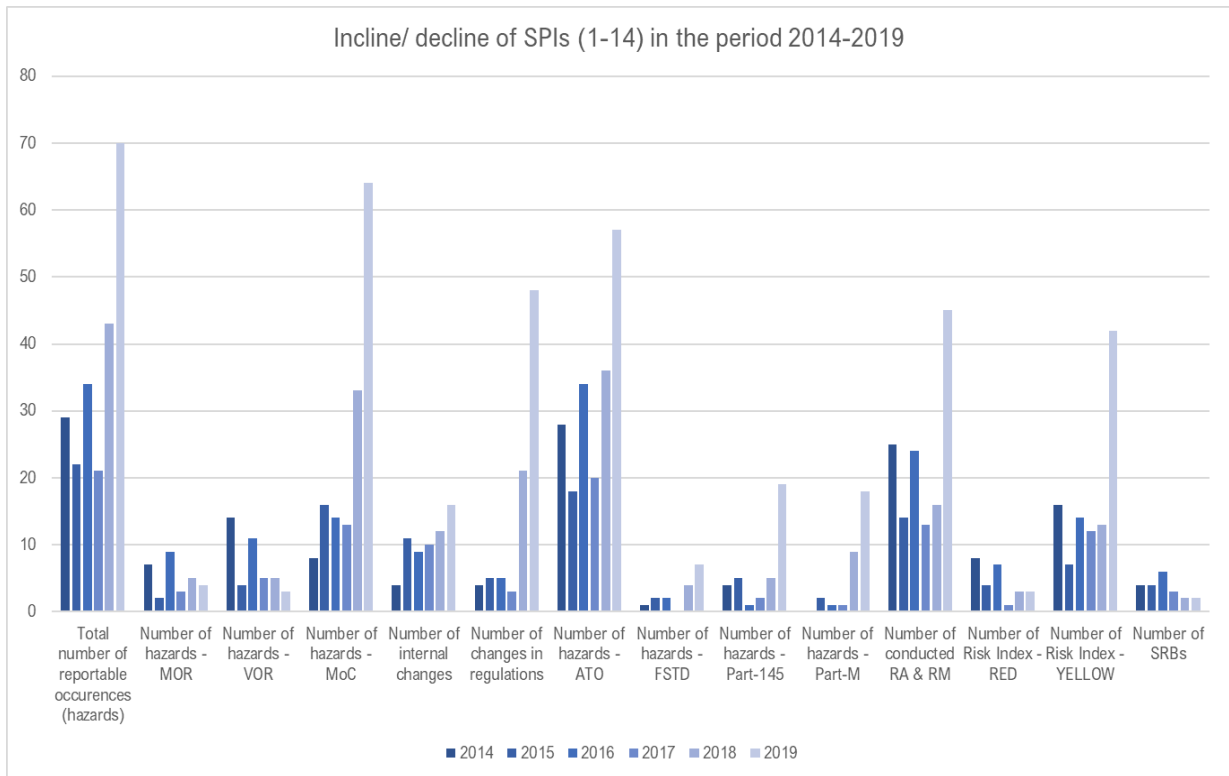
Table 24 shows X actual safety data and safety performance indicators (SPIs) in the period from 2014 to 2019 (X, 2020). There are 15 defined SPIs: Total number of reported hazards (SPI1), Number of hazards/ reported via Mandatory Occurrence Report – MOR (SPI2), Number of hazards reported via Voluntary Occurrence Report – VOR (SPI3), Number of hazards reported as Management of Change – MoC (SPI4), Number of hazards reported as an internal change in Management of Change – MoC (SPI5), Number of hazards reported as an external change (regulations) in Management of Change – MoC (SPI6), Number of hazards reported in the ATO organisation (SPI7), Number of hazards reported at the FSTD operator (SPI8), Number of hazards reported in the AMO organisation (SPI9), Number of hazards reported in the CAMO organisation (SPI10), Number of conducted risk assessments and mitigations (SPI11), Number of Risk Index evaluated as RED i.e. unacceptable (SPI12), Number of Risk Index evaluated as YELLOW i.e. tolerable (SPI13), Number of conducted Safety Review Boards – SRBs (SPI14), and Number of reported occurrences vs. number of flight hours (SPI15). The last column shows achieved number of flight hours during each year in the period from 2014 to 2019, and it is necessary to calculate SPI15. Last two rows show target areas for five SPIs: SPI1, SPI2, SPI11, SPI14 and SPI15 (marked in green).

**Table 24 Safety data and safety performance indicators (SPIs) database in the period 2014-2019**

Safety Performance Indicators (SPIs)	Total No. of reported hazards (occurrences)	No. of hazards – MOR	No. of hazards – VOR	No. of hazards – MoC	No. of internal changes – M.O.C	No. of regulation changes M.O.C	No. of hazards – ATO	No. of hazards – FSTD	No. of hazards – AMO	No. of hazards – CAMO	No. of conducted risk assessment & mitigations	No. of Risk Index – RED	No. of Risk Index – YELLOW	No. of Safety Review Boards (SRBs)	Number of reportable occurrences vs. number of flight hours	Flight hours
	SPI1	SPI2	SPI3	SPI4	SPI5	SPI6	SPI7	SPI8	SPI9	SPI10	SPI11	SPI12	SPI13	SPI14	SPI15	
2014	29	7	14	8	4	4	28	1	4	0	25	8	16	4	0.012	2,483.66
2015	22	2	4	16	11	5	18	2	5	2	14	4	7	4	0.017	1,260.42
2016	34	9	11	14	9	5	34	2	1	1	24	7	14	6	0.019	1,754.37
2017	21	3	5	13	10	3	20	0	2	1	13	1	12	3	0.012	1,791.17
2018	43	5	5	33	12	21	36	4	5	9	16	3	13	2	0.020	2,187.68
2019	70	4	3	64	16	48	57	7	19	18	45	3	42	2	0.030	2,350.27
<b>TARGET</b>	<b>10</b>	<b>2</b>	<b>/</b>	<b>/</b>	<b>/</b>	<b>/</b>	<b>/</b>	<b>/</b>	<b>/</b>	<b>/</b>	<b>10</b>	<b>/</b>	<b>/</b>	<b>5</b>	<b>0.002</b>	
	↓	↓	↓	↓	↓	↓	↓	↓	↓	↓	↓	↓	↓	↑	↓	

Source: Author according to (X, 2020)

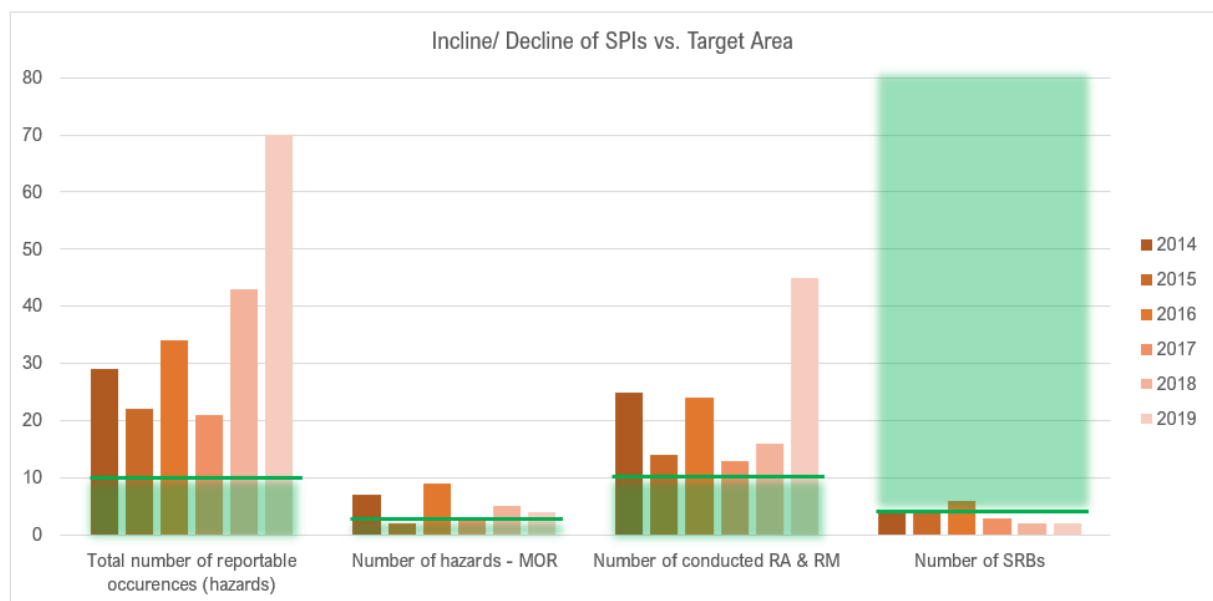
For every SPI there are 6 values joined to show safety data fluctuation for 6 years in the observed period from 2014 to 2019. The data show the general increase of values over years (except for one) which is (especially 2018 and 2019) completely opposite from the target area which requires the values to decrease (except for one – SPI14) over years as shown in Table 24. Figure 49 shows incline/ decline of SPIs (1-14) in the period from 2014 to 2019.



**Figure 49 Incline/ decline of SPIs (1-14) in the period 2014-2019**

Source: Author

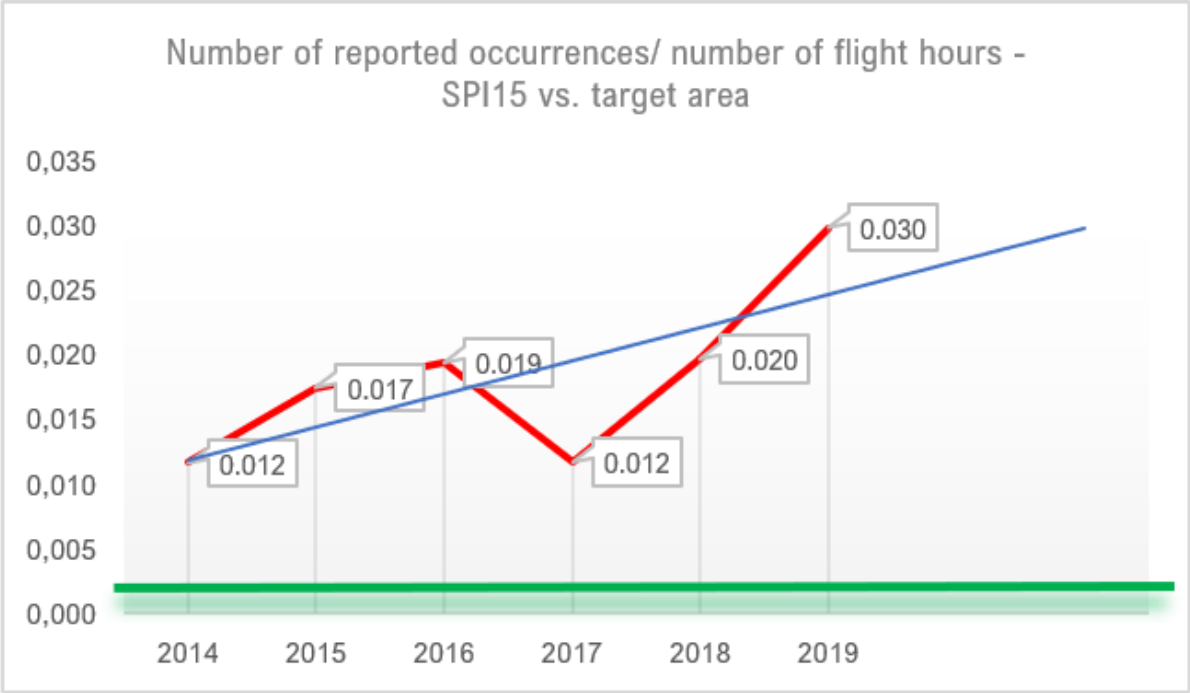
Figure 50 shows incline/ decline of SPIs (1, 2, 11 and 14) in the period from 2014 to 2019 vs. targeted area. It can be observed that only value of SPI2 in 2015 and value of SPI14 in 2016 are inside the targeted area, and all the rest cross the area which shows very negative result.



**Figure 50 Incline/ decline of SPIs (1, 2, 11 and 14) in the period 2014-2019 vs. target area**

Source: Author

Figure 51 shows incline/ decline of SPI15 in the period from 2014 to 2019 vs. targeted area. It can be observed that the SPI15 has a linear growth trend (blue line) while target area is set to 0.002 or less (green area). In 2014 and 2017 it is evident that values came very close to target area (which is a general goal of the organisation), but in 2018 and 2019 they went far away from target area.



**Figure 51 Incline/ decline of SPI15 in the period 2014-2019 vs. target area**  
*Source: Author*

Figure 52 shows incline/ decline rate of SPIs in 2017 vs. 2016, hence whichever SPI with target set to decrease/ increase shows a decrease/ increase in comparison to last year it is marked in the graph with green colour, and whichever shows opposite trend is marked in the graph with red colour. Green line shows the trend of all SPI in comparison to the last year, and it is green if the trend follows the values of targets set for each SPI. It can be observed that 2017 was recording very positive trend of safety performance in the organisation.

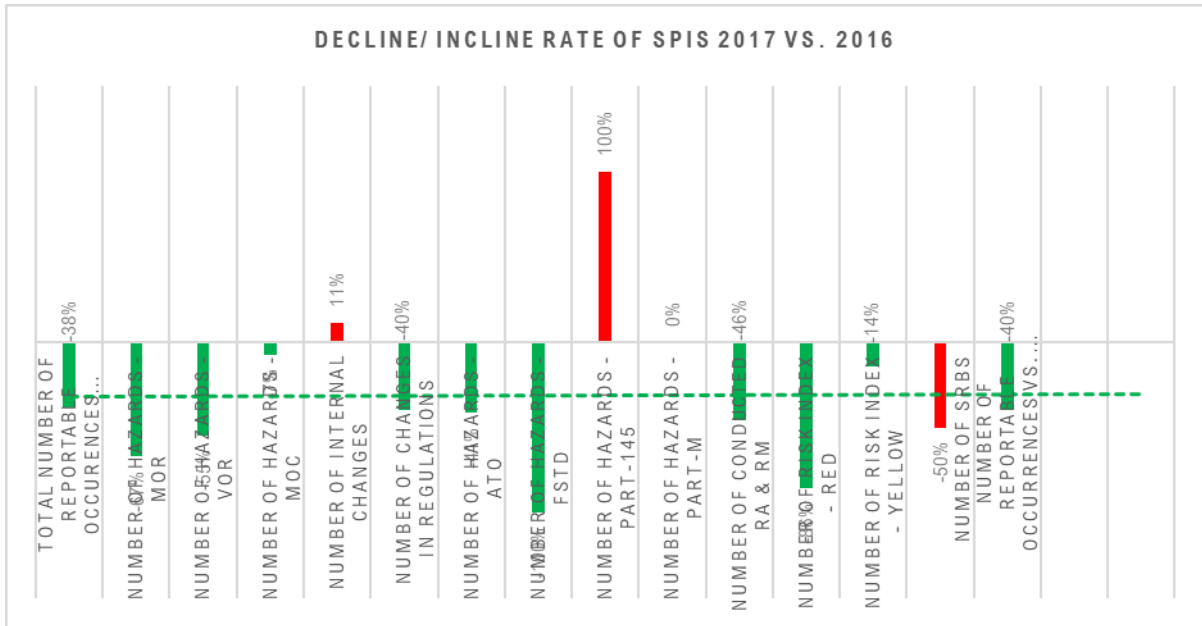


Figure 52 Incline/ decline rate of SPIs in 2017 vs. 2016

Source: Author

Figure 53 shows incline/ decline of SPIs (1, 2, 11, 14 and 15) in 2017 vs. targeted area. Red columns in the graph represent achieved values of SPIs in 2017, and green areas represent target area of the same SPIs. The red line shows trend of achieved values, and green line shows trend line of target values. The less the inclination between those lines is, the better is the safety performance of the organisation. It can be observed that the lines are very close together which shows the tendency to achieve the target values in the future. If the lines were coinciding that would mean that the target values are achieved.

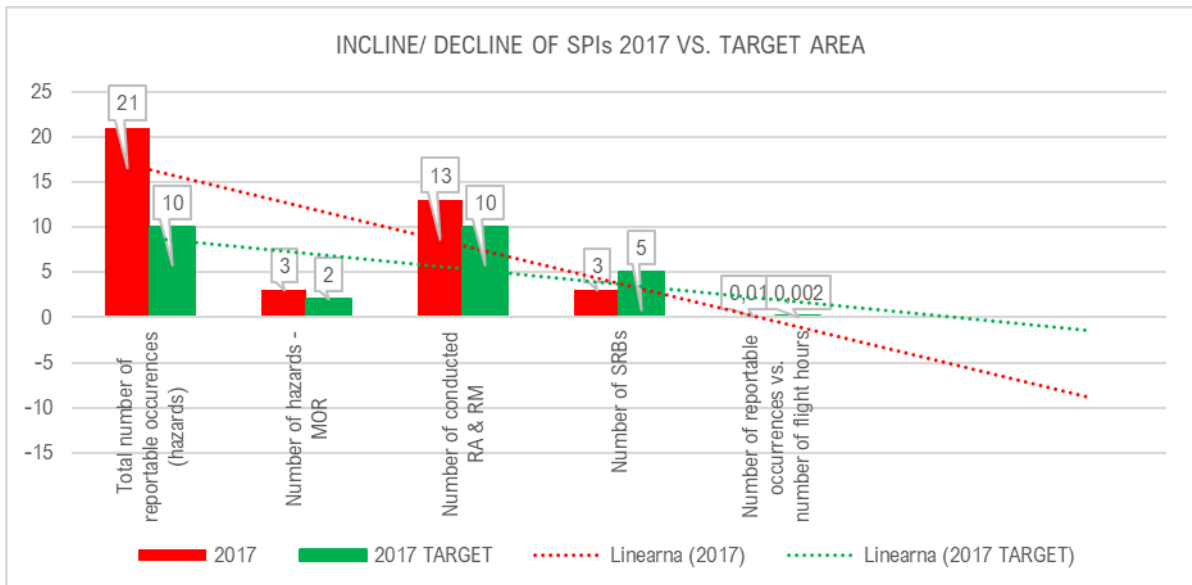
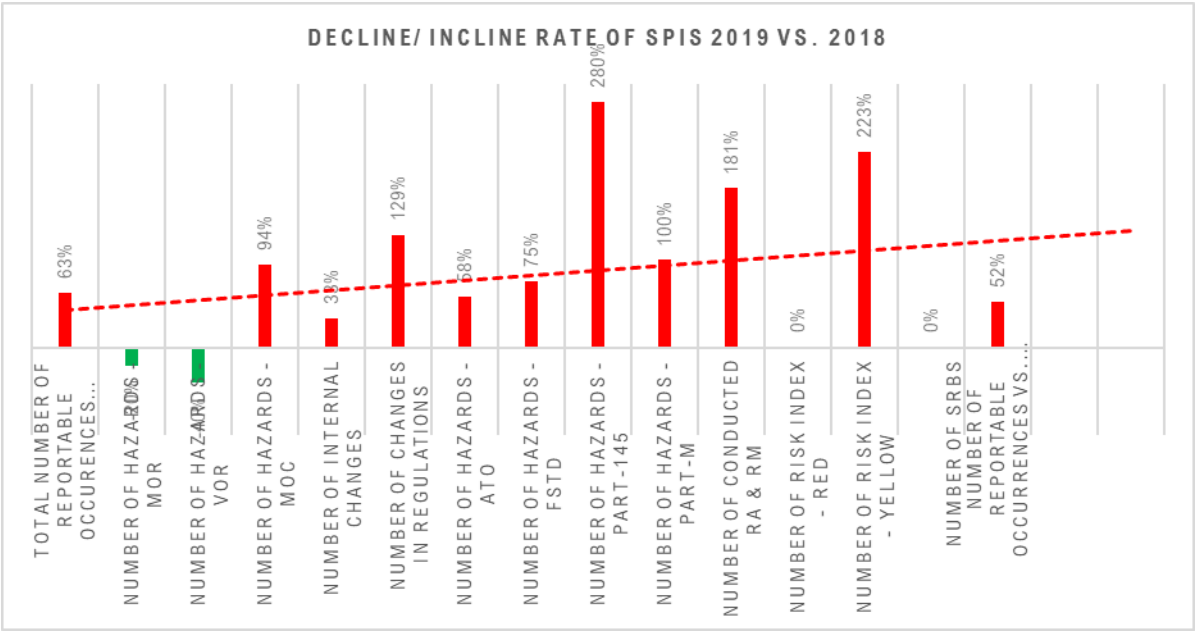


Figure 53 Incline/ decline of SPIs in 2017 vs. target area

Source: Author

Figure 54 shows incline/ decline rate of SPIs in 2019 vs. 2018, hence whichever SPI with target set to decrease/ increase shows a decrease/ increase in comparison to last year it is marked in the graph with green colour, and whichever shows opposite trend is marked in the graph with red colour. Red line shows the trend of all SPI in comparison to the last year, and it is red if the trend does not follow the values of targets set for each SPI. It can be observed that 2019 was recording very negative trend of safety performance in the organisation.



**Figure 54 Incline/ decline rate of SPIS in 2019 vs. 2018**  
 Source: Author

Figure 55 shows incline/ decline of SPIs (1, 2, 11, 14 and 15) in 2019 vs. targeted area. Red columns in the graph represent achieved values of SPIs in 2019, and green areas represent target area of the same SPIs. The red line shows trend of achieved values, and green line shows trend line of target values. The less the inclination between those lines is, the better is the safety performance of the organisation. It can be observed that the lines are very far away from each other which shows negative trend and larger deviation from targets.



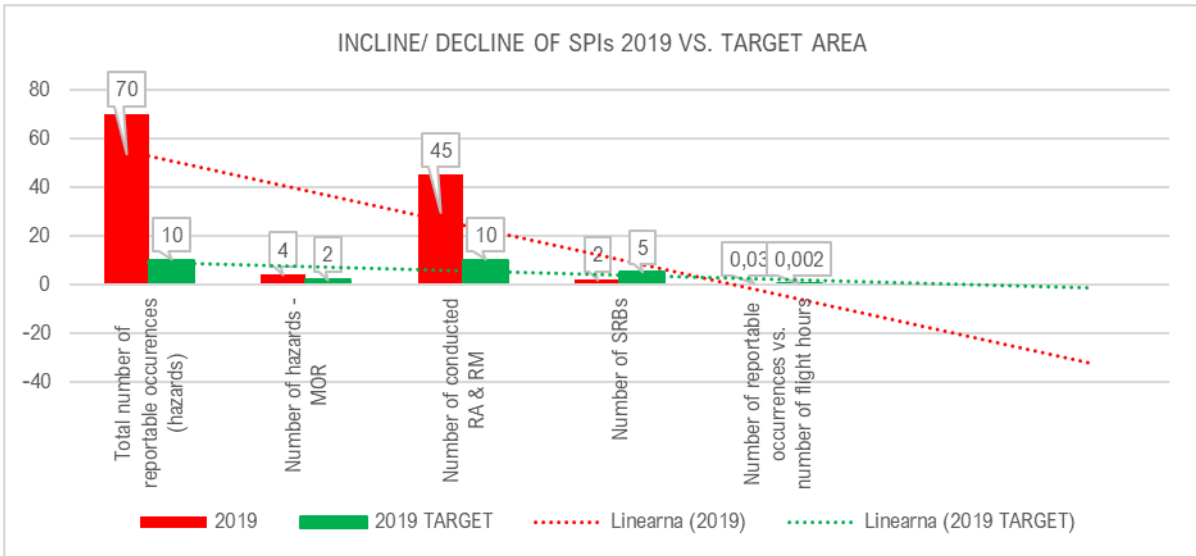


Figure 55 Incline/ decline of SPIs in 2019 vs. target area

Source: Author

5.2.2 Application of predictive methods in the safety management system of an aviation training organisation

Predictive methods that were used in this chapter are linear trend analysis and moving average (Brockwell & Davis, 2016). The safety data contains historical data of the organisation shown in Table 24. Following tables and graphs show forecasts (with presentation of both used predictive methods) to predict the behaviour of defined organisational safety performance indicators.

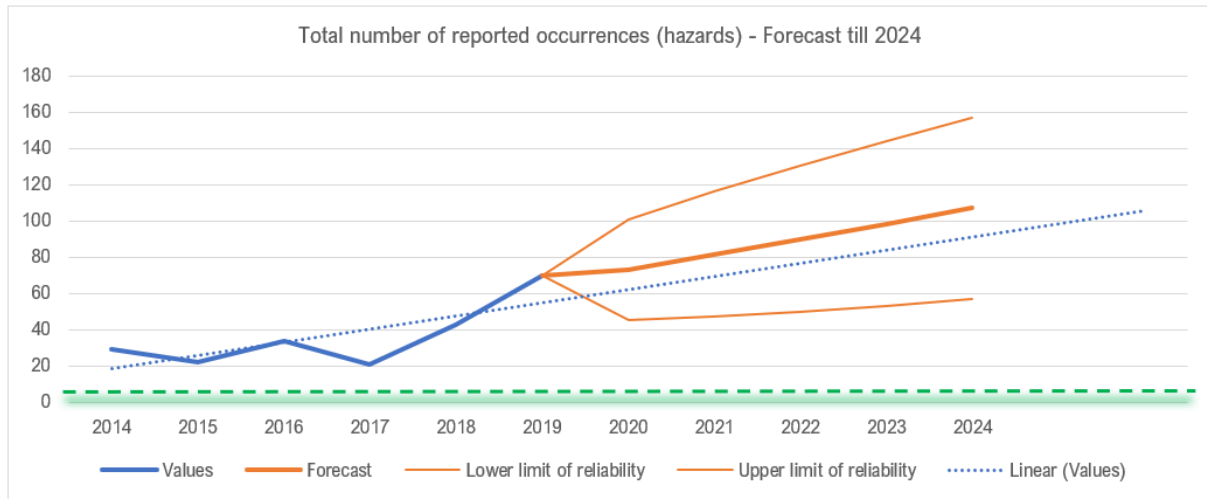
Table 25 and Figure 56 show forecast of SPI1 (total number of reported occurrences/ hazards) behaviour in the terms of incline/ decline of its values in the future period from 2020 to 2024 based on historical safety data of the organisation in the period from 2014 to 2019. The deviation from target area is also shown in the Figure (marked green). It can be concluded that the total number of hazards will continue to grow by 2024, which is very negative result given that it should continue to drop to the target area.

Table 25 Total number of reported occurrences (hazards) – Forecast till 2024

Timeline	Values	Forecast	Lower limit of reliability	Upper limit of reliability
2014	29			
2015	22			
2016	34			
2017	21			
2018	43			
2019	70	70	70	70
2020		73	46	101
2021		82	47	116
2022		90	50	130

2023	99	53	144
2024	107	57	157

Source: Author



**Figure 56 Total number of reported occurrences (hazards) – Forecast till 2024**

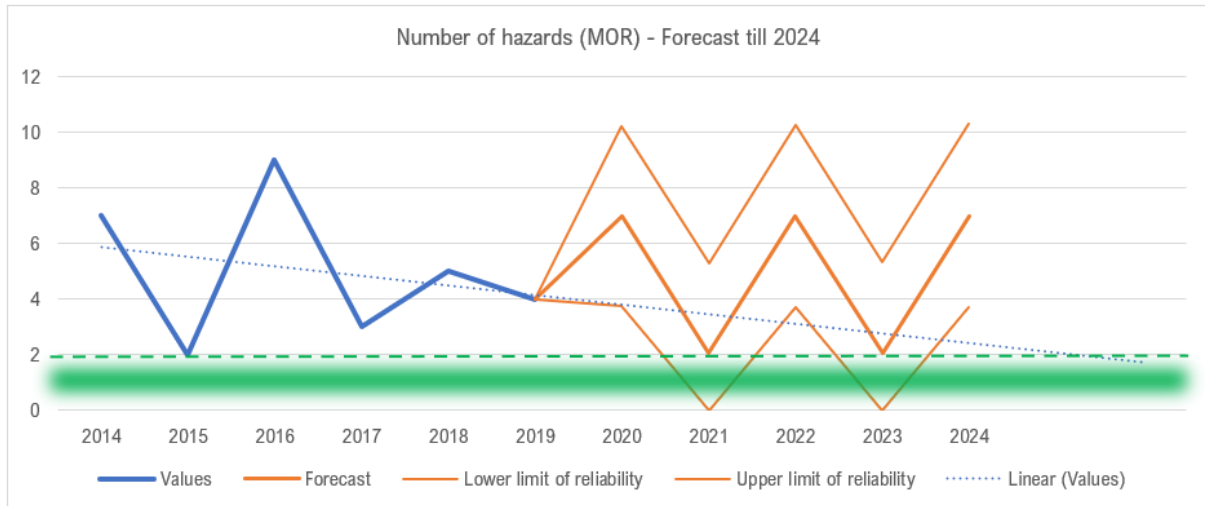
Source: Author

Table 26 and Figure 57 show forecast of SPI2 (number of reported occurrences/ hazards categorised as mandatory) behaviour in the terms of incline/ decline of its values in the future period from 2020 to 2024 based on historical safety data of the organisation in the period from 2014 to 2019. The deviation from target area is also shown in the Figure (marked green). The forecast shows that the total number of MOR hazards may stay the same or even drop by 2024, which is acceptable result given that it should continue to drop to the target area.

**Table 26 Number of hazards (MOR) – Forecast till 2024**

Timeline	Values	Forecast	Lower limit of reliability	Upper limit of reliability
2014	7			
2015	2			
2016	9			
2017	3			
2018	5			
2019	4	4	4	4
2020		7	4	10
2021		2	0	5
2022		7	4	10
2023		2	0	5
2024		7	4	10

Source: Author



**Figure 57 Number of hazards (MOR) – Forecast till 2024**

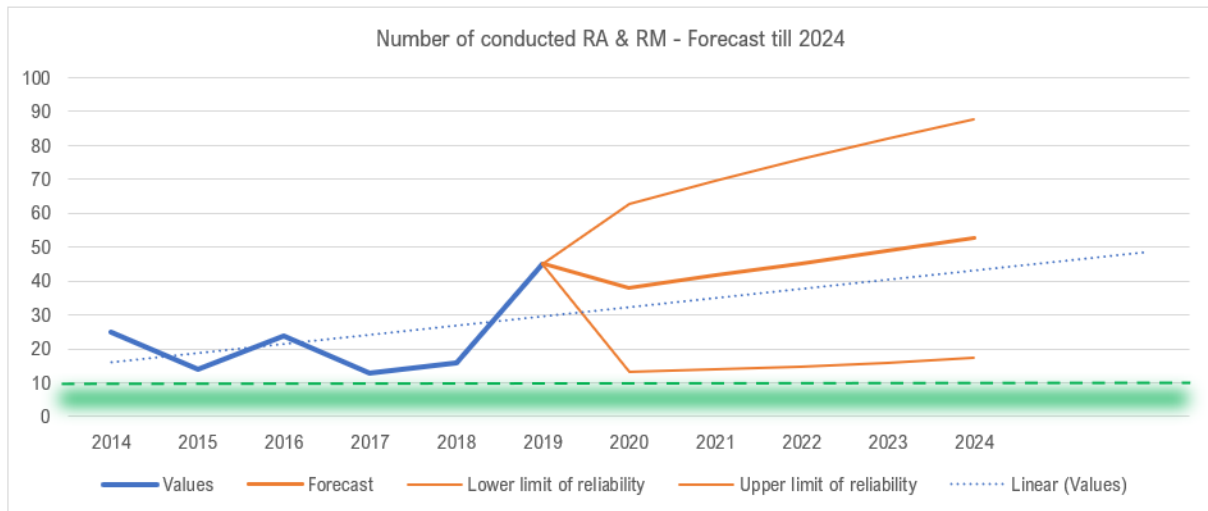
Source: Author

Table 27 and Figure 58 show forecast of SPI11 (number of conducted risk assessments & mitigations) behaviour in the terms of incline/ decline of its values in the future period from 2020 to 2024 based on historical safety data of the organisation in the period from 2014 to 2019. The deviation from target area is also shown in the Figure (marked green). It can be concluded that the total number of conducted risk assessments and mitigations will continue to grow by 2024, which is very negative result given that it should continue to drop to the target area.

**Table 27 Number of conducted risk assessments & risk mitigations – Forecast till 2024**

Timeline	Values	Forecast	Lower limit of reliability	Upper limit of reliability
2014	25			
2015	14			
2016	24			
2017	13			
2018	16			
2019	45	45	45	45
2020		38	13	63
2021		42	14	69
2022		45	15	76
2023		49	16	82
2024		53	17	88

Source: Author



**Figure 58 Number of conducted risk assessments & risk mitigations – Forecast till 2024**

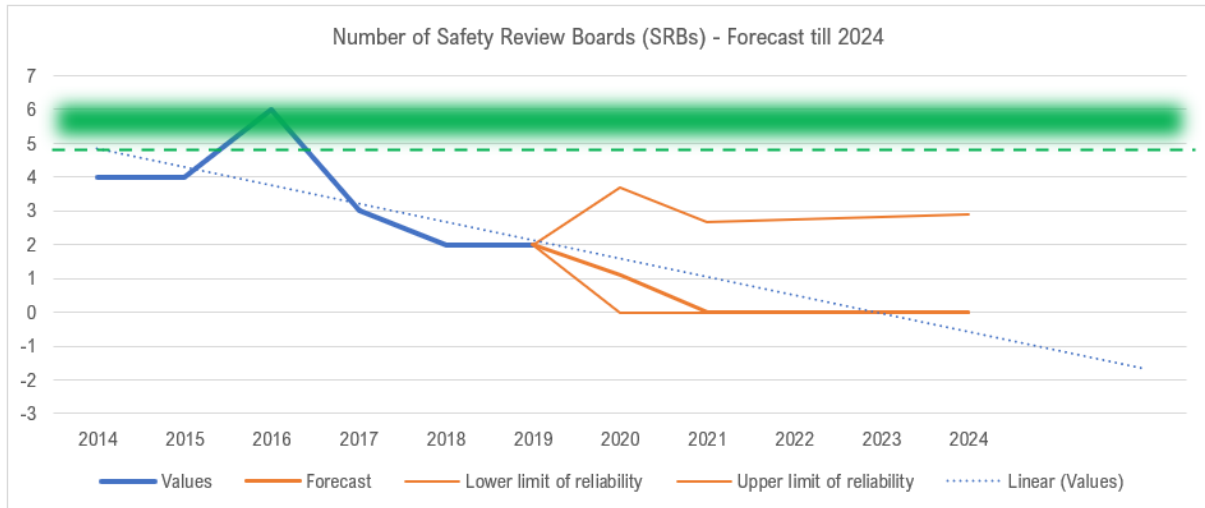
Source: Author

Table 28 and Figure 59 show forecast of SPI14 (number of conducted Safety Review Boards) behaviour in the terms of incline/ decline of its values in the future period from 2020 to 2024 based on historical safety data of the organisation in the period from 2014 to 2019. The deviation from target area is also shown in the Figure (marked green). It can be concluded that the total number of Safety Review Boards will continue to drop by 2024, which is very negative result given that it should continue to grow to the target area.

**Table 28 Number of Safety Review Boards (SRBs) – Forecast till 2024**

Timeline	Values	Forecast	Lower limit of reliability	Upper limit of reliability
2014	4			
2015	4			
2016	6			
2017	3			
2018	2			
2019	2	2	2	2
2020		1	0	4
2021		0	0	3
2022		0	0	3
2023		0	0	3
2024		0	0	3

Source: Author



**Figure 59 Number of Safety Review Boards (SRBs) – Forecast till 2024**

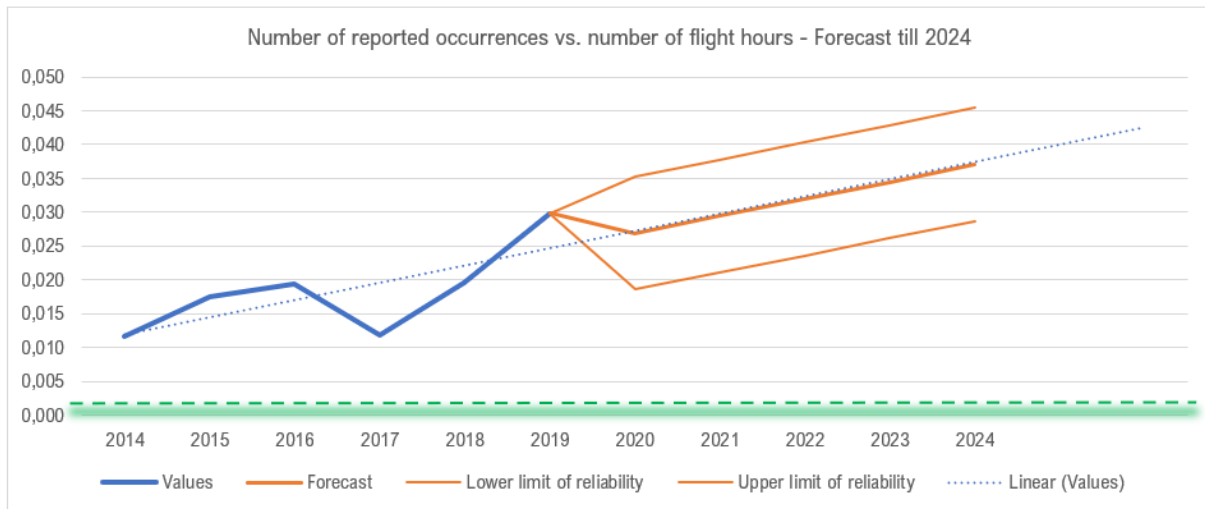
Source: Author

Table 29 and Figure 60 show forecast of SPI15 (total number of reported occurrences/ hazards vs. number of flight hours) behaviour in the terms of incline/ decline of its values in the future period from 2020 to 2024 based on historical safety data of the organisation in the period from 2014 to 2019. The deviation from target area is also shown in the Figure (marked green). It can be concluded that number of reported hazards vs. flight hours will continue to grow by 2024, which is very negative result given that it should continue to drop to the target area.

**Table 29 Number of reported occurrences vs. number of flight hours – Forecast till 2024**

Timeline	Values	Forecast	Lower limit of reliability	Upper limit of reliability
2014	0.012			
2015	0.017			
2016	0.019			
2017	0.012			
2018	0.020			
2019	0.030	0.030	0.030	0.030
2020		0.027	0.019	0.035
2021		0.029	0.021	0.038
2022		0.032	0.024	0.040
2023		0.034	0.026	0.043
2024		0.037	0.029	0.045

Source: Author



**Figure 60 Number of reported occurrences vs. number of flight hours – Forecast till 2024**

*Source: Author*

### 5.3 The liaison between reactive, proactive, and predictive safety management methodology

Studying all three methodologies, from 5.2.1 and 5.2.2, it can be observed that there are differences but also, more importantly, there are some similarities between them. All three methodologies form specific approach of managing safety issues, i.e., depending on the development of the safety management system in specific organisation, there can be reactive, proactive, or predictive safety management system. Each of the approaches has the same core steps in resolving safety issues: hazard identification, safety risk assessment and safety risk mitigation (Figure 61).

What can also be observed (Figure 61) is that each methodology of safety management is different in the step of identifying hazards. Reactive, proactive, and predictive safety management methodology all need and use input data, i.e., safety data obtained from different resources. It can also be observed that reactive methodology uses safety data from mandatory occurrence reporting. Proactive methodology uses safety data from mandatory occurrence reporting, voluntary occurrence reporting, and data obtained by measuring safety performance (SPIs and SPTs). Predictive methodology uses safety data from mandatory occurrence reporting, voluntary occurrence reporting, data obtained by measuring safety performance (SPIs and SPTs) and data obtained from predictive analyses (forecasts) that extract information from historical safety and current safety data to predict trends and behaviour patterns of emerging hazards. Safety data obtained from various resources therefore represent the liaison between three methodologies of safety management. It is also observed that proactive methodology acts as an upgrade for reactive methodology, and predictive methodology acts as an upgrade for proactive methodology (Figure 62).

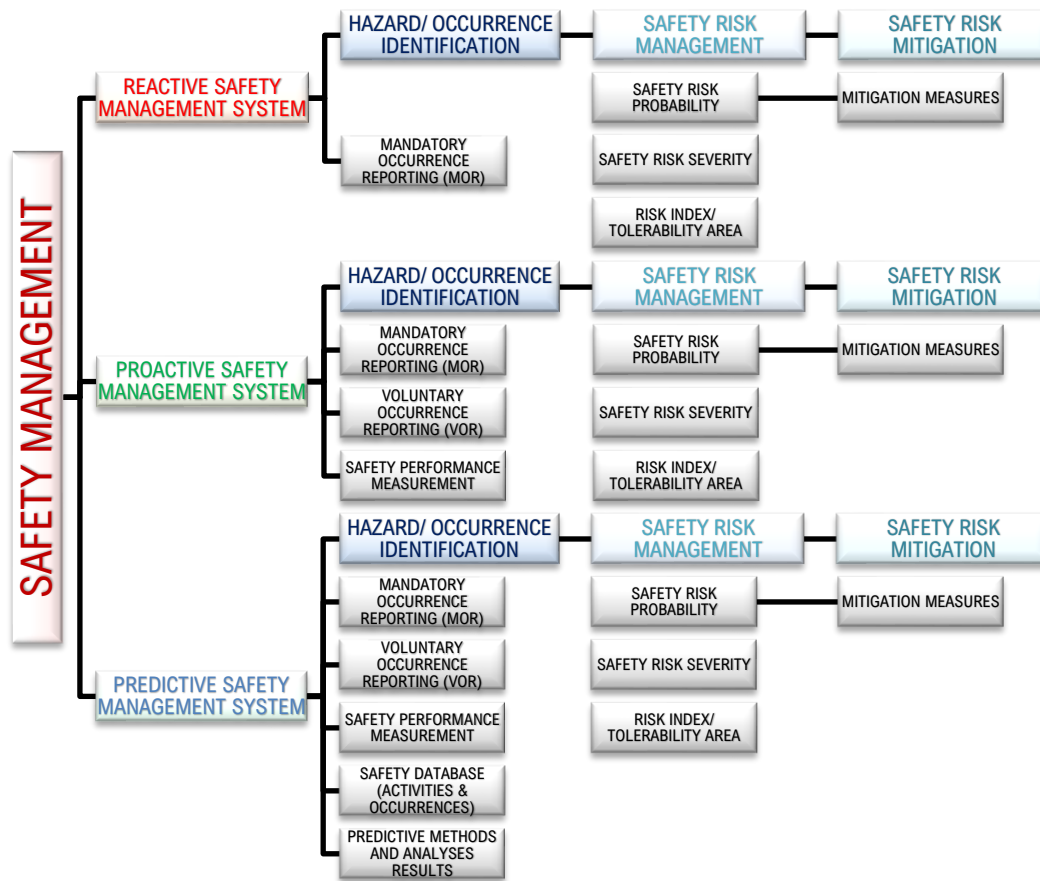


Figure 61 Overview of Safety Management System methodologies

Source: Author

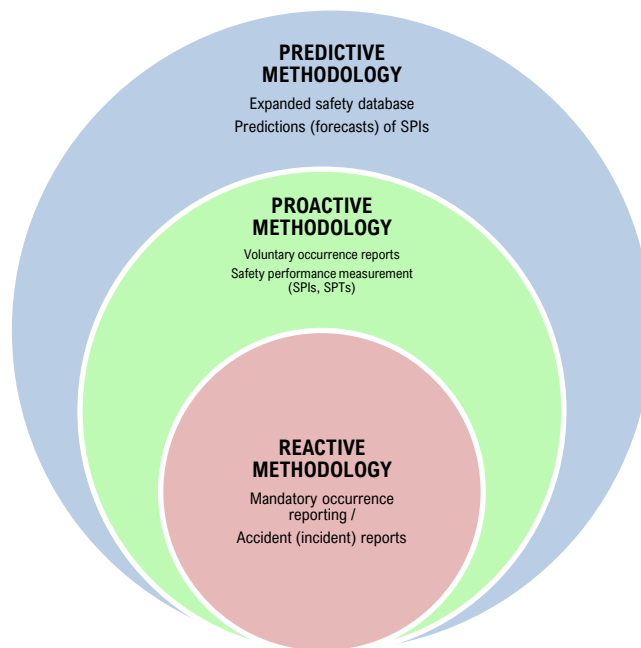


Figure 62 Liaison between Safety Management System methodologies

Source: Author

Proactive methodology gathers safety data of occurrences or organisation's process performance and analyses the gathered safety data or its frequency to estimate if a hazard could cause an accident or incident. The main mechanism for safety data collection of proactive methodology is safety reporting system. Safety data can be collected from various types of safety reports such as: accident or incident investigations, voluntary safety reporting system, management of change, continuing airworthiness reports, operational performance monitoring (flight data analyses), inspections, audits, surveys, or safety studies and reviews. The main activity of proactive safety management methodology includes defining Safety Performance Indicators (SPIs) and setting of Safety Performance Targets (SPTs).

SPIs are the parameters that give the organisation a clear view of its safety performance: where it has been; where it is now; and where it is headed, in relation to its safety performance. The set-up of SPIs should therefore be realistic, relevant, and linked to safety objectives of the organisation. Safety performance targets (SPTs) define desired achievements of safety performance in the organisation. They ensure that the organisation is on track to achieving its safety objectives and provide a measurable way of verifying the effectiveness of safety performance management activities. Both SPIs and SPTs provide clear picture of the organisation's safety performance.

Example of proactive methodology of the SMS of the pilot training organisation is outlined in 5.2.1. It is evident that the organisation is using safety reporting systems to collect necessary safety data. Organisation has also defined SPIs and SPTs for some SPIs. From the results of monitoring SPIs vs. SPTs it is evident that the safety performance has dropped over the years and that it is moving further away from SPTs, i.e., SPIs and SPTs give a solid picture of where the organisation has been; where it is now; and where it is headed, in relation to its safety performance.

Predictive methodology in general uses predictive methods to identify potential and possible hazards based on predictive analyses (forecasts) that extract information from historical safety and current safety data to predict trends and behaviour patterns of emerging hazards.

Example of predictive methodology of the SMS is outlined in 5.2.2. The historical and current safety data, SPIs and SPTs of the aviation training organisation were used as the input information to conduct predictive analysis. The obtained results show trends and behaviour patterns of established SPIs in the organisation and give improved picture of future development of safety performance in the organisation.

It can be concluded that input (safety data) from safety reporting systems is the common denominator in both proactive and predictive methodology. It represents the liaison between two methodologies. Based on collected safety data, both proactive and predictive methodology can be used to obtain information about safety performance in any organisation.

The advantage of predictive methodology is that it even acts as an upgrade for proactive methodology, as it is shown in the example in 5.2.2, where predictive methods use historical data of previously obtained SPIs and SPTs (which are defined as a part of proactive methodology) and predict the future behaviour pattern of the same SPIs.



**6 PREDICTIVE ANALYSIS OF ORGANISATIONAL AND SAFETY PERFORMANCE INDICATORS**

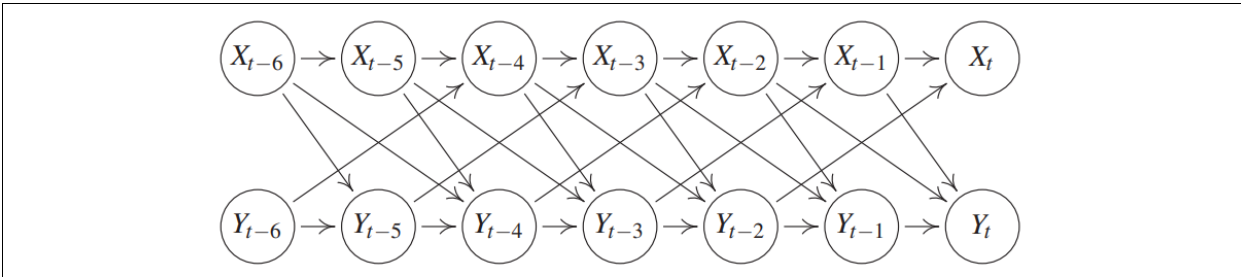
Pursuing and continuing research on development of predictive safety management methodology revealed significant insights. By using the software for statistics and predictive analytics, correlations between organisational and safety performance indicators, are made and presented in this chapter. The actual dataset of organisational and safety performance indicators of aviation training organisation was used to create cause-effect model. Using cause-effect model, specifically their relations (impacts), it can be learned which indicators (variables) should be modified to obtained desired level of safety performance target in each safety performance indicator.

**6.1 Link between causation and prediction: Theoretical overview**

6.1.1 Literature review

This chapter gives the chronological literature review of research regarding causation and prediction.

Granger causality and its variations is among the most popular approaches to causal time series analysis (Granger, 1969). Bivariate Granger Causality Theorem shows that the presence or absence of an arrow in the summary graph can be inferred by testing and the analogous statement when exchanging the roles of  $X$  and  $Y$  (Granger, 1980) (Granger, 1988). It infers that  $X$  influences  $Y$  whenever the past values of  $X$  help in predicting  $Y$  from its own past. Figure 63 shows typical scenario, in which Granger causality works: if all arrows from  $X$  to  $Y$  were missing,  $Y_t$  would be conditionally independent of the past values of  $X$ , given its own past. Therefore,  $Y_t$  depends on the past values of  $X$ , given its own past.



**Figure 63 Granger causality scenario**  
 Source: (Granger, 1980)

In 1990, Apostolakis introduced a concept of probability in safety assessments of technological systems and stated how safety assessments of technological systems require the investigation of the occurrence and consequences of rare events, and how subjectivistic (Bayesian) theory

of probability is the appropriate framework where expert opinions, which are essential to the quantification process, can be combined with experimental results and statistical observations to produce quantitative measures of the risks from such systems (Apostolakis, 1990).

Wu and others suggest the theory of evidence and the theory of possibility as possible alternatives to probability theory in safety analyses of engineering systems. Article pointed out three issues: how formal probability theory has been used to develop nonprobabilistic models; how degrees of belief are expressed in probabilistic and nonprobabilistic theories; and how the degree to which these nonprobabilistic models can be applied to system analysis in terms of their capability to combine knowledge (Wu, et al., 1990).

Senders and Moray examine the nature of human error, i.e., its causes and origins, its classifications, and the extent to which it is possible to predict and prevent errors and their impact. This book is one of the first to deal with this topic in detail, it draws into a single cohesive account contributions from experts in a range of disciplines including psychology, philosophy, and engineering (Senders & Moray, 1991).

Spirtes and others (Spirtes, et al., 2000) address questions of what assumptions and methods allow to turn observations into causal knowledge, and how can even incomplete causal knowledge be used in planning and prediction to influence and control the environment. Planning usually requires predicting the consequences of actions. Since actions change the states of affairs, assessing the consequences of actions not yet taken requires judging the truth or falsity of future conditions. If  $X$  were to be the case, then  $Y$  would be the case. Judging the effects of past practice or policy requires judging the truth or falsity of counterfactuals. If  $X$  had been the case, then  $Y$  would have been the case (Spirtes, et al., 2000). Causation is considered to be a relation between particular events: something happens and causes something else to happen. Each cause is a particular event, and each effect is a particular event. An event  $A$  can have more than one cause, none of which alone suffice to produce  $A$ . An event  $A$  can also be overdetermined: it can have more than one set of causes that suffice for  $A$  to occur (Spirtes, et al., 2000).

In 2001, Sarasvathy stated that causation rests on a logic of prediction, effectuation on the logic of control and illustrated effectuation through business examples and realistic thought experiments, with examination of its connections with existing theories and empirical evidence (Sarasvathy, 2001).

In 2002, NASA issued "Probabilistic Risk Assessment Procedures Guide for NASA Managers and Practitioners", after the Challenger accident in 1986, and once again became a strong proponent of Probabilistic Risk Assessment (PRA), strengthening its position as a powerful tool for the prediction of risk where a system or systems are highly variable (NASA, 2002). It has been determined that PRA often involves the study of rare events for which data are sparsely available, and while it provides a probabilistic alternative to deterministic point estimation of risk, PRA also has shortcomings in the context of complex, rare events such as aviation accidents (NASA, 2002).

Wolfers and Zitzewitz analysed the extent to which simple markets can be used to aggregate disperse information into efficient forecasts of uncertain future events. Carefully designed

contracts can yield insight into the market's expectations about probabilities, means and medians, and also uncertainty about these parameters (Wolfers & Zitzewitz, 2004).

In 2004, Cartwright argued that causation is not a single, monolithic concept. There are different kinds of causal relations imbedded in different kinds of systems, readily described using thick causal concepts. He stated that causal theories pick out important and useful structures that fit some familiar cases, i.e., cases discovered, and ones devised to fit (Cartwright, 2004).

Hall talks about two concepts of causation: counterfactual dependence and production (Hall, 2004). He pointed out that causation, understood as a relation between events, comes in at least two basic and fundamentally different varieties. He also dealt successfully with cases of causation by omission, which have proved stubborn counterexamples to physical process theories of causation. Hall's theory therefore appears to be a significant improvement on extant univocal theories of causation, both physical and counterfactual (Hall, 2004).

Described how people conceive of the relation between cause and effect, between action and outcome. The causal framework starts with the idea that the purpose of causal structure is to understand and predict the effects of intervention. He presented a conceptual introduction to the key mathematical ideas, presenting them in a non-technical way, focusing on the intuitions rather than the theorems. The role of causality, causal models, and intervention in the basic human cognitive functions: decision making, reasoning, judgment, categorization, inductive inference, language, and learning, is reviewed (Sloman, 2005).

Longworth described counterfactual theories of causation and Hall's theory that deals with cases of causation by omission, which have proved stubborn counterexamples to physical process theories of causation. Longworth also described cases in which our causal judgments appear to be sensitive to moral considerations, as well as the notion of responsibility (Longworth, 2006).

Roelen was among first authors to tried to explain how causal models could be used for controlling and managing aircraft accident risk and described the aviation system as a prime example of a complex multi-actor system. He stated how one of the main reasons to be interested in causation is because it allows predicting system behaviour if it is assumed that the past and present determine the future. Therefore, if observed, in the past, certain causes have certain effects that can be assumed to be the same causes that would have the same effects in the future (Roelen, 2008).

Beebe and others provided an overview of topics related to causation, as well as the history of the causation debate from the ancient Greeks to the logical empiricists. Causation is a central topic in many areas of philosophy. In metaphysics, philosophers want to know what causation is, and how it is related to laws of nature, probability, action, and freedom of will (Beebe, et al., 2009).

Lawson made basic inferences of scientific reasoning, argumentation, and discovery. The primary goal is to employ the inferences of abduction, retroduction, deduction, and induction to introduce a pattern of scientific reasoning, argumentation, and discovery that is postulated to be universal, thus can serve as an instructional framework to improve reasoning and argumentative skills (Lawson, 2009).

In 2009, Reiss stated that all univocal analyses of causation face counterexamples. An attractive response to such situation is to become a pluralist about causal relationships. He defined “Causal pluralism” as a pluralistic notion and argued about concepts of cause in the social sciences (Reiss, 2009).

Shmueli discussed how descriptive research may seem the least interesting and, as a result, the least popular of the three research goals, and it is often not even mentioned as a separate goal in addition to prediction and explanation. Although prediction is often considered an inferior goal in comparison to explanation, he stated that it should not be underestimated, both in terms of a research goal, but also in terms of how to accomplish it. He defined that prediction is concerned with being able to know outcomes that have not yet been observed (Shmueli, 2010). Shmueli also explained how statistical modelling is a powerful tool for developing and testing theories by use of causal explanation, prediction, and description. In many disciplines there is near-exclusive use of statistical modelling for causal explanation and the assumption that models with high explanatory power are inherently of high predictive power (Shmueli, 2010).

Atmanspacher & Filk addressed major distinctions between the notions of determinism, causation, and prediction, as they are typically used in the science. Key aspects of the theory of deterministically chaotic systems together with historical quotations provide significant illustrations. An important point of various discussions in consciousness studies (notably about “mental causation” and “free agency”), the alleged “causal closure of the physical”, which was analysed on the basis of the affine time group and the breakdown of its symmetries (Atmanspacher & Filk, 2012).

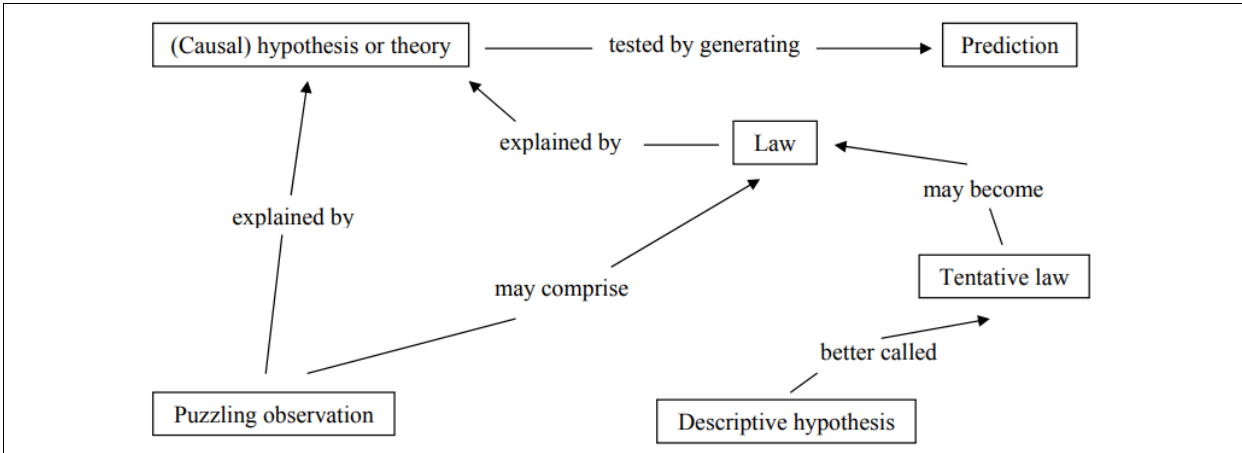
Buehner described temporal binding as a subjective shortening of elapsed time between actions and their resultant consequences. Originally, it was thought that temporal binding is specific to motor learning and arises as a consequence of either sensory adaptation or the associative principles of the forward model of motor command. Both of these interpretations assume that the binding effect is rooted in the motor system and, critically, that it is driven by intentional action planning. The research demonstrated that both intentional actions and mechanical causes result in temporal binding, which suggested that intentional action is not necessary for temporal binding and that it results from the causal relation linking actions with their consequences (Buehner, 2012).

In 2012, Reiss presented an alternative account of causation in the biomedical and social sciences according to which the meaning of causal claims is given by their inferential relations to other claims. Specifically, he argued that causal claims are typically related to certain evidential claims as well as claims about explanation, prediction, intervention and responsibility (Reiss, 2012).

Button and Yuan examined the potential role that air freight transport in the US can play in stimulating local and regional economic development. The analysis examines trends in employment and income for metropolitan statistical areas that make use of air freight services. The focus was on causality, and not on simple correlation, and uses econometric analysis rather than simpler economic multiplier approaches. Granger causality testing indicated that air freight transport was a positive driver for local economic development (Button & Yuan, 2013).

Van De Vijver and others explored the potential of heterogeneous Granger analysis in transport geography research by applying this method to a specific case of the often complex and potentially reciprocal linkages between the deployment of transport infrastructures and spatial economic development. Although conceptual and empirical linkages between both indicators can be assumed based on previous research, relatively little is known about the actual causality. Using heterogeneous Time Series Cross Section Granger causality analysis for the period 1980–2010, authors explored the presence of four “causality scenarios” amongst different country-pairs (Van De Vijver, et al., 2014).

In 2014, Eastwell defined that causal hypothesis is a proposed explanation, that prediction is the expected result of a test that is derived, by deduction, from a hypothesis or theory, that law (or rule or principle) is a statement that summarises an observed regularity or pattern in nature, and scientific theory is a set of statements that, when taken together, attempt to explain a broad class of related phenomena (Eastwell, 2014). Figure 64 shows overview of the relationship between hypotheses, predictions, laws, and theories.



**Figure 64 Overview of the relationship between hypotheses, predictions, laws, and theories**  
 Source: (Eastwell, 2014)

Peters and others explained the difference between a prediction that is made with a causal model and a non-causal model. The predictions from a causal model will in general work as well under interventions as for observational data. In contrast, predictions from a non-causal model can potentially be very wrong if we actively intervene on variables. Authors proposed to exploit the invariance of a prediction under a causal model for causal inference (Peters, et al., 2016).

Hofman and others argued how the increasingly computational nature of social science is beginning to reverse traditional bias against prediction. Historically, social scientists have sought out explanations of human and social phenomena that provide interpretable causal mechanisms, while often ignoring their predictive accuracy. They concluded that resolving three issues (better standardisation of practices for evaluating predictions, better characterisation of theoretical limits to predictive accuracy in complex social systems, and recognisable predictive accuracy

and interpretability) will lead to better, more applicable, and useful science (Hofman, et al., 2017).

To understand the importance of the key factors causing that growth in air transport, Küçükönala and Sedefoğlu aim to apply an econometric approach, i.e., Granger causality analysis. Granger causality analysis is performed in order to see whether there is a causal relationship (unidirectional or bidirectional) or not among air transport, tourism, economic growth and employment (Küçükönala & Sedefoğlu, 2017).

Based on indications in the literature, Pacheco and Fernandes explored relations between international trade-related factors and international air passenger movement in Brazil, using the Granger causality methodology. The study results showed evidence that changes in international trade indicators hold a long-term relationship with, and precede, variations in international air passenger movement (Pacheco & Fernandes, 2017).

Peters and others in 2017, summarized the results of spending a decade assaying causality. They stated that probability theory and statistics are based on the model of a random experiment or probability space  $(\Omega, F, P)$ . Here,  $\Omega$  is a set (containing all possible outcomes),  $F$  is a collection of events  $A \subseteq \Omega$ , and  $P$  is a measure assigning a probability to each event. Probability theory allows to reason about the outcomes of random experiments, given the preceding mathematical structure. They also emphasized that causal modelling starts from another, arguably more fundamental, structure. A causal structure entails a probability model, but it contains additional information not contained in a probability model. Causal reasoning denotes the process of drawing conclusions from a causal model, similar to the way probability theory allows to reason about the outcomes of random experiments. However, since causal models contain more information than probabilistic ones do, causal reasoning is more powerful than probabilistic reasoning, because causal reasoning allows us to analyse the effect of interventions or changes (Peters, et al., 2017).

Yarkoni and Westfall emphasized that fundamental problem is that model performance in a particular sample is affected by the particularities of that sample, and a selected model will almost always perform less well in a different sample, even when the new sample comes from the same dataset. A major threat in prediction is overfitting, which is almost guaranteed to happen when no specific actions are taken to avoid it (Yarkoni & Westfall, 2017).

Akinyemy examined the causal relationship between economic variables and domestic air travel demand in Nigeria. Annual data for the period 1982–2005, autoregressive distributed lag cointegration approach and Granger short-run and long-run causality tests are employed. The results indicate that short-run and long-run unidirectional Granger causality runs from GDP to air travel (Akinyemy, 2018).

In 2018, Grant and others, stated that the prediction of accidents, or systems failure, should be driven by an appropriate accident causation model. Whilst various models exist, none is yet universally accepted, but elements of different models are. They presented the findings from a review of the most frequently cited system-based accident causation models to extract a common set of systems thinking tenets that could support the prediction of accidents. The evaluation revealed that, to support accident prediction, the principles require both safe and

unsafe properties to capture the influences underpinning systematic weaknesses. The review also shows that, despite the diversity in the models there is considerable agreement regarding the core principles of system safety and accident causation. It is recommended that future research involves applying and testing the principles for the extent to which they can predict accidents in complex systems (Grant, et al., 2018).

Heinze-Deml and others stated that graphical models can represent a multivariate distribution in a convenient and accessible form as a graph. Causal models can be viewed as a special class of graphical models that represent not only the distribution of the observed system but also the distributions under external interventions. Hence, that can enable predictions under hypothetical interventions, which is important for decision making. The challenging task of learning causal models from data always relies on some underlying assumptions (Heinze-Deml, et al., 2018). Heinze-Deml and others also emphasized how important problem in many domains is to predict how a system will respond to interventions. This task is linked to estimating the system's underlying causal structure. To this end, Invariant Causal Prediction (ICP) has been proposed which learns a causal model exploiting the invariance of causal relations using data from different environments (Heinze-Deml, et al., 2018).

Furthermore, Pearl and Mackenzie point out how a widely recognized threat for causal inference is omitted variables, or confounders; such a common cause of two observed variables can lead to a spurious correlation, or a suppression of their true causal relation. They emphasized how correlation does not imply causation and discussed strategies for causal thinking (Pearl & Mackenzie, 2018).

Rohrer discussed about causal inference based on observational data, introducing graphical causal models that can provide a powerful tool for thinking more clearly about the interrelations between variables. Topics include the rationale behind the statistical control of third variables, common procedures for statistical control, and what can go wrong during their implementation (Rohrer, 2018).

Singh and others analysed the moderating effects of the multi-group in the relationship safety management system (SMS) and human factors (HF) and civil aviation safety (CAS) performance to highlight the impact of safety climate factors on the safety performance. Research used the structural equation modelling approach to explore the factors that significantly affect the CAS performance (Singh, et al., 2019).

Xu and others proposed in 2019, a novel SARIMA-SVR model to forecast statistical indicators in the aviation industry that can be used for later capacity management and planning purpose. The results of the research suggested that one of the proposed models, namely SARIMA\_SVR3, can achieve better accuracy than other methods, and prove that incorporating Gaussian White Noise is able to increase forecasting accuracy (Xu, et al., 2019).

In 2020, Krueger stated that the experimental research paradigm lies at the core of empirical psychology. New data analytical and computational tools continually enrich its methodological arsenal, while the paradigm's mission remains the testing of theoretical predictions and causal explanations. Predictions regarding experimental results necessarily point to the future. Once the data are collected, the causal inferences refer to a hypothesis now lying in the past. The

experimental paradigm is not designed to permit strong inferences about particular incidents that occurred before predictions were made (Krueger, 2020).

Researchers in ecology, evolution and behaviour (EEB) often grapple with long-term, observational datasets from which they construct models to test causal hypotheses about biological processes. Similarly, epidemiologists analyse large, complex observational datasets to understand the distribution and determinants of human health. A key difference in the analytical workflows for these two distinct areas of biology is the delineation of data analysis tasks and explicit use of causal directed acyclic graphs (DAGs). Laubach and others reviewed the most recent causal inference literature and describe an analytical workflow that has direct applications for EEB (Laubach, et al., 2021).

Etiological research aims to uncover causal effects, whilst prediction research aims to forecast an outcome with the best accuracy. Causal and prediction research usually require different methods, and yet their findings may get conflated when reported and interpreted. Ramspek and others aimed to quantify the frequency of conflation between etiological and prediction research, to discuss common underlying mistakes and provide recommendations on how to avoid these (Ramspek, et al., 2021).

#### 6.1.2 Link between causation and prediction

Every organisation has a set of conditions or resources (personnel, equipment, procedures, etc.) necessary for it to achieve its ultimate goal of conducting a business in the first place. That goal is providing service or product to users. Those conditions, i.e., organisational indicators are the first front in successfully completing the service or product to users. Any task to be completed, needs to have certain set of conditions fulfilled, otherwise it couldn't be completed. Every occurrence (adverse event) that happens is mostly related to those initially established values of organisational indicators. Any breach of that value (either if it's too low or too high, or a lack of it) will impact the outcome of the desired task to be performed. Number of external causes also affect the desired outcome (goal of the organisation), but every organisation sets its procedures initially (in manuals such as OMM, OM, SOPs, MM, etc.) in such a way that it assumes successful completion of tasks, and ultimately successfully achieved goals. Those procedures are tested and proven to be successful, otherwise, organisation wouldn't be certified to perform its services. Hence, if we assume that keeping organisational indicators and procedures in designated values that are known to produce successful outcomes, the outcomes (goals) would be achieved. This suggests that most causal factors comes from internal environment of an organisation. Using predictive analysis to predict safety performance indicators, i.e., future adverse events, we can detect in which area event is bound to occur, based on past (historical) data of an organisation. By using causal modelling, it is possible to determine causes of past events. Those same causes can be useful for mitigating the future predicted events, hence, give the possibility to react in advance, and mitigate the areas of concern (Figure 65). Link between causation and prediction is that both refer to an event that is caused by set of factors, but in different time points (past and future).



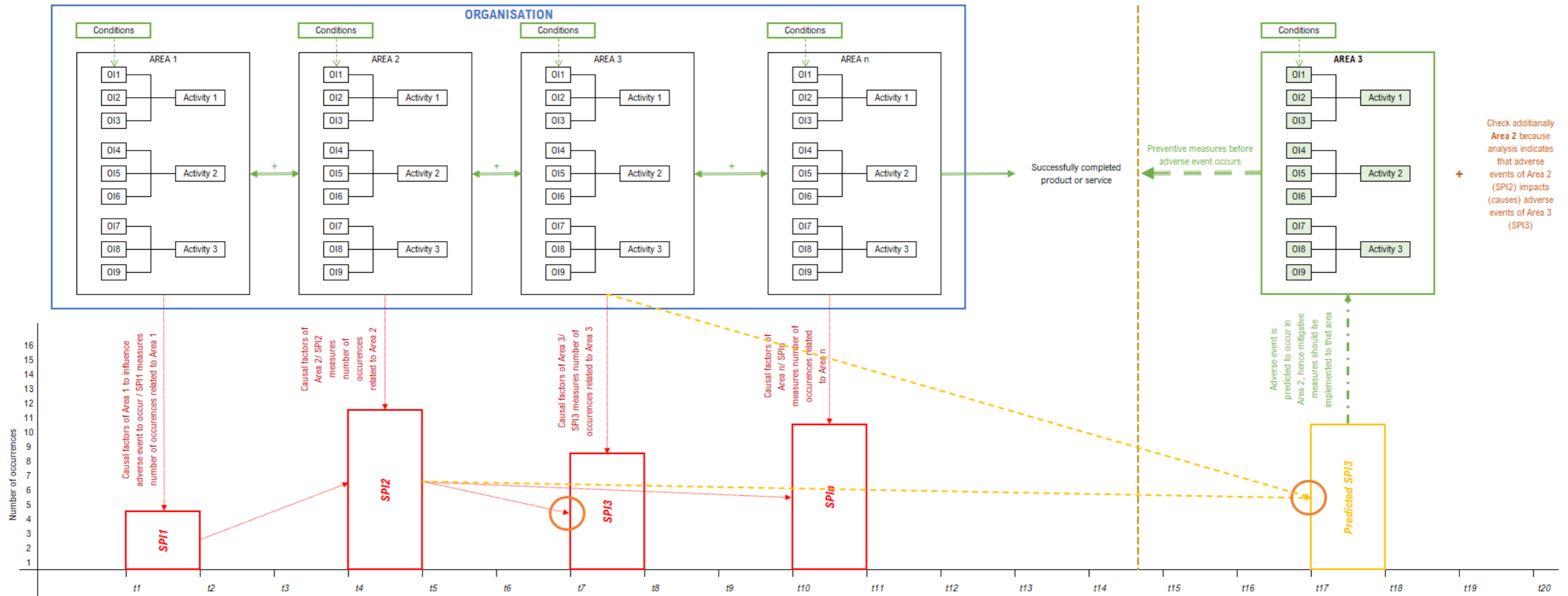


Figure 65 Link between causation and prediction  
Source: Author

## **6.2 Case study: Predictive analysis and causal modelling of organisational and safety performance indicators on the sample aviation training organisation**

IBM SPSS Statistics is the world's leading statistical software used to solve business and research problems by means of ad-hoc analysis, hypothesis testing, and predictive analytics. IBM SPSS Statistics is used to understand data, analyse trends, forecast and plan to validate assumptions and drive accurate conclusions (IBM, 2021) (Leech, et al., 2008) (Kambadur, et al., 2016) (Baksi & Parid, 2020). IBM SPSS Statistics is software that is used for research conducted in this chapter.

By using the IBM SPSS Statistics software, all data in the observed dataset is analysed, optimal forecasting models and forecasts are obtained for each safety performance indicators and cause-effect (causal) model is made presenting causal relations between all indicators in the observed dataset. Next step, after cause-effect model is made, is to examine relations between indicators, and find which impacts the ones in question. The focus is on safety performance indicators (SPIs); hence the causal model will show which of the organisational indicators (OIs) (Adjekum & Tous, 2020) and safety performance indicators (SPIs) impacts each SPI (Bartulović & Steiner, 2022).

By knowing this, it is possible to simulate increase of decrease of certain OIs and see how it effects the forecasted values of SPIs. The examples of such scenarios are shown, as well. The results show how detecting relations between data sets, in this case organisational and safety performance indicators, can help determine correlations and impacts on one another, which in turn can point to weak spots in the entire system. The examples show how increasing or decreasing values of OIs or SPIs can improve values of SPIs of the organisation, i.e., it can improve safety performance of the organisation.

### **6.2.1 Analysis of an organisation's safety database**

In this part, the aim is to establish predictive cause-effect model of defined safety performance indicators (SPIs) in order to present relations between organisational and safety performance indicators in an organisation – in this case: aviation training organisation (Bartulović & Steiner, 2022). Detecting relations between indicators indicates impacts (causes or effects) of indicators to one another, which in turn gives a possibility to improve planning of future actions with enhanced forecasting (prediction) techniques that can improve safety performance of an organisation.

A dataset of actual organisational and safety data was used. Dataset is representing crucial data and safety performance indicators of sample aviation training organisation (Y organisation), which requested to stay anonymous (Y, 2021).

The aviation training organisation (Y organisation) is an organisation that provides the services of flight crew training as its core business. Organisation is certified as the Approved Training

Organisation (ATO), as Aircraft Maintenance Organisation (AMO), Continuing Airworthiness Management Organisation (CAMO) and as Flight Simulation Training Device (FSTD) Operator. Applied safety management methodologies in Y organisation, in terms of gathering safety data, are reactive and proactive. The predictive methods of safety management are not established nor implemented in observed organisation. As a part of the Safety Assurance component, Y has established several safety performance indicators (SPIs) and set accompanying safety performance targets (SPTs). SPIs are monitored on monthly basis. The list of organisational indicators (OIs), safety performance indicators (SPIs) and safety performance targets (SPTs) of the Y's SMS are presented and in the following Table 30 (Y, 2021).

**Table 30 List of organisational and safety performance indicators in observed dataset**

<b>Mark</b>	<b>Name of an indicator</b>	<b>Target (for SPIs)</b>
O11	Flight hours (aircraft)	/
O12	Flight hours (simulator)	/
O13	Total flight hours	/
O14	Number of used aircraft	/
O15	Number of used simulators	/
O16	Number of used aircraft/ simulators	/
O17	Number of students in training on aircraft	/
O18	Number of active instructors on aircraft	/
O19	Number of students in training on simulator	/
O110	Number of active instructors on simulator	/
O111	Total number of students in training	/
O112	Total number of active instructors	/
SPI1	Total number of recorded occurrences	≤2
SPI2	Number of reported MOR occurrences	≤1
SPI3	Number of recorded changes	≤2
SPI4	Number of conducted risk assessments	≤2
SPI5	Number of detected unacceptable risks	≤1
SPI6	Number of held Safety Review Boards	≥1
SPI7	Number of conducted audits/ inspections	≥1
SPI8	Number of determined findings	≤4

*Source: Author using data of (Y, 2021)*

A dataset is composed of monthly entries for 12 organisational indicators (OIs) and 8 safety performance indicators (SPIs). The observed period is from January 2014 until March 2020. The dataset contains 75 entries. Table 31 shows a dataset of monthly organisational indicators (OIs) and safety performance indicators (SPIs) of Y organisation, in the period from January 2014 to March 2020 (Y, 2021). There are 20 defined OIs and SPIs: Flight hours (aircraft), Flight hours (simulator), Total flight hours, Number of used aircraft, Number of used simulators, Number of used aircraft and simulators, Number of students in training on aircraft, Number of active instructors on aircraft, Number of students in training on simulator, Number of active instructors on simulator, Total number of students in training, Total number of active instructors, Total number of recorded occurrences, Number of reported MOR occurrences, Number of recorded changes, Number of conducted risk assessments, Number of detected unacceptable risks, Number of held Safety Review Boards, Number of conducted audits and inspections, and Number of determined findings.

Table 31 Dataset of organisational indicators (OIs) and safety performance indicators (SPIs)

Date	OIs										SPIs									
	Flight hours (aircraft)	Flight hours (simulator)	Total flight hours	Number of used aircraft	Number of used simulators	Number of used aircraft/simulators	Number of students in training on aircraft	Number of active instructors on aircraft	Number of students in training on simulator	Number of active instructors on simulator	Total number of students in training	Total number of active instructors	SPI 1 Total number of recorded occurrences	SPI 2 Number of reported MOR occurrences	SPI 3 Number of recorded changes	SPI 4 Number of conducted risk assessments	SPI 5 Number of detected unacceptable risks	SPI 6 Number of held Safety Review Boards	SPI 7 Number of conducted audits/ inspections	SPI 8 Number of determined findings
January 2014	31.58	10.92	42.50	4	1	5	9	4	1	1	10	5	1	0	1	0	0	0	0	0
February 2014	12.42	10.50	22.92	3	1	4	5	4	2	2	7	5	0	0	0	0	0	0	0	0
March 2014	88.67	17.83	106.50	3	1	4	19	8	3	2	22	10	2	1	1	0	0	0	0	0
April 2014	63.67	0.00	63.67	5	0	5	20	7	0	0	20	7	1	0	1	0	0	0	0	0
May 2014	323.92	63.75	387.67	7	1	8	43	13	9	3	52	15	7	0	1	15	6	0	2	10
June 2014	159.17	4.50	163.67	7	1	8	29	11	3	1	32	12	0	0	0	0	0	0	1	0
July 2014	438.50	0.00	438.50	8	0	8	47	12	0	0	47	12	0	0	0	0	0	1	1	6
August 2014	612.58	0.00	612.58	8	0	8	45	10	0	0	45	10	0	0	0	0	0	0	1	2
September 2014	390.75	0.00	390.75	8	0	8	33	11	0	0	33	11	5	0	0	7	3	1	1	15
October 2014	278.33	0.00	278.33	7	0	7	35	10	0	0	35	10	1	0	0	3	0	1	1	0
November 2014	59.33	0.00	59.33	4	0	4	19	5	0	0	19	5	0	0	0	0	0	0	0	0
December 2014	24.75	0.00	24.75	3	0	3	9	4	0	0	9	4	2	0	2	14	10	1	3	6
January 2015	31.58	0.00	31.58	3	0	3	15	6	0	0	15	6	1	0	1	0	0	0	0	0
February 2015	3.83	0.00	3.83	2	0	2	3	2	0	0	3	2	0	0	0	0	0	0	0	0
March 2015	46.83	0.00	46.83	3	0	3	17	5	0	0	17	5	5	0	4	3	0	0	0	0
April 2015	50.67	0.00	50.67	5	0	5	17	6	0	0	17	6	6	0	2	10	0	2	0	0
May 2015	219.42	0.00	219.42	7	0	7	37	9	0	0	37	9	1	0	0	1	0	0	1	0
June 2015	18.08	0.00	18.08	4	0	4	9	6	0	0	9	6	0	0	0	0	0	0	2	6
July 2015	142.58	0.00	142.58	7	0	7	30	8	0	0	30	8	1	0	1	5	1	1	0	0
August 2015	168.25	181.08	349.33	6	1	7	22	7	13	3	35	8	0	0	0	0	0	0	1	4
September 2015	267.17	153.50	420.67	7	1	8	40	7	18	5	58	9	2	1	1	3	0	1	1	4
October 2015	132.42	83.67	216.08	8	1	9	34	7	18	5	52	10	1	1	0	1	1	0	0	0
November 2015	150.58	60.83	211.42	7	1	8	35	7	12	4	47	8	3	0	2	5	0	0	1	0
December 2015	29.00	16.42	45.42	4	1	5	12	6	4	4	16	8	2	0	2	0	0	0	1	9
January 2016	28.83	27.00	55.83	3	1	4	11	6	8	5	19	7	2	0	1	1	0	0	0	0
February 2016	19.75	19.00	38.75	2	1	3	5	2	4	2	9	4	1	0	1	0	0	0	2	1
March 2016	98.50	1.50	100.00	5	1	6	31	8	2	1	33	8	0	0	0	0	0	0	0	0
April 2016	154.92	18.50	173.42	5	1	6	31	11	7	3	38	11	6	3	3	5	2	1	3	7
May 2016	261.17	57.25	318.42	8	1	9	38	12	14	4	52	12	3	0	2	1	0	1	1	2
June 2016	130.53	48.67	179.20	8	1	9	33	11	11	5	44	13	4	2	1	3	0	0	2	4
July 2016	252.67	93.00	345.67	7	1	8	35	12	12	3	47	12	8	1	2	7	1	1	2	1
August 2016	282.33	91.83	374.17	7	1	8	35	14	12	4	47	15	6	1	3	3	2	0	1	1
September 2016	340.67	128.67	469.33	6	1	7	35	14	12	3	47	14	1	0	0	1	0	1	1	10
October 2016	115.00	21.25	136.25	6	1	7	23	11	9	3	32	12	3	2	1	3	1	0	2	4
November 2016	40.92	47.50	88.42	3	1	4	14	7	8	4	22	9	0	0	0	0	0	1	1	2
December 2016	29.08	0.00	29.08	4	0	4	12	7	0	0	12	7	0	0	0	0	0	1	1	0
January 2017	0.00	6.00	6.00	0	1	1	0	0	2	2	2	2	0	0	0	0	0	0	1	0
February 2017	9.08	5.50	14.58	2	1	3	4	2	5	3	9	4	0	0	0	0	0	0	3	9
March 2017	152.17	35.92	188.08	4	1	5	24	8	7	3	31	8	1	0	1	0	0	1	2	12
April 2017	80.67	55.83	136.50	5	1	6	16	8	5	3	21	9	3	0	3	3	0	0	3	12
May 2017	187.83	106.42	294.25	5	1	6	28	9	15	3	43	9	2	0	2	1	0	0	2	1
June 2017	87.00	35.67	122.67	5	1	6	28	10	8	4	36	10	1	1	0	1	0	1	2	1
July 2017	193.58	88.00	281.58	5	1	6	29	11	10	4	39	13	0	0	0	0	0	0	1	1
August 2017	292.58	35.58	328.17	5	1	6	32	9	5	3	37	9	5	1	2	3	0	0	1	1
September 2017	188.25	57.17	245.42	5	1	6	29	9	6	3	35	10	0	0	0	0	0	0	2	10

October 2017	332.25	124.33	456.58	7	1	8	59	11	32	4	91	12	6	1	4	3	1	1	3	12
November 2017	166.33	35.50	201.83	7	1	8	46	10	14	3	60	10	2	0	0	2	0	0	2	4
December 2017	94.92	48.00	142.92	7	1	8	26	7	12	5	38	8	1	0	1	0	0	0	0	0
January 2018	123.22	62.75	185.97	5	1	6	17	6	15	4	32	7	0	0	0	0	0	0	1	1
February 2018	66.33	53.17	119.50	3	1	4	12	7	14	5	26	7	1	0	1	0	0	1	3	12
March 2018	29.58	2.67	32.25	5	1	6	24	6	2	2	26	6	6	1	4	7	4	0	2	2
April 2018	145.58	22.08	167.67	5	1	6	31	8	6	5	37	10	6	1	3	5	0	0	2	5
May 2018	161.33	63.50	224.83	5	1	6	35	8	8	4	43	8	5	1	4	3	0	0	2	1
June 2018	95.92	29.55	125.47	5	1	6	23	6	6	2	29	6	3	0	1	9	4	1	2	1
July 2018	324.83	107.70	432.53	6	1	7	33	8	12	3	45	8	5	1	4	0	0	1	1	1
August 2018	467.05	43.67	510.72	6	1	7	37	9	7	4	44	9	8	0	8	1	0	0	1	0
September 2018	355.42	137.48	492.90	7	1	8	50	11	21	3	71	11	5	0	5	2	0	0	1	0
October 2018	303.67	157.93	461.60	6	1	7	44	8	21	3	65	8	1	1	0	1	1	0	2	2
November 2018	64.75	79.75	144.50	5	1	6	31	9	21	6	52	10	3	0	3	3	0	0	2	1
December 2018	50.00	62.50	112.50	5	1	6	25	8	14	6	39	10	0	0	0	0	0	0	0	0
January 2019	34.25	104.33	138.58	4	1	5	13	5	9	5	22	8	3	0	3	2	0	0	1	2
February 2019	132.08	58.92	191.00	5	1	6	35	10	14	7	49	13	16	1	12	8	0	0	3	15
March 2019	228.45	39.75	268.20	4	1	5	41	11	7	4	48	12	8	0	7	19	4	0	2	13
April 2019	206.92	43.92	250.83	5	1	6	34	8	9	3	43	9	12	0	12	6	0	1	2	6
May 2019	104.17	122.17	226.33	5	1	6	32	7	17	6	49	9	1	0	1	1	0	0	3	2
June 2019	246.08	30.42	276.50	5	1	6	31	12	4	2	35	13	3	0	3	1	0	0	2	0
July 2019	377.92	71.17	449.08	6	1	7	38	10	8	3	46	10	1	0	1	1	0	0	2	2
August 2019	312.82	62.67	375.48	6	1	7	31	13	12	4	43	14	7	2	4	12	2	0	0	0
September 2019	448.50	64.00	512.50	6	1	7	44	12	8	2	52	12	6	0	6	5	0	0	3	1
October 2019	227.83	57.25	285.08	6	1	7	44	11	12	3	56	11	8	0	8	5	0	0	3	9
November 2019	54.92	165.52	220.43	4	1	5	24	10	34	6	58	10	4	1	3	4	0	0	2	13
December 2019	85.92	93.13	179.05	4	1	5	30	8	18	5	48	11	3	0	2	5	3	1	0	0
January 2020	150.42	70.02	220.43	6	1	7	41	10	18	6	59	11	6	0	6	3	0	0	1	6
February 2020	92.42	84.70	177.12	6	1	7	29	8	15	5	44	8	1	1	0	1	0	1	2	0
March 2020	66.50	62.33	128.83	5	1	6	30	9	12	5	42	10	1	0	0	1	1	0	1	0

Source: Author according to (Y, 2021)

## 6.2.2 Analysis of organisational and safety performance indicators of an aviation training organisation using statistics methods

After gathering data, it is necessary to analyse the data. Analysis of organisational and safety performance indicators is performed by function „Descriptive statistics” of IBM SPSS Statistics software. Subfunctions „Frequencies” and „Explore” were used to obtain histograms and box plots, and to perform tests of normality. It is necessary to analyse and adjust the dataset, so the forecasting and causal modelling (which are next steps) can be performed correctly.

Table 32 shows the statistics of each indicator of observed dataset. Mean, median, standard deviation, variance, skewness, standard error of skewness, range, minimum and maximum are calculated for every indicator in the dataset.

Table 33 shows results of conducted tests of normality. Used tests of normality included Kolmogorov-Smirnov test and Shapiro-Wilk test of normality, i.e., normal distribution. Tests of normality are conducted for every indicator in the dataset.

Figure 66 shows histograms (frequencies) of all 20 indicators in the dataset. The histogram is a graphical technique for normality testing. When the graph is approximately bell-shaped and symmetric about the mean, usually it can be assumed that the data in the dataset are following normal distribution.

Figure 67 shows 20 box plots for each of 20 indicators in the dataset. Box plots are standard way of presenting data distribution: including the minimum score, lower quartile, median, upper quartile, and maximum score. Box plots divide the data into sections where each contain approximately 25% of the data in that dataset. The box plot shape will show if a statistical dataset is normally distributed or skewed. Box plots are also useful in separating and showing outliers within a dataset. An outlier is an observation that is numerically distant from the rest of the data.

It is clear that most of them follow normal distribution, and some have extreme values, or so-called outliers. Given the nature and scope of work of the sample organisation (flight crew training), the outliers are usually result of bad weather conditions, time constraints, human factors, etc.

**Table 32 Statistics of each indicator of observed dataset**

		Statistics																			
		Flight hours (aircraft)	Flight hours (simulator)	Total flight hours	Number of used aircraft	Number of used simulators	Number of used aircraft/ simulators	Number of students in training on aircraft	Number of active instructors on aircraft	Number of students in training on simulator	Number of active instructors on simulator	Total number of students in training	Total number of active instructors	SP11 Total number of recorded occurrences	SP12 Number of reported MOR occurrences	SP13 Number of recorded changes	SP14 Number of conducted risk assessments	SP15 Number of detected unacceptable risks	SP16 Number of held Safety Review Boards	SP17 Number of conducted audits/ inspections	SP18 Number of determined findings (non-compliances)
N	Valid	75	75	75	75	75	75	75	75	75	75	75	75	75	75	75	75	75	75	75	75
	Missing	0	0	0	0	0	0	0	0	0	0	0	0	0	0	0	0	0	0	0	0
	Mean	163.1998	49.9216	213.1213	5.21	0.80	6.01	27.56	8.29	8.63	2.93	36.19	9.07	2.92	0.33	1.96	2.80	0.63	0.31	1.35	3.36
	Median	132.4167	43.9167	185.9667	5.00	1.00	6.00	30.00	8.00	8.00	3.00	37.00	9.00	2.00	0.00	1.00	1.00	0.00	0.00	1.00	1.00
	Std. Deviation	131.8839 8	46.31475	150.6205 9	1.679	0.403	1.728	12.459	2.879	7.368	1.920	17.097	2.868	3.101	0.622	2.586	3.841	1.609	0.492	0.979	4.410
	Variance	17393.38 4	2145.056	22686.56 3	2.819	0.162	2.986	155.22 3	8.291	54.291	3.685	292.31 6	8.225	9.615	0.387	6.688	14.757	2.588	0.243	0.959	19.450
	Skewness	1.027	0.894	0.599	- 0.400	- 1.531	- 0.554	-0.203	-0.410	0.991	-0.162	0.134	-0.242	1.574	2.047	2.083	2.125	3.715	1.200	0.134	1.268
	Std. Error of Skewness	0.277	0.277	0.277	0.277	0.277	0.277	0.277	0.277	0.277	0.277	0.277	0.277	0.277	0.277	0.277	0.277	0.277	0.277	0.277	0.277
	Range	612.58	181.08	608.75	8	1	8	59	14	34	7	89	13	16	3	12	19	10	2	3	15
	Minimum	0.00	0.00	3.83	0	0	1	0	0	0	0	2	2	0	0	0	0	0	0	0	0
	Maximum	612.58	181.08	612.58	8	1	9	59	14	34	7	91	15	16	3	12	19	10	2	3	15

Source: Author using IBM SPSS Statistics

**Table 33 Tests of normality**

	Tests of Normality			Shapiro-Wilk		
	Kolmogorov-Smirnova					
	Statistic	df	Sig.	Statistic	df	Sig.
Flight hours (aircraft)	0.125	75	0.006	0.911	75	0.000
Flight hours (simulator)	0.141	75	0.001	0.901	75	0.000
Total flight hours	0.105	75	0.040	0.943	75	0.002
Number of used aircraft	0.156	75	0.000	0.949	75	0.005
Number of used simulators	0.490	75	0.000	0.490	75	0.000
Number of used aircraft/ simulators	0.177	75	0.000	0.945	75	0.003
Number of students in training on aircraft	0.119	75	0.010	0.978	75	0.224
Number of active instructors on aircraft	0.087	75	0.200*	0.973	75	0.112
Number of students in training on simulator	0.121	75	0.009	0.910	75	0.000
Number of active instructors on simulator	0.167	75	0.000	0.922	75	0.000
Total number of students in training	0.082	75	0.200*	0.974	75	0.130
Total number of active instructors	0.102	75	0.053	0.980	75	0.289
SPI1 Total number of recorded occurrences	0.199	75	0.000	0.831	75	0.000
SPI2 Number of reported MOR occurrences	0.437	75	0.000	0.584	75	0.000
SPI3 Number of recorded changes	0.231	75	0.000	0.744	75	0.000
SPI4 Number of conducted risk assessments	0.233	75	0.000	0.734	75	0.000
SPI5 Number of detected unacceptable risks	0.425	75	0.000	0.455	75	0.000
SPI6 Number of held Safety Review Boards	0.440	75	0.000	0.601	75	0.000
SPI7 Number of conducted audits/ inspections	0.198	75	0.000	0.877	75	0.000
SPI8 Number of determined non- compliances (findings)	0.274	75	0.000	0.763	75	0.000

\*. This is a lower bound of the true significance.

a. Lilliefors Significance Correction

Source: Author using IBM SPSS Statistics



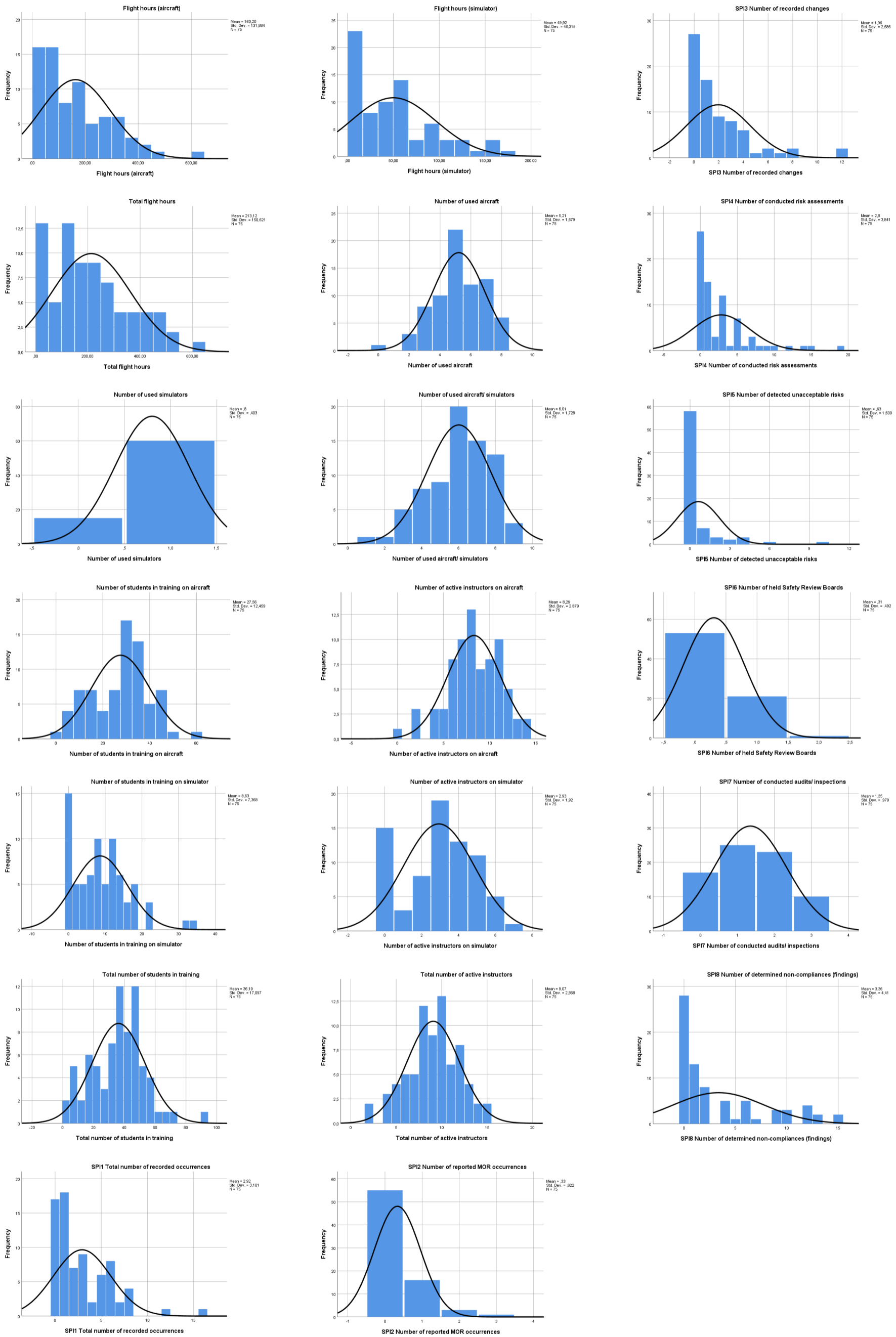
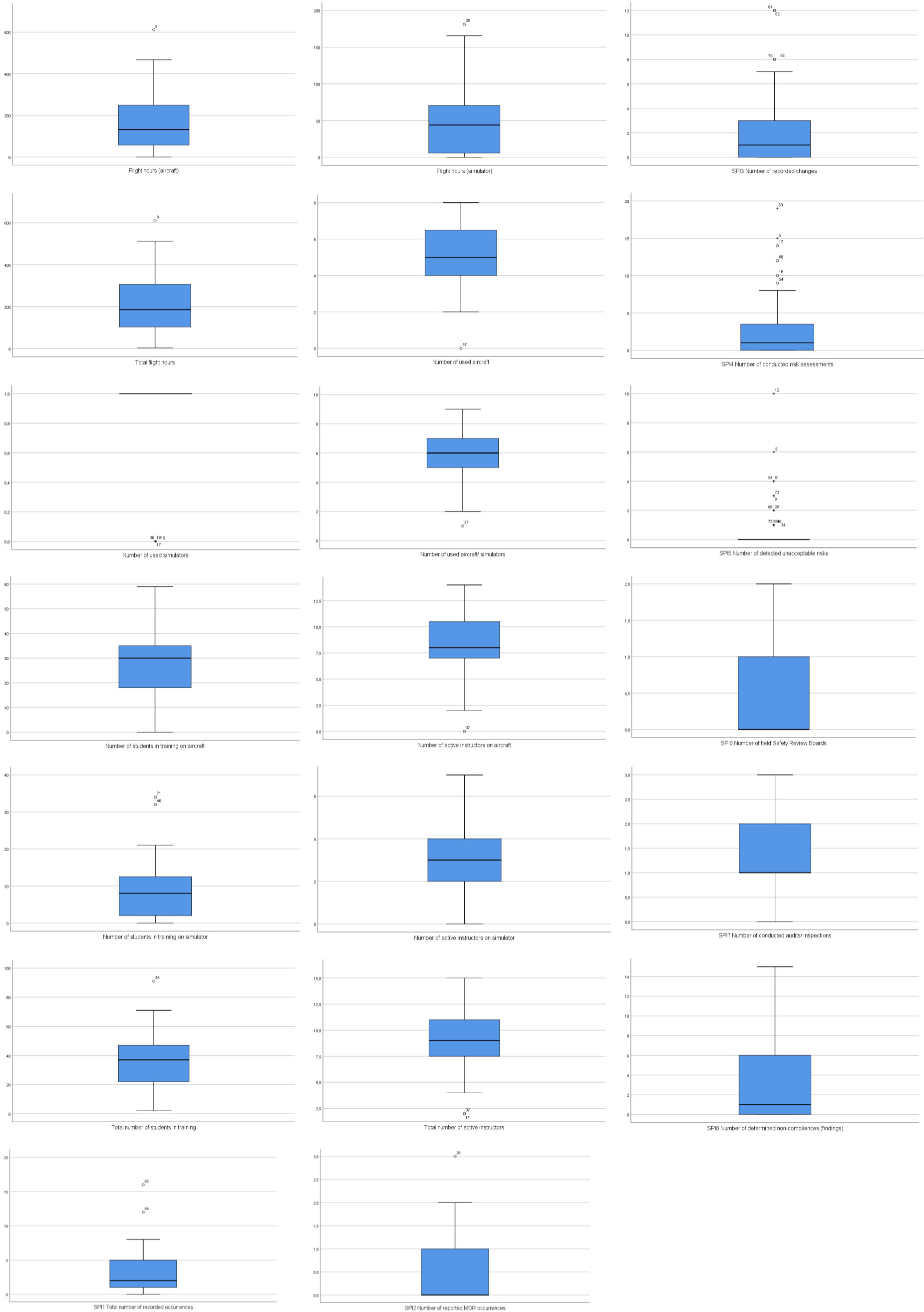


Figure 66 Histograms of organisational and safety performance indicators  
 Source: Author using IBM SPSS Statistics



**Figure 67** Box plots of each indicator  
 Source: Author using IBM SPSS Statistics

### 6.2.3 Forecasting of safety performance indicators of an aviation training organisation using predictive methods

In this part of the research, forecasts for each safety performance indicator are made, using the IBM SPSS Statistics software. Forecasting of safety performance indicators is conducted using function „Forecasting” and IBM SPSS „Expert Modeler”. This function includes a variety of applicable predictive methods such as: nonseasonal exponential smoothing (simple, Holt's linear trend, Brown's linear trend, damped trend), seasonal exponential smoothing (simple, Winter's additive, Winter's multiplicative) and ARIMA modelling. The Expert Modeler finds the optimal method to conduct the forecast, according to all given values in dataset, as well as isolating the outliers. To emphasize safety performance targets (SPTs) of each safety performance indicator (SPI), Microsoft Excel was used, as well.

Table 34 shows forecast model details for each indicator, obtained using function „Forecasting” and IBM SPSS „Expert Modeler”. Model quality for all the built models is evaluated using R-squared criterion. R-squared is coefficient of determination, and it is defined as the proportion of the variation in the dependent variable which is predictable from the independent variable or variables. There are many kinds of criteria that can be used to do the evaluation (RMSE<sup>8</sup>, RMSPE<sup>9</sup>, AIC<sup>10</sup>, BIC<sup>11</sup>, R-squared). In this case, R-squared is selected, which is the default criterion, and the larger the R-squared value, the better the model.

**Table 34 Initial forecast model description and statistics**

Model Description	Model Type	Number of outliers	Model Fit/ Stationary R-squared	SPTs
<i>SPI1 Total number of recorded occurrences</i>	ARIMA(0,0,0)(0,0,0)	3	0.531	≤2
<i>SPI2 Number of reported MOR occurrences</i>	Simple Seasonal	0	0.772	≤1
<i>SPI3 Number of recorded changes</i>	Simple Seasonal	0	0.696	≤2
<i>SPI4 Number of conducted risk assessments</i>	ARIMA(0,0,0)(0,0,0)	6	0.714	≤2
<i>SPI5 Number of detected unacceptable risks</i>	ARIMA(0,0,0)(0,0,0)	16	1.000	≤1
<i>SPI6 Number of held Safety Review Boards</i>	Simple Seasonal	0	0.792	≥1
<i>SPI7 Number of conducted audits/ inspections</i>	ARIMA(0,0,0)(1,0,0)	1	0.383	≥1
<i>SPI8 Number of determined non-compliances (findings)</i>	Simple Seasonal	0	0.618	≤4

Source: Author using IBM SPSS Statistics

<sup>8</sup> Root Mean Squared Error

<sup>9</sup> Root Mean Squared Percent Error

<sup>10</sup> Akaike Information Criterion

<sup>11</sup> Bayesian Information Criterion

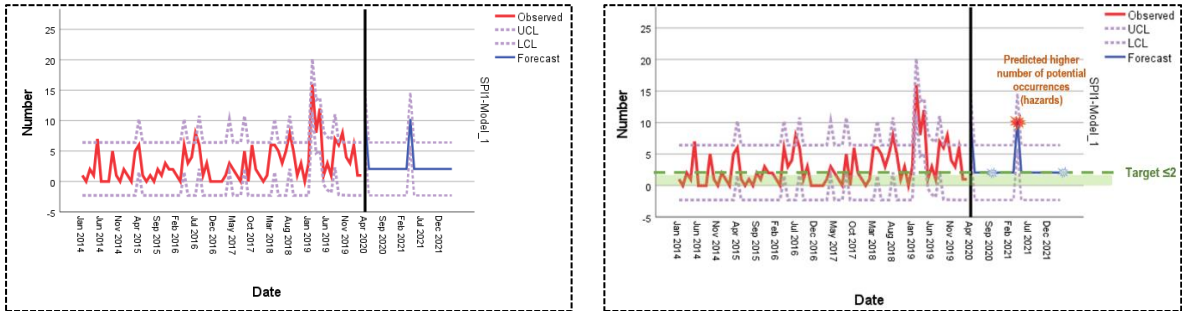
Table 35 shows the obtained forecasted values of each safety performance indicator in observed organisation. The forecast period is set up to 2 years, including March 2022.

**Table 35 Initial forecast of safety performance indicators**

Time point	SPI1	SPI2	SPI3	SPI4	SPI5	SPI6	SPI7	SPI8
Apr 2020	10	1	5	6	2	1	2	5
May 2020	2	0	3	2	0	0	2	3
Jun 2020	2	1	2	2	0	0	2	2
Jul 2020	2	0	2	2	0	1	2	2
Aug 2020	2	1	4	2	0	0	1	1
Sep 2020	2	0	3	2	0	0	2	7
Oct 2020	2	1	3	2	0	0	2	5
Nov 2020	2	0	2	2	0	0	2	3
Dec 2020	2	0	2	2	0	0	1	3
Jan 2021	2	0	3	2	0	0	1	1
Feb 2021	2	0	3	2	0	0	2	5
Mar 2021	2	0	3	2	0	0	1	4
Apr 2021	10	1	5	6	2	1	2	5
May 2021	2	0	3	2	0	0	2	3
Jun 2021	2	1	2	2	0	0	2	2
Jul 2021	2	0	2	2	0	1	2	2
Aug 2021	2	1	4	2	0	0	1	1
Sep 2021	2	0	3	2	0	0	2	7
Oct 2021	2	1	3	2	0	0	2	5
Nov 2021	2	0	2	2	0	0	2	3
Dec 2021	2	0	2	2	0	0	1	3
Jan 2022	2	0	3	2	0	0	2	1
Feb 2022	2	0	3	2	0	0	2	5
Mar 2022	2	0	3	2	0	0	2	4

Source: Author using IBM SPSS Statistics

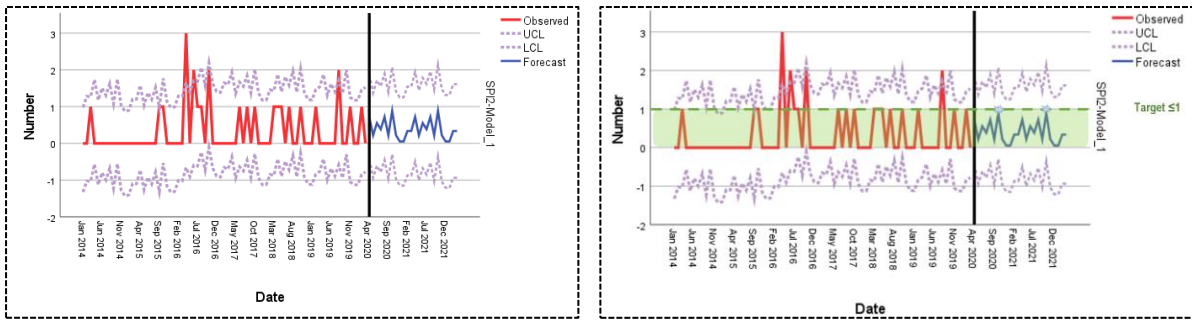
Figure 68 shows predicted values of safety performance indicator SPI1, i.e., it is evident that higher number of potential occurrences (hazards) is anticipated in nearer future.



**Figure 68 Initial forecast of safety performance indicators SPI1 – Total number of recorded occurrences for the period April 2020 – March 2022**

Source: Author using IBM SPSS Statistics and Microsoft Excel

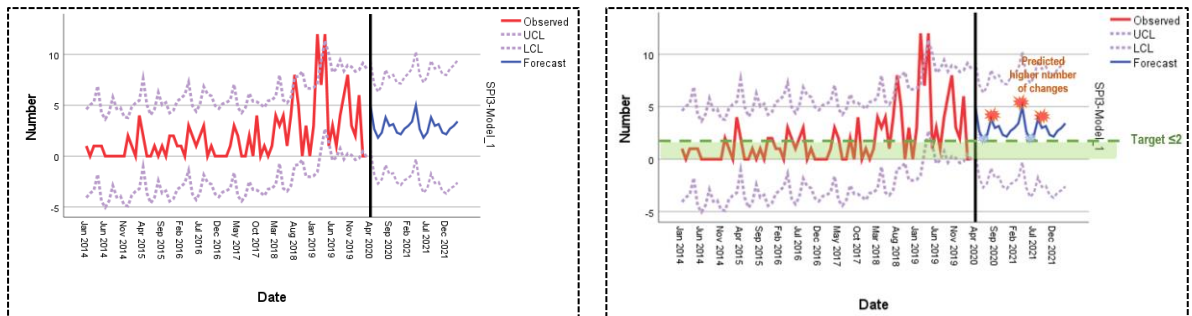
Figure 69 shows predicted values of safety performance indicator SPI2 (number of mandatory occurrences), i.e., it is evident that all the values are in target area, which shows a positive trend of SPI2 in observed future time period.



**Figure 69 Initial forecast of safety performance indicators SPI2 – Number of reported MOR occurrences for the period April 2020 – March 2022**

*Source: Author using IBM SPSS Statistics and Microsoft Excel*

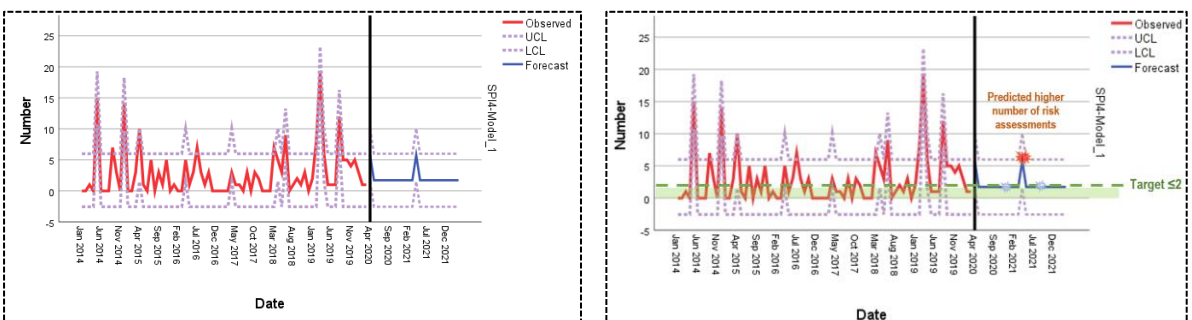
Figure 70 shows predicted values of safety performance indicator SPI3, i.e., higher number of changes is anticipated in nearer future.



**Figure 70 Initial forecast of safety performance indicators SPI3 – Number of recorded changes for the period April 2020 – March 2022**

*Source: Author using IBM SPSS Statistics and Microsoft Excel*

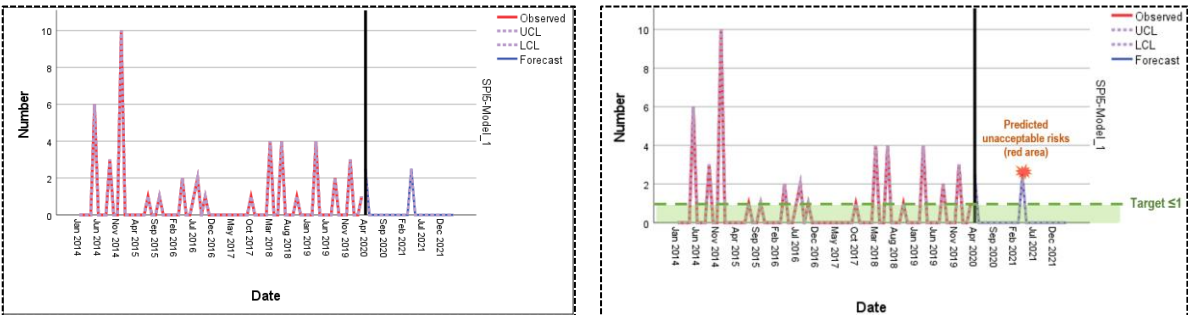
Figure 71 shows predicted values of safety performance indicator SPI4, i.e., higher number of conducted risks assessments is anticipated in the future, which also coincides with results of predicted safety performance indicator SPI1, i.e., higher number of potential occurrences (hazards).



**Figure 71 Initial forecast of safety performance indicators SPI4 – Number of conducted risk assessments for the period April 2020 – March 2022**

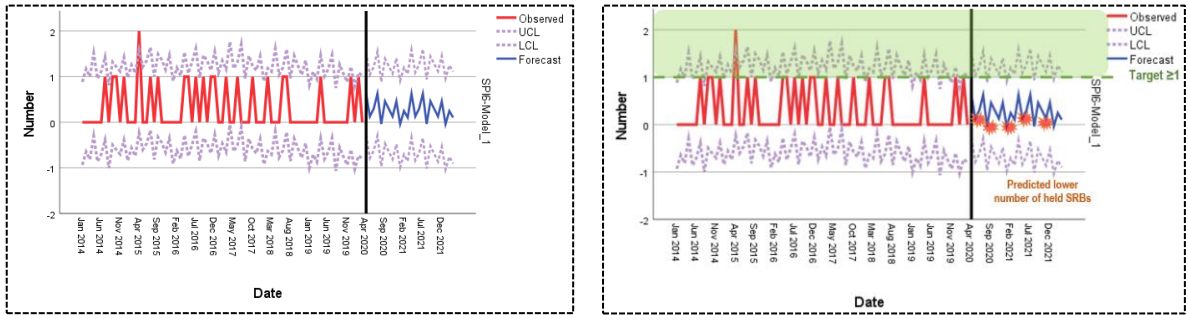
*Source: Author using IBM SPSS Statistics and Microsoft Excel*

Figure 72 shows predicted values of safety performance indicator SPI5, i.e., higher number of unacceptable risks (red area in safety risk matrix) is anticipated in nearer future, which as well, coincides with results of predicted safety performance indicator SPI1, higher number of potential occurrences (hazards) and SPI4, higher number of conducted risks assessments. Another important observation can be made as well, all three mentioned SPIs with higher predicted values, also coincide in predicted time point, i.e., all three are predicted to have higher values at approximately same time in the future. Hence, even without using causal modelling to establish impact relations between indicators, it is evident from their forecasts which indicators are closely linked together and have influence on each other.



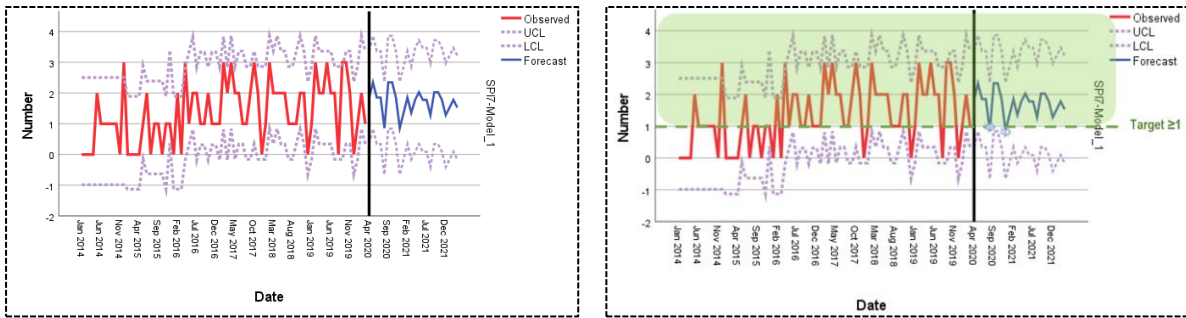
**Figure 72 Initial forecast of safety performance indicators SPI5 – Number of detected unacceptable risks for the period April 2020 – March 2022**  
 Source: Author using IBM SPSS Statistics and Microsoft Excel

Figure 73 shows predicted values of safety performance indicator SPI6, i.e., lower number of held safety meetings is anticipated in nearer future, according to historical trend.



**Figure 73 Initial forecast of safety performance indicators SPI6 – Number of held Safety Review Boards for the period April 2020 – March 2022**  
 Source: Author using IBM SPSS Statistics and Microsoft Excel

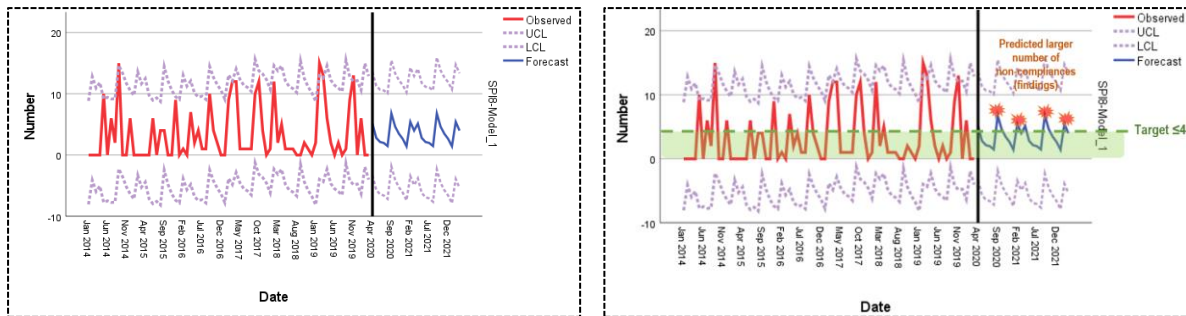
Figure 74 shows predicted values of safety performance indicator SPI7 (number of conducted audits/ inspections), i.e., it is evident that all the values are in target area, which shows a positive trend of SPI7 in observed future time period.



**Figure 74 Initial forecast of safety performance indicators SPI7 – Number of conducted audits/ inspections for the period April 2020 – March 2022**

*Source: Author using IBM SPSS Statistics and Microsoft Excel*

Figure 75 shows predicted values of safety performance indicator SPI8, i.e., higher number of non-compliances (findings) is anticipated in nearer future.



**Figure 75 Initial forecast of safety performance indicators SPI8 – Number of determined non-compliances (findings) for the period April 2020 – March 2022**

*Source: Author using IBM SPSS Statistics and Microsoft Excel*

#### 6.2.4 Causal modelling of organisational and safety performance indicators of an aviation training organisation

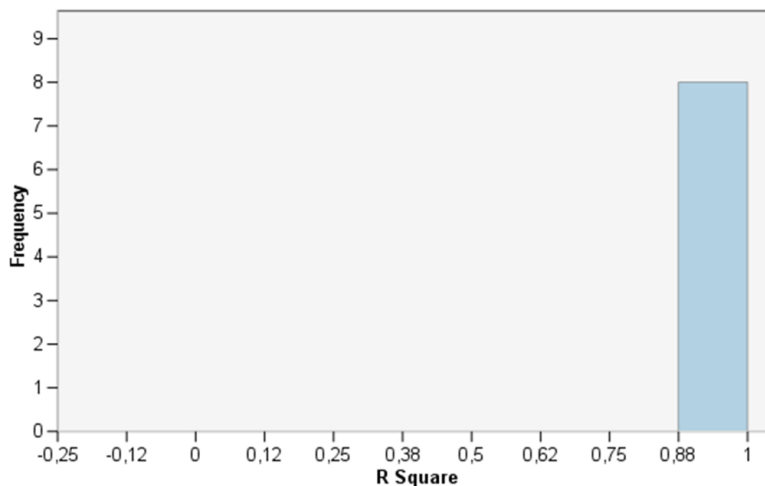
To obtain impact relations between organisational and safety performance indicators, IBM SPSS function „Temporal Causal Modelling” was used. The set-up was made in such way that independent variables are organisational indicators (OIs), i.e., OIs are set to be „inputs” in temporal causal model, and safety performance indicators (SPIs) are dependent and independent variables, i.e., SPIs are set to be „both inputs and targets”. Table 36 shows fit statistics for top causal models generated for each of eight safety performance indicators.

**Table 36 Fit statistics for top causal models**

Target Model	Model Quality				
	RMSE	RMSPE	AIC	BIC	R-squared
SPI1	0.28	0.05	-202.24	-65.09	0.98
SPI2	0.58	0.14	-99.05	38.11	0.95
SPI3	2.24	0.30	91.08	228.24	0.95
SPI4	0.99	0.15	-22.63	114.53	0.94
SPI5	2.31	0.39	95.51	232.67	0.93
SPI6	1.96	0.32	72.63	209.79	0.93
SPI7	3.27	0.57	144.38	281.53	0.93
SPI8	0.39	0.09	-151.72	-14.56	0.92

Source: Author using IBM SPSS Statistics

The Figure 76 shows „Overall Model Quality” which shows the distribution of model quality for all the built models (from Table 31). There are many kinds of criteria that can be used to do the evaluation (RMSE, RMSPE, AIC, BIC, R-squared). In this case, R-squared is selected, which is the default criterion, and the larger the R-squared value, the better the model. From the Figure 74, the built models show excellent quality because 100% of the models have R-squared values in the interval [0.88, 1].

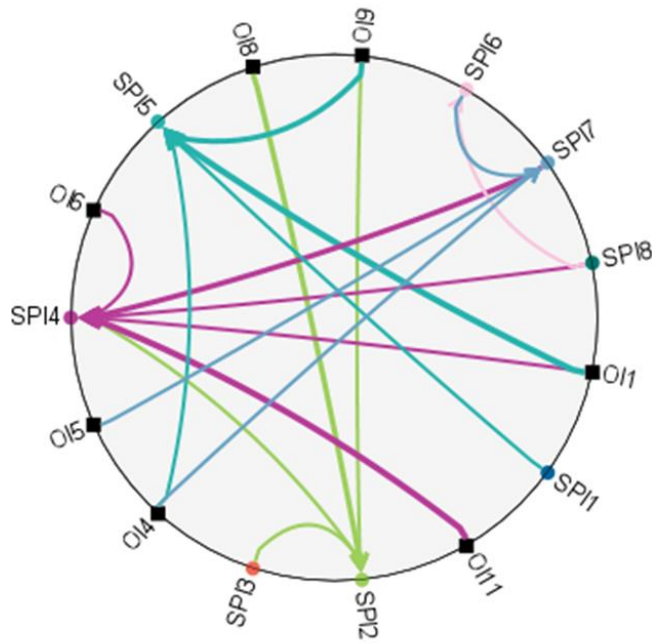


**Figure 76 Overall quality of cause-effect model**

Source: Author using IBM SPSS Statistics

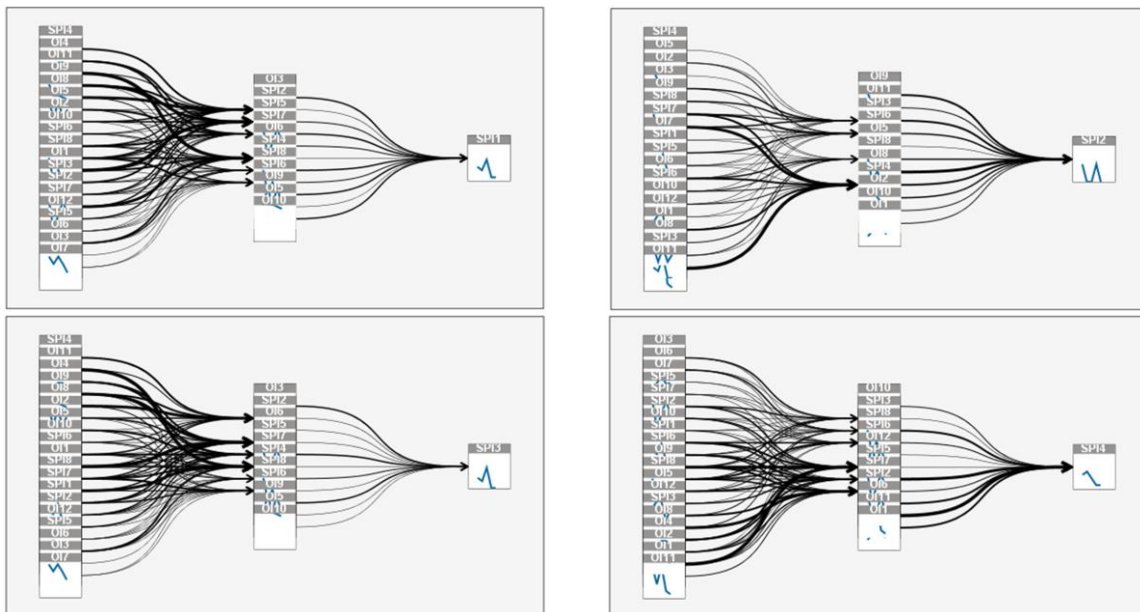
Figure 77 shows cause-effect (causal) model of organisational indicators (OIs) and safety performance indicators (SPIs).

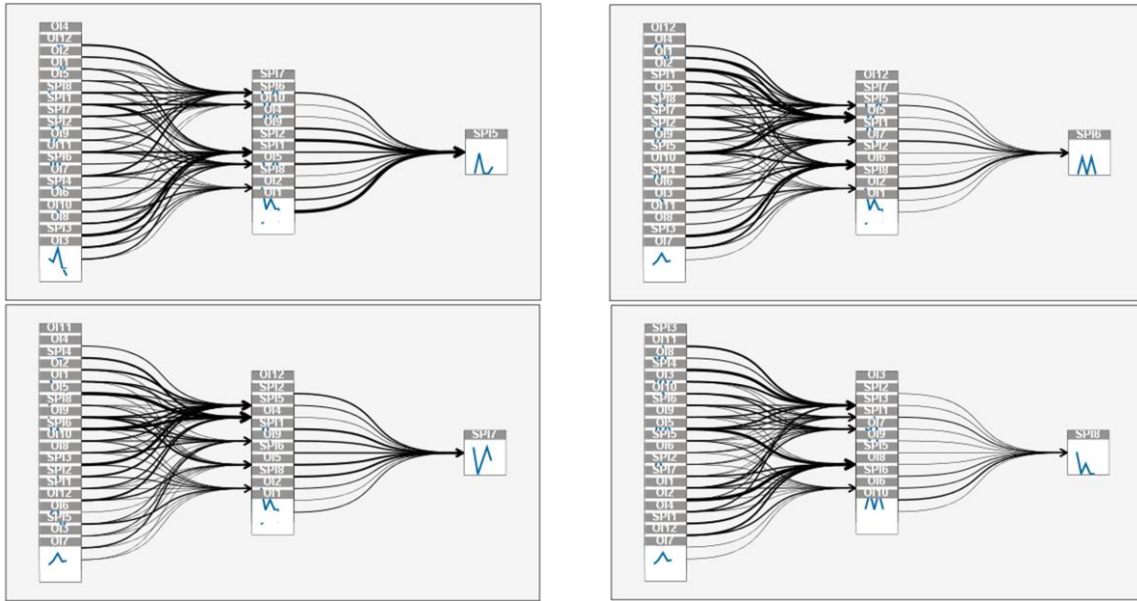




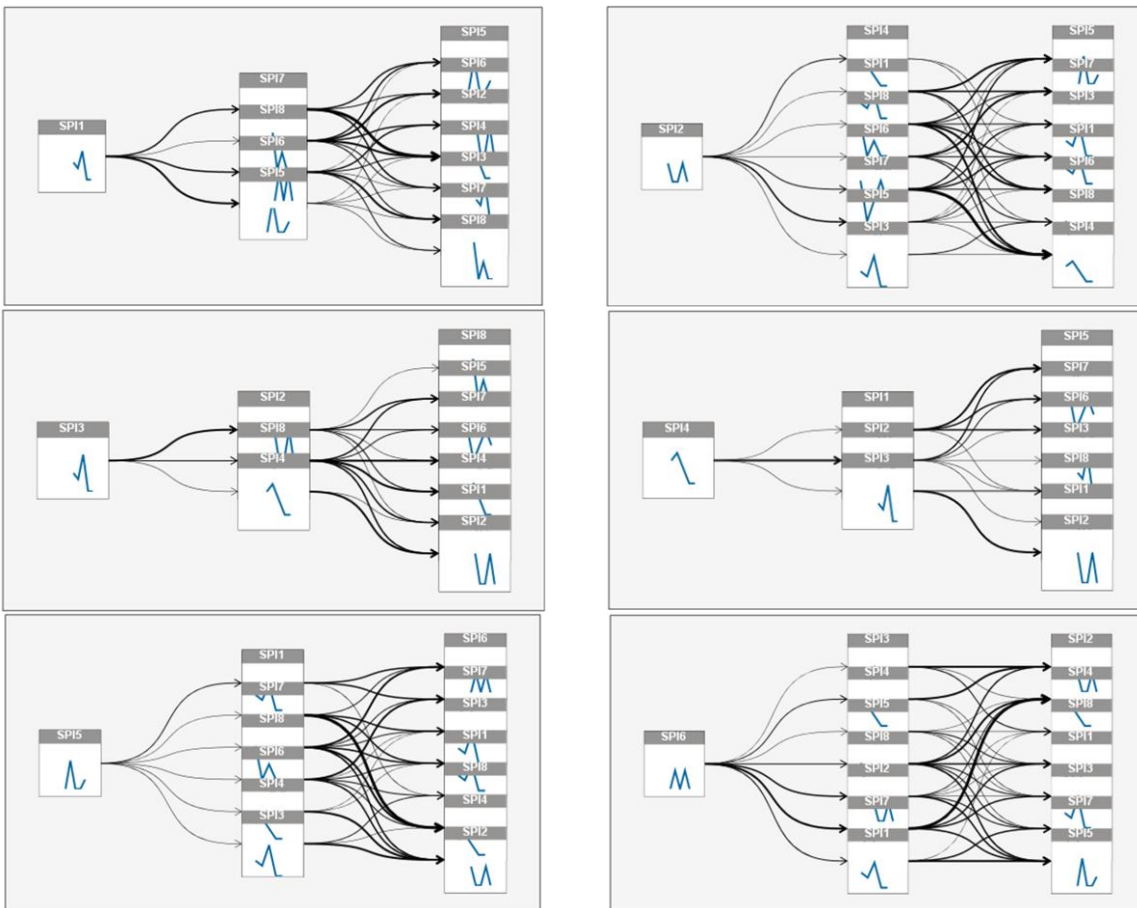
**Figure 77 Cause-effect model of individual organisational and safety performance indicators relations**  
*Source: Author using IBM SPSS Statistics*

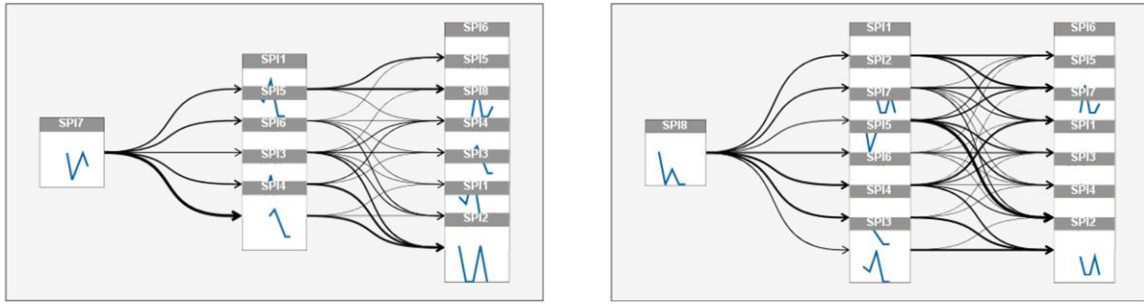
Next step, after cause-effect (causal) model is made, is to examine relations between indicators, and find which impacts the ones in question, hence the causal model shows which of the OIs and SPIs impacts safety performance indicators (SPIs). Figure 78 shows impact diagram of all causes and Figure 79 shows impact diagram of all effects of each indicator. Figure 80 shows top inputs for each observed safety performance indicator.



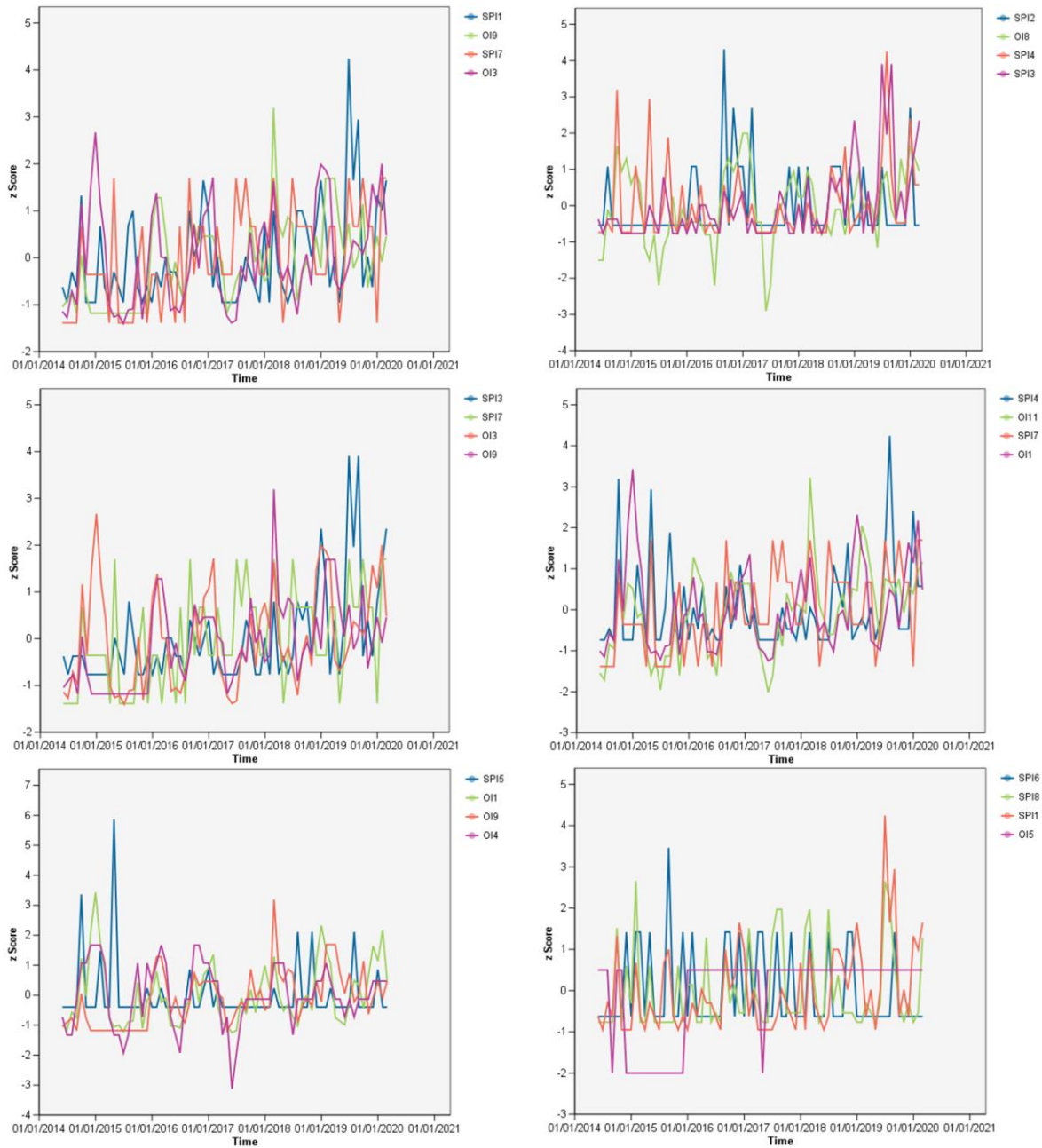


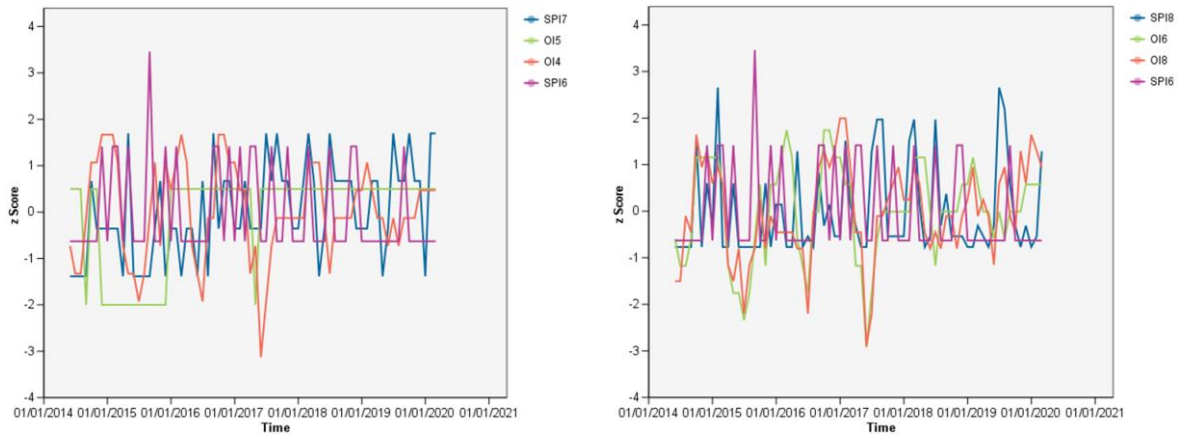
**Figure 78 Impact diagrams – causes**  
 Source: Author using IBM SPSS Statistics





**Figure 79 Impact diagrams – effects**  
*Source: Author using IBM SPSS Statistics*

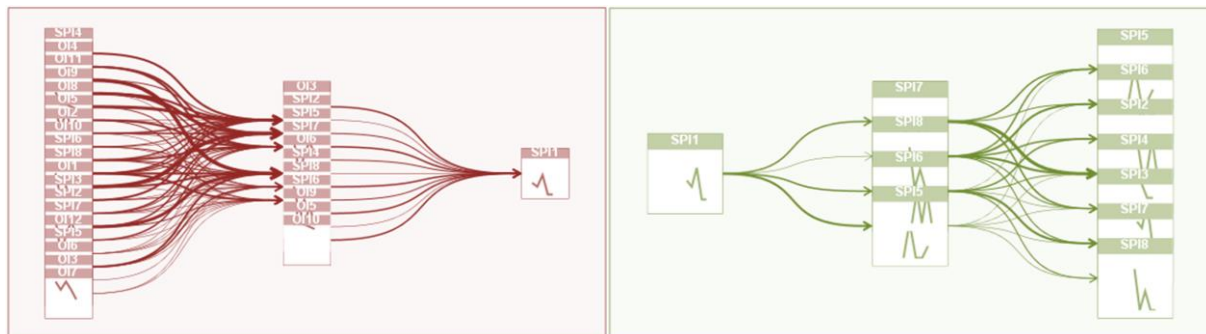




**Figure 80 Top inputs for each safety performance indicator**

*Source: Author using IBM SPSS Statistics*

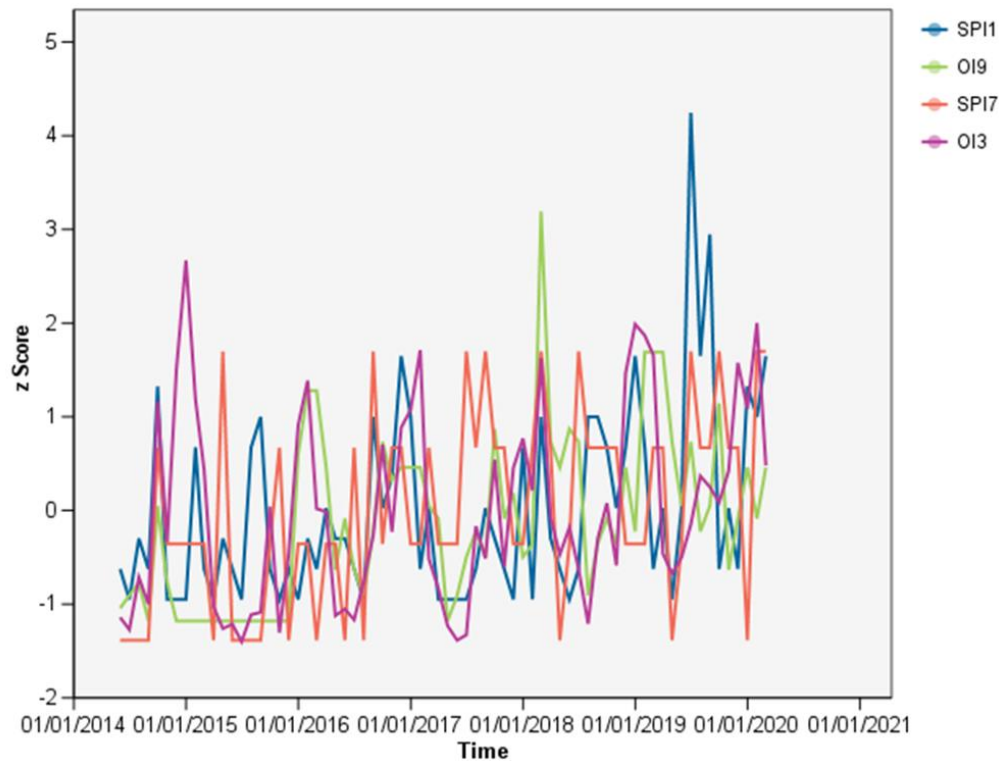
Figure 81 shows (on the left) impact diagram of causes of safety performance indicator SPI1 (number of occurrences/ hazards). There are eleven OIs and SPIs that directly (first lag in the Figure) impact (cause) the SPI1 values. Figure 81 shows (on the right) impact diagram of effects of safety performance indicator SPI1 (number of occurrences/ hazards). There are four SPIs on which SPI1 has direct (first lag in the Figure) impact (effect).



**Figure 81 Impact diagram of causes and effects of safety performance indicator SPI1**

*Source: Author using IBM SPSS Statistics*

Figure 82 shows top inputs for safety performance indicator SPI1 (number of occurrences/ hazards). There are four detected top inputs (OIs and SPIs) that directly can impact the SPI1 values: OI3, OI9, SPI1 and SPI7.



**Figure 82 Top inputs for safety performance indicator SPI1**

*Source: Author using IBM SPSS Statistics*

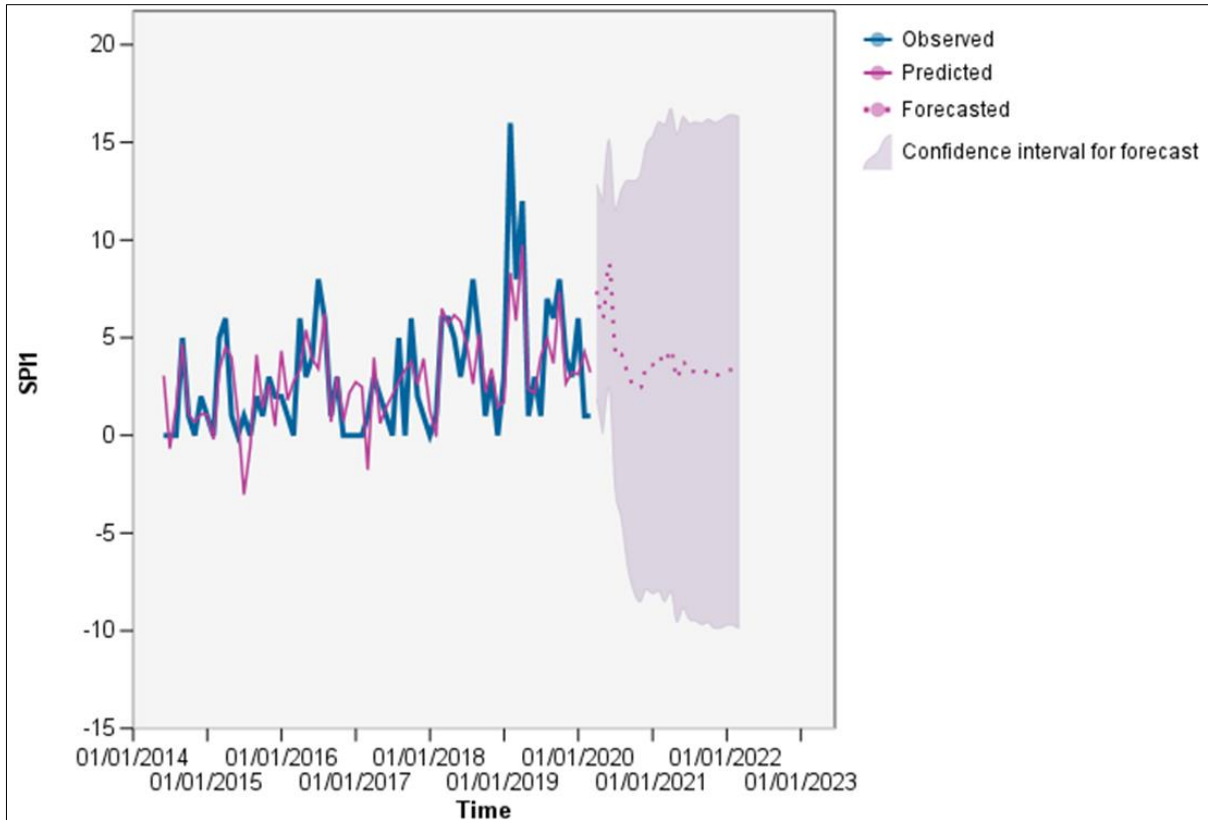
By learning this, it is possible to simulate increase or decrease of certain OIs and SPIs and see how it would affect the initially predicted values of SPIs. Next part of the research shows how forecasted (predicted) values of SPI1 can be affected, due to change (increase/ decrease) of top inputs for SPI1, i.e., OI3, OI9, and SPI7.

#### 6.2.5 Predicting safety performance indicators using predictive methods and causal modelling – scenarios and analyses

The results show how detecting relations between datasets, in this case organisational and safety performance indicators, can help determine correlations and impacts on one another, which in turn can point to week spots in the entire system. The example shows how increasing/ decreasing values of OIs can improve values of SPIs of the organisation, i.e., it can improve safety performance of the organisation.

Using cause-effect model, specifically their relations, it can be learned which indicators (variables) should be modified to obtained desired level of safety performance target (SPT) in each safety performance indicator (SPI).

For example, Figure 83 shows observed and predicted series for safety performance indicator SPI1, as well as the initial forecast of SPI1.

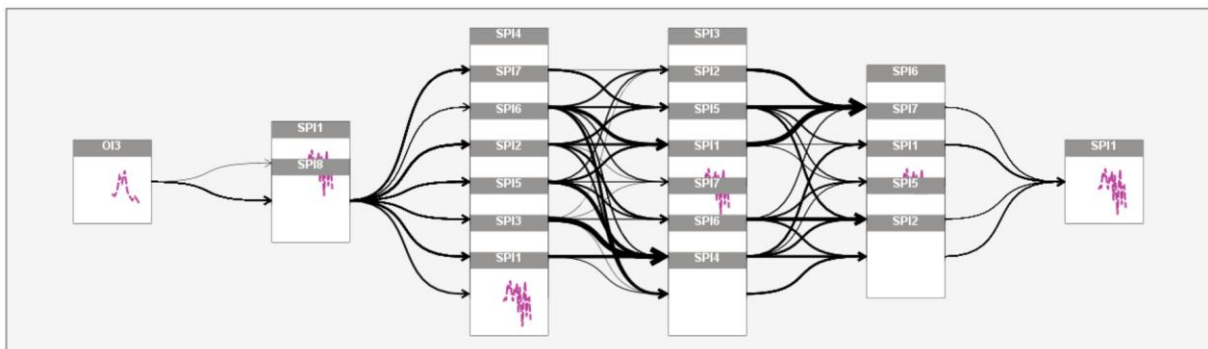


**Figure 83 Observed and predicted series for safety performance indicator SPI1**

*Source: Author using IBM SPSS Statistics*

By using an IBM SPSS Statistics function „Apply Temporal Causal Model” and „Run Scenarios” and using the top inputs for SPI1 (Figure 82), first scenario is created, and it examined and revealed how OI3 affects SPI1.

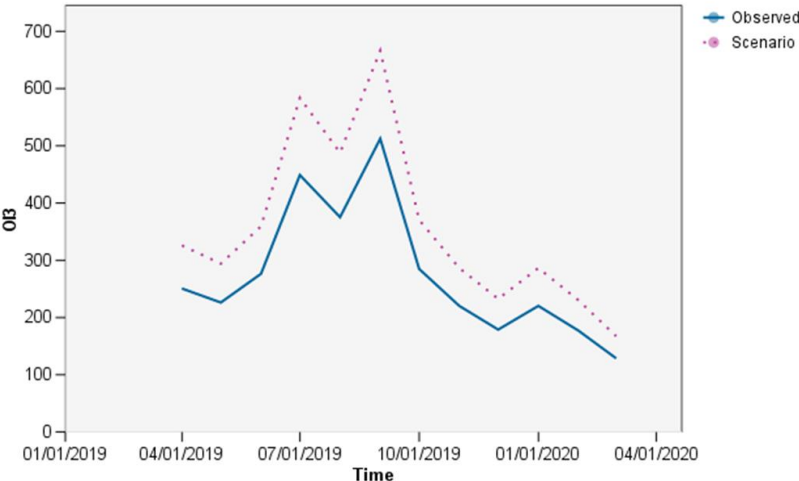
Figure 84 shows impact diagram of organisational indicator OI3 on safety performance indicator SPI1.



**Figure 84 Impact diagram of organisational indicator OI3 on safety performance indicator SPI1**

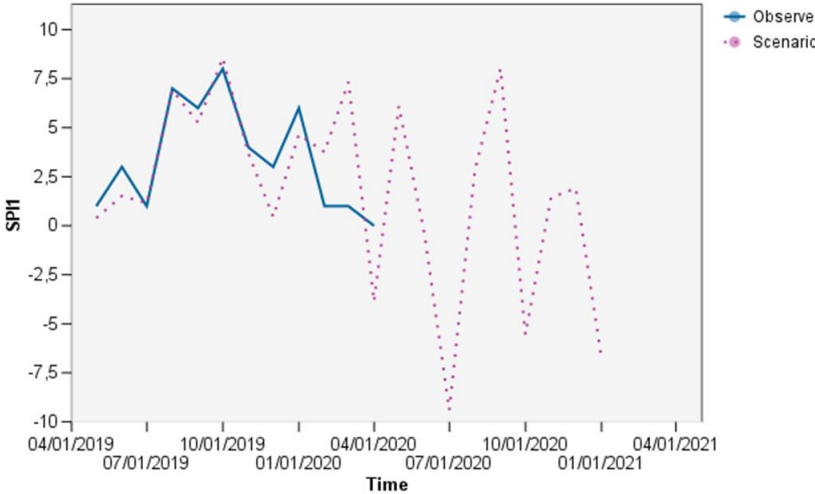
*Source: Author using IBM SPSS Statistics*

Figure 85 shows two series of organisational indicator OI3. First one (blue) is showing observed (initial) values in the period from April 2019 until March 2020, and second one (pink) shows scenario-adjusted values which in this case were initial ones increased by 30% in the period from April 2019 until March 2020.



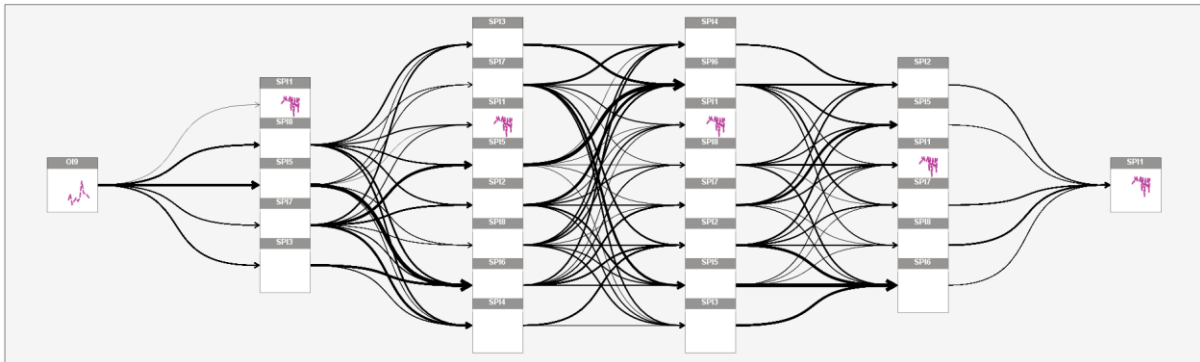
**Figure 85 Increase of organisational indicator OI3**  
*Source: Author using IBM SPSS Statistics*

Figure 86 shows two series of safety performance indicator SPI1. First one (blue) is showing observed (initial) values in the period from April 2019 until March 2020, and second one (pink) shows scenario-adjusted values due to applying causal model relations and increase of OI3, as well as it shows scenario-forecasted values. It can be observed that scenario SPI1 had slightly decreased as well, due to increase of OI3, and, in comparison with initial forecast of SPI1 (Figure 83).



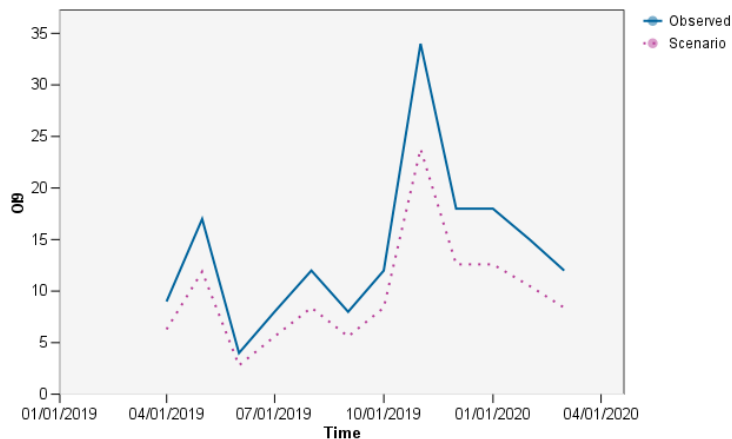
**Figure 86 Decrease of safety performance indicator SPI1 due to increase of OI3**  
*Source: Author using IBM SPSS Statistics*

Figure 87 shows impact diagram of organisational indicator OI9 on safety performance indicator SPI1.



**Figure 87 Impact diagram of organisational indicator OI9 on safety performance indicator SPI1**  
 Source: Author using IBM SPSS Statistics

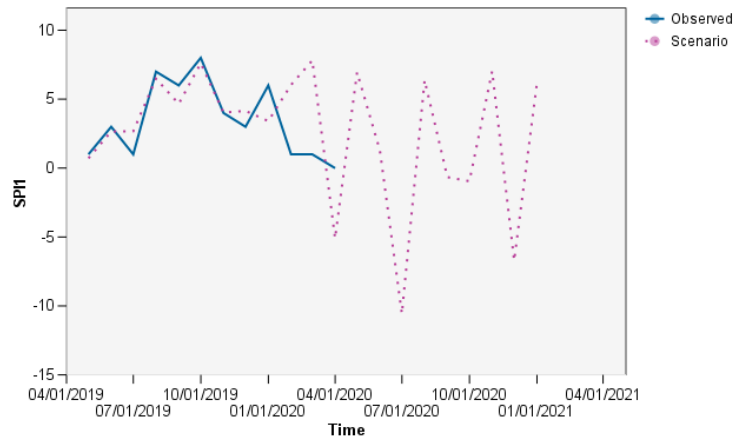
Figure 88 shows two series of organisational indicator OI9. First one (blue) is showing observed (initial) values in the period from April 2019 until March 2020, and second one (pink) shows scenario-adjusted values which in this case were initial ones decreased by 30% in the period from April 2019 until March 2020.



**Figure 88 Decrease of organisational indicator OI9**  
 Source: Author using IBM SPSS Statistics

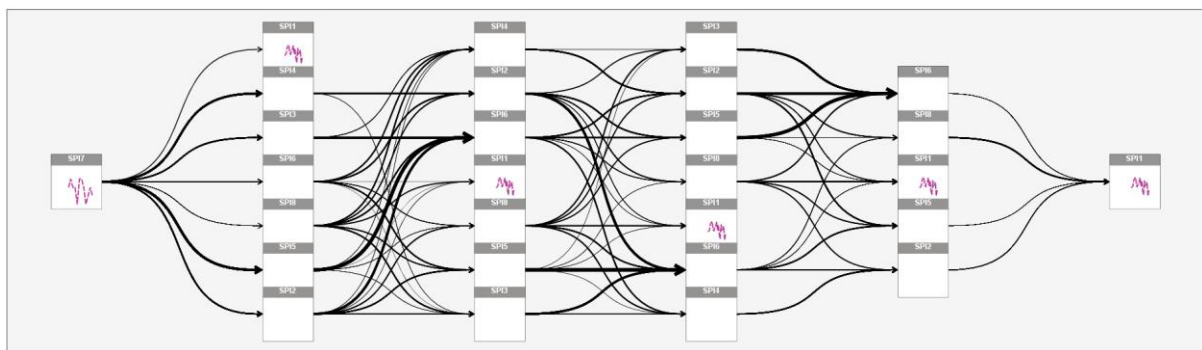
Figure 89 shows two series of safety performance indicator SPI1. First one (blue) is showing observed (initial) values in the period from April 2019 until March 2020, and second one (pink) shows scenario-adjusted values due to applying causal model relations and decrease of OI9, as well as it shows scenario-forecasted values. It can be observed that scenario SPI1 had slightly decreased as well, due to decrease of OI9, and, in comparison with initial forecast of SPI1 (Figure 83).





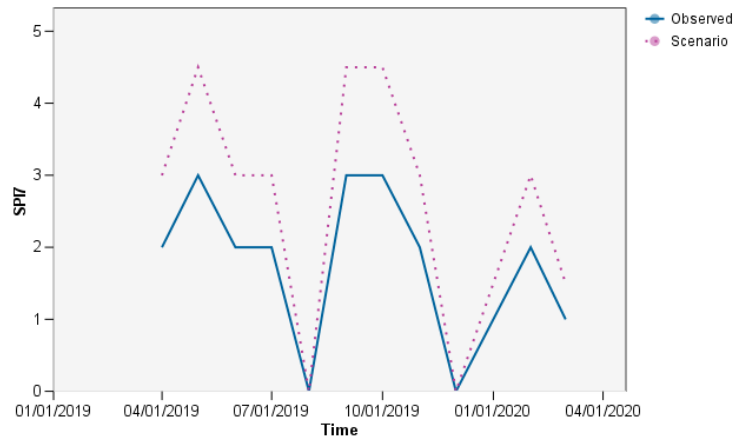
**Figure 89 Decrease of safety performance indicator SPI1 due to decrease of O19**  
*Source: Author using IBM SPSS Statistics*

Figure 90 shows impact diagram of safety performance indicator SPI7 on safety performance indicator SPI1.



**Figure 90 Impact diagram of safety performance indicator SPI7 on safety performance indicator SPI1**  
*Source: Author using IBM SPSS Statistics*

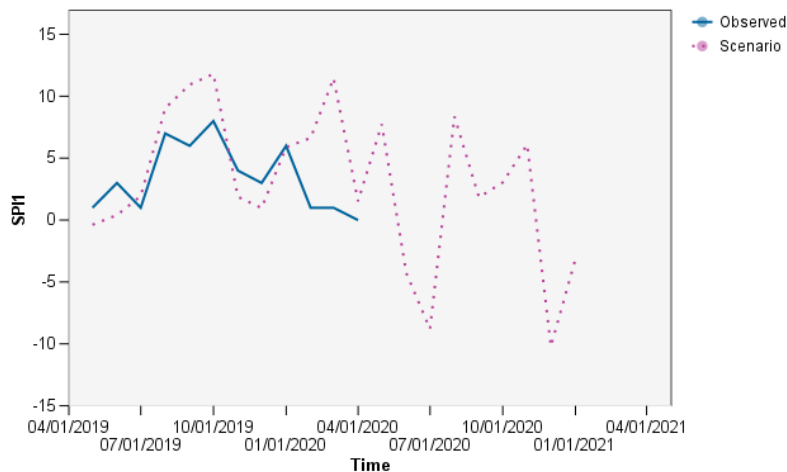
Figure 91 shows two series of safety performance indicator SPI7. First one (blue) is showing observed (initial) values in the period from April 2019 until March 2020, and second one (pink) shows scenario-adjusted values which in this case were initial ones increased by 50% in the period from April 2019 until March 2020.



**Figure 91 Increase of safety performance indicator SPI7**

*Source: Author using IBM SPSS Statistics*

Figure 92 shows two series of safety performance indicator SPI1. First one (blue) is showing observed (initial) values in the period from April 2019 until March 2020, and second one (pink) shows scenario-adjusted values due to applying causal model relations and increase of SPI7, as well as it shows scenario-forecasted values. It can be observed that scenario SPI1 had decreased as well, due to increase of SPI7, and, in comparison with initial forecast of SPI1 (Figure 83).



**Figure 92 Decrease of safety performance indicator SPI1 due to increase of SPI7**

*Source: Author using IBM SPSS Statistics*

This research proved that there are relations between organisational and safety performance indicators in the organisation. By comparing two forecasts, initial forecast and scenario forecast based on cause-effect model, it is proven that cause-effect model has indeed revealed true impacts of indicators to one another, and by revealing that, it opened the possibility to know which indicators to increase or decrease in order to obtain desired level of safety performance in the organisation.

## 7 CONCEPTUAL MODEL OF PREDICTIVE SAFETY MANAGEMENT IN AVIATION

According to the research conducted to analyse safety management methodologies in aviation, i.e., reactive, proactive and predictive, liaisons between these methodologies have been detected and established.

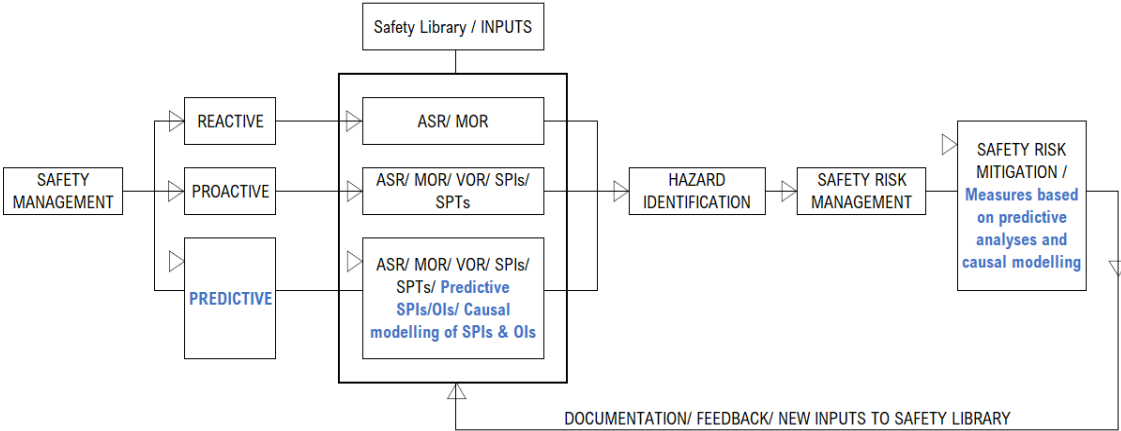
As literature review analysis showed, there have been attempts to use predictive methods in aviation safety management. All of the examples show usage of predictive methods in some particular segment of managing operational safety in aviation.

The idea of this thesis is to develop a new conceptual model of predictive safety management methodology, which would be an upgrade to previous reactive and proactive safety management methodologies.

Besides reactive and proactive methodology which identifies hazards through safety data collection via mandatory and voluntary occurrence reporting, predictive methodology uses predictive methods to identify potential and possible hazards based on predictive analyses (forecasts) that extract information from historical safety and current safety data to predict trends and behaviour patterns of emerging hazards.

Safety data collected and analysed with combining all three methodologies, i.e., using predictive safety management methodology, can create extensive and efficient safety database as well as improve safety performance measurement and decision-making process, and ultimately provide the organisations with additional knowledge of their own operations and safety issues.

The research conducted in previous chapters, helped establish steps and tools of predictive safety management methodology. This includes obtaining information on organisation’s safety performance in the future period, and through that, detecting future adverse occurrences, using predictive methods and causal modelling methods. Figure 93 shows predictive methodology incorporated in aviation safety management.



**Figure 93 Predictive methodology incorporated in aviation safety management**

*Source: Author*

By thoroughly analysing safety management methodologies and safety management systems in aviation, new insights and possibilities were revealed. By analysing existing methodologies in aviation safety management, it has been established that three methodologies were used, i.e., reactive, proactive and predictive. By looking closely at each of these safety management methodologies, necessary inputs (safety data) and tools used, were detected and described. Reactive methodology is used after event has already happened, and it uses historical data on similar previous events (mandatory occurrence reports) to determine the cause, in order to prevent the reoccurrence of the same or similar events. Proactive methodology is different than reactive one, as it tries to detect potential (latent) threats that could lead to serious incidents or accidents. Proactive methodology uses expanded set of safety information (in comparison to reactive one), i.e., it uses information from mandatory and voluntary safety reporting systems, safety audits and its findings, results from safety surveys, and from information regarding safety performance of the organisation, i.e., using tools of safety performance monitoring and measurement (safety performance indicators and targets). In the general description of safety management methodologies, there is strict division of these inputs and tools regarding each methodology, but as it can be observed, these two have an obvious overlap in mandatory occurrence reports, as it represents the input for both of these methodologies. It has been observed that proactive safety management methodology acts as an upgrade to reactive one. By taking next step in the research, i.e., analysis of existing “predictive” safety management methodology, it has been established, that existing so-called “predictive” safety management methodology refers to flight data monitoring and analysis systems in the real-time. It does not actually implement the use of predictive methods of any kind, but it is considered to be “predictive” because by gathering real-time data and analysing them gives the organisation insights in future emerging hazards, hence organisations can, by using these methods, anticipate, i.e., “predict” upcoming future hazards. It is also observed that existing “predictive” methods, besides using tools of real-time flight data monitoring and analysis, also use information from mandatory and voluntary safety reporting systems, safety audits and its findings, results from safety surveys, and from information regarding safety performance of the organisation, to make “predictive” analysis. Hence, it can also be observed that predictive safety management methodology acts as an upgrade to proactive one.

After establishing correlations between all existing safety management methodologies, the aim was to expand existing “predictive” safety management methodology with introducing use of predictive methods and causal modelling methods. The question was in which segment could these methods be of most use, and the answer is in the area of safety performance management. By predicting safety performance indicators with use of predictive methods, which are proactively monitored in an organisation, future hazards can be detected and anticipated. Using causal modelling methods, as another useful tool, causal relations between safety performance indicators (occurrences) can be detected and provide the organisation with the tool to mitigate anticipated future events (occurrences) in an organisation. Figure 94 shows improved aviation safety management system with graphical presentation of safety management methodologies, their correlation, inputs and tools, i.e., it presents conceptual model of predictive safety management in aviation.

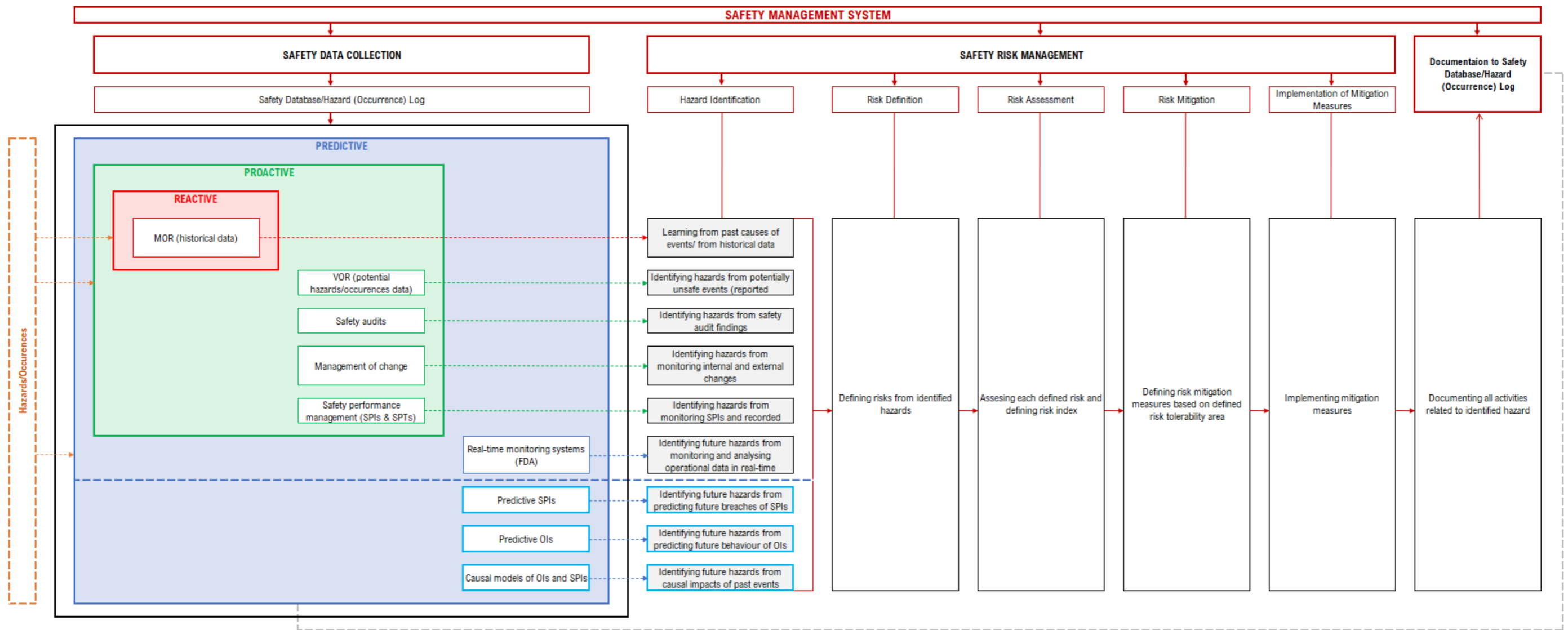


Figure 94 Conceptual model of predictive safety management in aviation

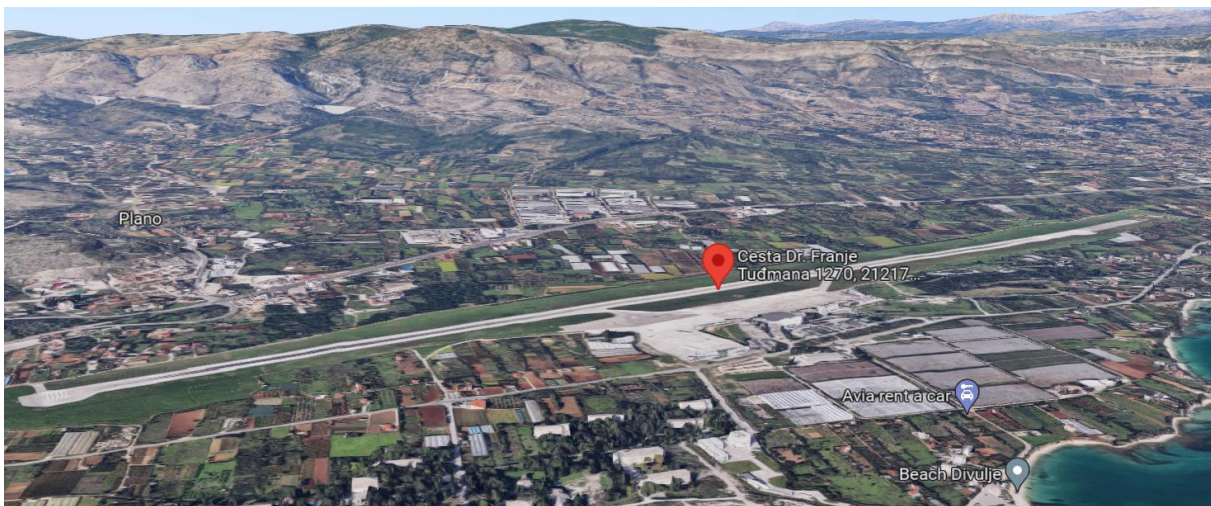
Source: Author

## 8 VALIDATION AND VERIFICATION OF CONCEPTUAL MODEL OF PREDICTIVE SAFETY MANAGEMENT ON THE SAMPLE OF SPLIT AIRPORT

Split Airport is one of nine airports in Croatia. It is located in the Resnik area west of Kaštel Štafilić, 6 km from Trogir and 25 km from Split (Figure 95). The main elements of the airport infrastructure include manoeuvring surfaces (runway (05/23), apron, etc.), passenger and cargo terminal, control tower, access roads, parking lots for buses and cars, and additional service and commercial facilities. Split Airport was opened on 15 November 1966. The number of passengers grew year by year. This growth was stopped in 1988 due to the economic crisis. In September 1991, it was closed due to the war, and in April 1992, it was reopened. Recently, in 2020, COVID-19 pandemic did major setback on Split Airport traffic, for even 79%, due to strict epidemiological measures.

The traffic is recovering gradually, and in 2021 it reached 50% of traffic accomplished 2019. In 2019, the airport was the second busiest in Croatia after Zagreb Airport, handling 3.3 million passengers. The Split Airport was recorded to be the busiest airport in Croatia in 2021, handling 1.57 million passengers, and surpassing Zagreb Airport for the first time (Split Airport, 2022).

Due to significant increase in passenger traffic, especially during the summer months, an expansion project was completed in summer of 2019, adding more than three times the floor space of the original terminal building, and increasing the capacity to 5 million passengers per year. Original terminal has been refurbished and is still being used for some international departures, while check in, all domestic departures as well as both international and domestic arrivals including baggage claim is located in the new areas. As a part of the expansion project, an enclosed bridge was built over the state road D409, taking passengers to the newly built parking lot, bus terminal and rental car facilities (Split Airport, 2022).



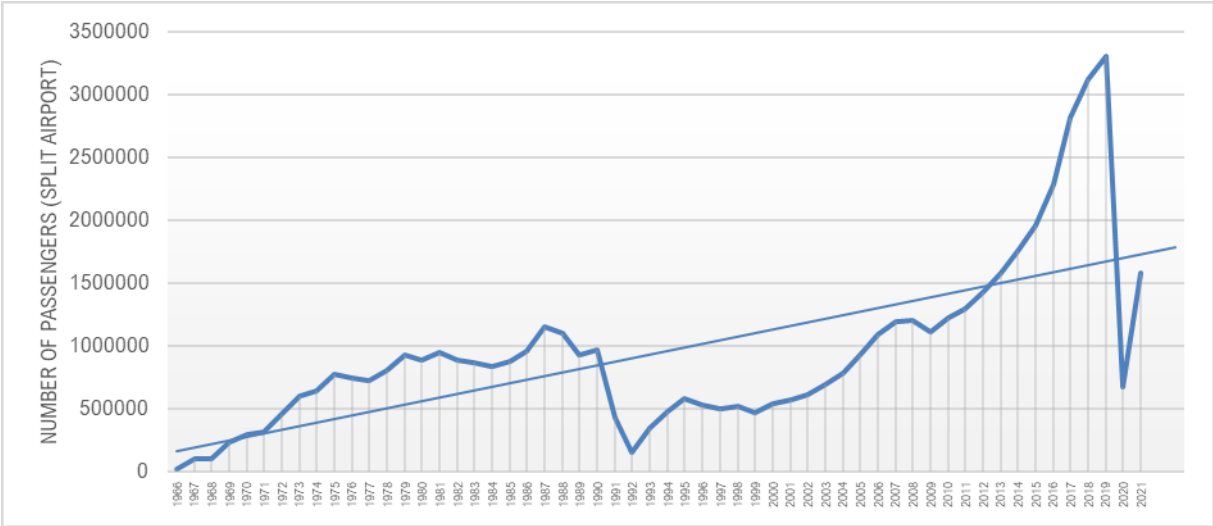
**Figure 95 Split Airport**  
Source: (Google Maps, 2022)

Table 37 shows yearly number of passengers (passenger traffic) at Split Airport in the period from 1966 to 2021. Data is provided by Split Airport (Split Airport, 2022). Figure 96 shows graphically passenger traffic at Split Airport in the period from 1966 to 2021 with accompanying trendline.

**Table 37 Number of passengers at Split Airport in the period from 1966 to 2021**

Year	Number of passengers	Year	Number of passengers	Year	Number of passengers	Year	Number of passengers
1966	22461	1980	885398	1994	482563	2008	1203778
1967	105274	1981	949674	1995	579025	2009	1115099
1968	105737	1982	884524	1996	527006	2010	1219741
1969	235000	1983	864202	1997	497776	2011	1300381
1970	298000	1984	839777	1998	524758	2012	1425749
1971	317221	1985	876913	1999	465166	2013	1581734
1972	457511	1986	964544	2000	540603	2014	1752657
1973	601956	1987	1151580	2001	568625	2015	1955400
1974	641361	1988	1103627	2002	617005	2016	2289987
1975	778865	1989	929116	2003	698128	2017	2818176
1976	745532	1990	972436	2004	788771	2018	3124067
1977	722551	1991	430681	2005	934049	2019	3301930
1978	810113	1992	150454	2006	1095852	2020	669702
1979	928889	1993	349311	2007	1190551	2021	1577584

Source: Author according to (Split Airport, 2022)



**Figure 96 Passenger traffic and trendline at Split Airport in the period from 1966 to 2021**

Source: Author according to (Split Airport, 2022)

## 8.1 Analysis of Split Airport safety database

In this part, the aim is to establish predictive causal model of defined organisational and safety performance indicators (SPIs) in order to present relations between organisational and safety performance indicators in an organisation – in this case: airport operator – Split Airport. Detecting relations between indicators indicates impacts (causes or effects) of indicators to one another, which in turn gives a possibility to improve planning of future actions with enhanced forecasting (prediction) techniques that can improve safety performance at the airport.

A dataset of actual organisational and safety performance indicators was used. Dataset is representing safety data of Split Airport (Split Airport, 2022).

Split Airport provides the services of passenger, cargo, and aircraft handling in the domestic and international air transport, as its core business. Applied safety management methodologies at Split Airport, in terms of gathering and processing safety data, are reactive and proactive. The Airport uses sophisticated software to manage safety, i.e., Galiot Aero SMS. As a part of the Safety Assurance component, Split Airport has established set of safety performance indicators (SPIs) and set-up accompanying safety performance targets (SPTs). SPIs are monitored on monthly basis. The list of organisational indicators (OIs), safety performance indicators (SPIs) and safety performance targets (SPTs) of the Split Airport SMS are presented and in the following Table 38 (Split Airport, 2022).

**Table 38 List of organisational and safety performance indicators in observed dataset at the Split Airport**

Mark	Name of organisational/safety performance indicator	Targets* (for SPIs)
OI1	Number of aircraft operations	/
OI2	Number of passengers	/
SPI1	Number of occurrences related to LIRF and loadsheet crosscheck	≤1/10000
SPI2	Number of occurrences related to wrong figures for loadsheet	≤1/10000
SPI3	Number of dangerous goods incidents	≤1/10000
SPI4	Number of aircraft damage occurrences	≤1/100
SPI5	Number of personnel or passenger injuries	≤1/1000
SPI6	Number of runway incursions/excursions	≤1/10000
SPI7	Number of training deficiencies	≤1/1000
SPI8	Number of apron maintenance incidents	≤1/1000
SPI9	Number of vehicle maintenance incidents	≤1/1000
SPI10	Number of occurrences related to manoeuvring area maintenance	≤1/1000
SPI11	Number of occurrences related to communication	≤1/10000
SPI12	Number of incidents related to taxiing to/from apron	≤1/1000
SPI13	Number of aircraft marshalling occurrences	≤1/1000
SPI14	Number of occurrences related to FOD presence	≤1/1000
SPI15	Number of occurrences related to passenger handling at the gate	≤1/1000
SPI16	Number of occurrences related to passenger handling – disembarking/embarking	≤1/1000
SPI17	Number of occurrences related to personal protective equipment	≤1/1000
SPI18	Number of aircraft chocking incidents	≤1/1000
SPI19	Number of aircraft conning incidents	≤1/1000
SPI20	Number of occurrences related to baggage loading/unloading	≤1/1000
SPI21	Number of occurrences related to ground traffic (GSE) and vehicle driving	≤1/1000
SPI22	Number of anti-collision occurrences	≤1/1000



SPI23	Number of engine start-up incidents	≤1/1000
SPI24	Number of occurrences related to wildlife	≤1/1000
SPI25	Number of occurrences related to fuel handling	≤1/1000

\*Safety Performance Targets (SPTs): Number of occurrences versus number of aircraft operations.

Source: Author according to (Split Airport, 2022)

A dataset is composed of monthly entries for 2 organisational indicators (OIs) and 25 safety performance indicators (SPIs). The observed period is from January 2014 until December 2021. The dataset contains 96 entries.

Table 39 shows a dataset of monthly organisational indicators (OIs) and safety performance indicators (SPIs) of Split Airport, in the period from January 2014 to December 2021 (Split Airport, 2022). There are 27 indicators in total: OI1 – Number of aircraft operations, OI2 – Number of passengers, SPI1 – Number of occurrences related to LIRF and loadsheet crosscheck, SPI2 – Number of occurrences related to wrong figures for loadsheet, SPI3 – Number of dangerous goods incidents, SPI4 – Number of aircraft damage occurrences, SPI5 – Number of personnel or passenger injuries, SPI6 – Number of runway incursions/excursions, SPI7 – Number of training deficiencies, SPI8 – Number of apron maintenance incidents, SPI9 – Number of vehicle maintenance incidents, SPI10 – Number of occurrences related to manoeuvring area maintenance, SPI11 – Number of occurrences related to communication, SPI12 – Number of incidents related to taxiing to/from apron, SPI13 – Number of aircraft marshalling occurrences, SPI14 – Number of occurrences related to FOD presence, SPI15 – Number of occurrences related to passenger handling at the gate, SPI16 – Number of occurrences related to passenger handling – disembarking/embarking, SPI17 – Number of occurrences related to personal protective equipment, SPI18 – Number of aircraft chocking incidents, SPI19 – Number of aircraft conning incidents, SPI20 – Number of occurrences related to baggage loading/unloading, SPI21 – Number of occurrences related to ground traffic (GSE) and vehicle driving, SPI22 – Number of anti-collision occurrences, SPI23 – Number of engine start-up incidents, SPI24 – Number of occurrences related to wildlife, and SPI25 – Number of occurrences related to fuel handling.

Table 40 shows achieved safety performance targets (SPTs) in the period from January 2014 to December 2021 (Split Airport, 2022). All deviations from defined targets (Table 38) are marked in red.

It can be observed that all SPIs are number of occurrences in different segments of airport operations. Figure 97 shows which areas are most critical in observed time period from January 2014 until December 2021, i.e., SPI15 – Number of occurrences related to passenger handling at the gate (which even reached 16 occurrences per month in 2016), SPI21 – Number of occurrences related to ground traffic (GSE) and vehicle driving (which reached 8 occurrences per month in 2018), and SPI24 – Number of occurrences related to wildlife (which even reached 13 occurrences per month in 2019).

**Table 39 Dataset of organisational indicators (OIs) and safety performance indicators (SPIs) at the Split Airport**

Month-Year	OI1	OI2	SPI1	SPI2	SPI3	SPI4	SPI5	SPI6	SPI7	SPI8	SPI9	SPI10	SPI11	SPI12	SPI13	SPI14	SPI15	SPI16	SPI17	SPI18	SPI19	SPI20	SPI21	SPI22	SPI23	SPI24	SPI25
Jan-14	438	24900	0	0	0	0	0	0	0	0	0	0	0	0	0	0	0	0	0	0	0	0	1	0	0	0	0
Feb-14	392	20825	0	0	0	0	0	0	0	0	0	0	0	0	0	0	0	0	1	0	0	1	0	0	0	0	0
Mar-14	514	26410	0	0	0	0	0	0	0	0	0	0	0	0	0	1	0	0	0	0	0	1	1	0	0	1	0
Apr-14	1032	77575	0	0	0	0	0	0	0	2	0	4	1	0	0	0	0	0	0	0	0	0	1	0	0	0	0
May-14	1942	157070	0	0	0	0	0	0	0	1	0	0	0	0	0	0	0	1	0	0	0	0	1	0	0	1	0
Jun-14	2554	234139	0	0	0	0	2	0	0	1	0	0	0	0	1	1	1	0	1	0	0	1	6	0	0	0	0
Jul-14	3872	386039	0	0	1	0	1	0	0	0	0	0	0	0	1	0	5	0	0	0	0	0	1	0	0	10	0
Aug-14	3954	389032	0	0	0	0	0	0	0	0	1	1	0	0	0	0	0	1	0	0	0	0	3	0	1	1	0
Sep-14	2592	240991	0	0	0	1	0	0	0	1	1	0	0	0	0	1	2	0	0	0	0	1	0	0	1	2	0
Oct-14	1470	114161	0	0	0	0	0	0	0	1	0	0	0	0	0	0	0	0	0	0	0	0	1	0	0	2	0
Nov-14	504	27359	0	0	0	0	0	0	0	0	0	0	0	0	0	0	0	0	0	0	0	0	0	0	0	0	0
Dec-14	528	30811	0	0	0	0	0	0	0	0	0	0	0	0	0	0	0	0	0	0	0	0	0	0	0	0	0
Jan-15	504	23513	0	0	0	0	0	0	0	0	0	1	0	0	0	0	0	0	0	0	0	0	0	0	0	0	0
Feb-15	454	22234	0	0	0	0	0	0	0	0	0	0	0	0	0	0	0	0	0	0	0	0	2	0	0	0	0
Mar-15	576	31941	0	0	0	0	0	0	0	0	0	0	0	0	0	1	0	0	0	0	0	0	0	0	0	0	0
Apr-15	1132	73149	0	0	0	0	0	0	0	0	0	0	0	0	1	0	2	0	0	0	0	0	1	0	0	2	0
May-15	2232	179794	0	0	1	0	0	0	0	0	1	0	0	0	0	0	1	0	0	0	0	0	1	0	1	0	0
Jun-15	2942	267755	0	0	0	0	0	0	0	1	0	0	0	0	0	0	1	1	0	0	0	2	1	0	1	1	0
Jul-15	4374	431014	1	0	1	1	1	0	0	0	0	0	0	0	1	10	0	0	1	0	0	1	3	0	0	4	1
Aug-15	4162	427830	0	0	0	0	1	0	0	0	0	0	0	0	0	10	0	1	0	0	0	0	2	0	0	3	0
Sep-15	2826	285446	0	0	0	0	1	0	0	1	0	0	0	0	0	6	0	0	0	0	0	0	1	0	0	0	0
Oct-15	1582	133129	0	0	0	0	0	0	0	1	0	0	0	0	0	2	0	0	0	0	0	0	1	0	0	0	0
Nov-15	640	27938	0	0	0	0	0	0	0	0	1	0	0	0	0	0	0	0	0	0	0	0	0	0	0	0	0
Dec-15	564	27137	0	0	0	0	0	0	0	1	0	0	0	0	0	1	0	0	0	0	0	0	0	0	0	0	0
Jan-16	492	25028	0	0	0	0	0	0	0	0	0	0	0	0	0	0	0	0	0	0	0	0	1	0	0	0	0
Feb-16	494	22782	0	0	0	0	0	0	0	0	1	0	0	0	0	0	0	0	0	0	0	0	3	0	0	1	0
Mar-16	624	33477	1	0	0	0	1	0	1	0	0	0	0	0	0	0	1	0	0	0	0	0	0	0	0	0	0
Apr-16	1142	73764	0	0	0	0	0	0	0	0	0	0	0	0	0	1	0	0	0	0	0	0	1	0	0	0	0
May-16	2390	201906	0	0	1	0	2	0	1	0	0	0	0	0	0	6	0	1	0	0	1	2	0	0	0	2	0
Jun-16	3148	319135	0	0	1	0	0	0	0	0	0	0	0	0	0	14	0	0	0	0	0	2	3	0	0	1	1
Jul-16	4824	540778	0	0	0	0	1	0	0	0	1	0	0	0	0	16	0	0	0	0	0	0	3	0	0	0	0
Aug-16	4518	483215	0	0	0	1	1	0	0	1	0	0	0	0	0	15	1	0	0	0	0	1	3	0	0	0	1
Sep-16	3280	337967	0	0	0	0	1	0	0	1	0	0	1	0	1	5	0	0	0	0	0	3	5	1	0	2	2
Oct-16	1876	165299	0	0	0	0	0	0	0	0	0	0	0	0	0	2	0	0	0	0	0	2	1	0	0	1	0
Nov-16	582	30676	0	0	0	0	0	0	0	0	0	0	0	0	0	0	0	0	0	0	0	0	1	0	0	0	0
Dec-16	570	28779	0	0	0	0	0	0	0	0	0	0	0	0	0	2	0	0	0	0	0	0	0	0	0	0	0
Jan-17	586	28994	0	0	0	1	0	0	0	0	0	1	0	0	0	0	1	0	0	0	0	0	0	0	0	0	0
Feb-17	496	22646	0	0	0	0	0	0	0	0	0	0	0	0	0	0	0	0	0	1	0	0	0	0	0	1	1
Mar-17	640	31878	1	0	0	0	0	0	0	0	0	0	0	0	0	0	0	0	0	0	0	0	0	0	0	1	1
Apr-17	1378	120980	0	0	0	0	0	0	0	0	0	0	0	0	0	1	0	0	0	0	0	0	0	0	0	1	0
May-17	2644	254265	0	0	0	0	1	0	0	0	1	0	0	0	0	3	0	0	0	0	0	0	1	0	0	3	0
Jun-17	3594	401347	0	0	0	0	0	0	0	0	0	0	0	0	0	6	0	0	0	0	0	0	5	1	0	0	1
Jul-17	5216	653743	0	0	0	0	3	0	0	0	0	0	0	0	0	7	0	0	0	0	0	0	0	0	0	2	0
Aug-17	5078	590830	0	0	0	0	0	0	0	1	0	0	0	0	0	0	0	0	0	0	0	0	4	0	0	3	0
Sep-17	378	418836	0	0	0	0	0	0	0	0	0	0	0	0	0	1	0	0	0	0	0	0	0	0	0	4	1
Oct-17	2116	195837	0	0	0	0	0	0	0	0	0	0	0	0	1	0	0	0	1	1	1	0	0	0	0	1	1
Nov-17	654	37343	0	0	0	0	0	0	0	0	0	1	0	0	1	0	0	0	0	0	0	0	0	0	0	0	0
Dec-17	554	34626	0	0	0	0	0	0	0	0	0	0	0	0	0	0	0	0	0	0	0	0	0	0	0	0	0
Jan-18	590	32006	0	0	0	0	0	0	0	0	0	1	0	0	0	0	0	0	0	0	0	0	1	0	0	0	0
Feb-18	520	29109	0	0	0	0	0	0	0	0	0	1	0	0	0	1	0	0	0	2	0	0	0	0	0	1	0
Mar-18	748	51331	0	0	0	0	0	0	0	0	0	1	0	1	0	0	0	0	0	0	0	0	2	0	0	0	0
Apr-18	1486	121372	0	0	0	0	0	0	0	0	0	0	0	0	0	1	0	0	0	0	0	1	1	0	0	2	0
May-18	2878	301377	0	0	0	0	0	0	0	0	0	0	0	0	0	5	0	0	0	0	0	0	1	0	0	0	0
Jun-18	4052	471962	0	0	0	0	0	0	0	0	0	0	0	0	0	2	0	0	0	0	0	0	0	0	0	0	1
Jul-18	5504	691810	0	0	0	0	1	0	0	0	0	0	0	0	0	6	0	0	0	0	0	2	8	0	0	1	0
Aug-18	5136	625209	0	0	0	0	0	0	0	0	0	1	0	0	1	0	5	1	0	0	0	3	0	0	0	3	0
Sep-18	3842	452964	0	0	0	0	0	0	0	0	0	0	0	0	0	4	0	1	0	0	0	0	3	0	0	4	0
Oct-18	2272	223092	0	0	0	0	2	0	0	0	1	0	0	0	0	5	0	0	0	0	0	1	1	1	0	0	0

Nov-18	750	52942	0	0	0	0	0	0	0	0	0	0	0	0	0	2	0	0	0	0	0	1	0	0	0	0
Dec-18	646	42434	0	0	0	0	0	0	0	0	0	0	0	0	0	0	0	0	0	0	0	0	0	0	0	0
Jan-19	664	34694	0	0	0	0	0	0	0	0	0	0	0	0	0	0	0	0	0	0	0	0	0	0	0	0
Feb-19	634	33087	0	0	0	0	0	0	0	0	0	0	0	0	0	0	0	0	0	0	0	3	0	0	0	0
Mar-19	800	48095	0	0	0	0	0	0	1	0	0	0	0	1	0	0	0	0	0	0	0	0	0	0	0	0
Apr-19	1698	153474	0	0	0	0	0	0	0	0	0	0	1	0	4	0	0	0	0	0	0	1	0	0	1	0
May-19	2992	308447	0	0	0	0	1	0	0	0	0	0	0	0	1	0	0	0	0	0	0	1	0	0	2	0
Jun-19	4318	510438	0	0	0	0	0	0	0	0	0	0	0	0	5	0	0	0	0	0	1	1	0	0	2	0
Jul-19	5576	719796	2	0	1	0	1	0	0	0	0	0	0	0	1	0	0	0	0	0	0	2	0	0	13	0
Aug-19	5320	669403	0	0	0	0	0	0	1	0	1	0	0	0	2	2	0	0	0	0	1	2	0	0	5	0
Sep-19	3848	467544	0	0	0	0	0	0	0	0	0	0	0	0	0	0	0	0	0	0	1	0	0	0	0	0
Oct-19	2372	244259	0	0	3	0	0	0	0	0	2	0	0	0	1	0	0	0	0	0	0	4	0	0	0	0
Nov-19	634	42859	0	0	1	0	0	0	0	0	0	0	0	0	2	0	0	0	0	0	0	0	0	0	1	0
Dec-19	574	38949	0	0	0	0	0	0	0	0	0	0	0	0	2	0	0	0	0	0	0	1	0	0	0	0
Jan-20	567	35282	0	0	0	0	0	0	0	0	0	0	0	0	0	0	0	0	0	0	1	0	0	0	0	0
Feb-20	474	24606	0	0	0	0	0	0	0	0	0	0	0	0	0	0	0	0	0	0	0	0	0	0	0	0
Mar-20	370	16117	0	0	0	0	0	0	0	0	0	0	0	0	0	0	0	0	0	0	0	0	0	0	0	0
Apr-20	16	0	0	0	0	0	0	0	1	0	0	0	0	0	0	0	0	0	0	0	0	0	0	0	0	0
May-20	194	2319	0	0	0	0	0	0	0	0	0	0	0	0	0	0	0	0	0	0	0	0	0	0	0	0
Jun-20	818	24929	0	0	0	0	0	0	0	0	0	0	0	0	2	0	0	1	0	0	0	0	0	0	1	0
Jul-20	2757	169229	0	0	0	0	3	0	0	0	0	0	0	0	0	11	1	0	0	0	1	0	0	0	6	0
Aug-20	3676	271362	1	0	0	0	0	0	0	0	0	1	0	0	7	0	0	0	0	0	0	0	0	0	0	0
Sep-20	1807	74653	0	0	0	0	0	0	0	0	0	0	0	0	2	0	0	0	0	0	1	0	0	1	0	0
Oct-20	720	25050	0	0	0	0	0	0	0	0	0	0	0	0	1	0	0	0	0	0	0	0	0	1	1	1
Nov-20	410	7658	0	0	1	0	0	0	0	0	0	0	0	0	0	0	0	0	0	0	0	0	0	0	0	0
Dec-20	341	8145	0	0	0	0	0	0	0	0	0	0	0	0	0	0	0	0	0	0	0	0	0	0	0	0
Jan-21	314	7415	0	0	0	0	0	0	0	0	0	0	0	0	0	0	0	0	0	0	0	0	0	0	0	0
Feb-21	274	5706	0	0	0	0	0	0	0	0	0	0	0	0	0	0	0	0	0	0	0	0	0	0	0	0
Mar-21	358	8031	0	0	0	0	0	0	0	0	0	0	0	0	0	0	0	0	0	0	0	0	0	0	0	0
Apr-21	587	13964	0	0	0	0	0	0	0	0	0	0	0	0	0	0	0	0	0	0	0	0	0	0	0	0
May-21	883	32754	0	0	0	0	0	0	0	0	0	0	0	0	2	0	0	0	0	0	1	0	0	0	0	0
Jun-21	2051	114687	0	0	0	0	1	0	0	0	0	0	0	0	2	0	0	0	0	0	2	0	0	1	0	0
Jul-21	4084	349042	0	1	0	0	0	0	2	0	0	0	0	0	0	2	0	0	0	0	0	0	0	0	0	0
Aug-21	4728	491358	0	0	0	0	0	0	0	0	0	0	0	0	0	0	0	0	0	0	1	0	0	7	1	
Sep-21	3435	326347	0	0	0	0	0	0	0	0	0	0	0	0	1	0	0	0	0	1	1	0	0	1	0	0
Oct-21	2090	160720	0	0	0	0	1	0	0	0	0	0	0	0	0	0	0	0	0	0	0	0	0	0	0	0
Nov-21	613	25726	0	0	0	0	0	0	0	0	0	0	0	0	0	0	0	0	0	0	0	0	0	0	0	0
Dec-21	615	23428	0	0	0	0	0	0	0	0	0	0	0	0	0	0	0	0	0	1	0	0	0	0	0	0

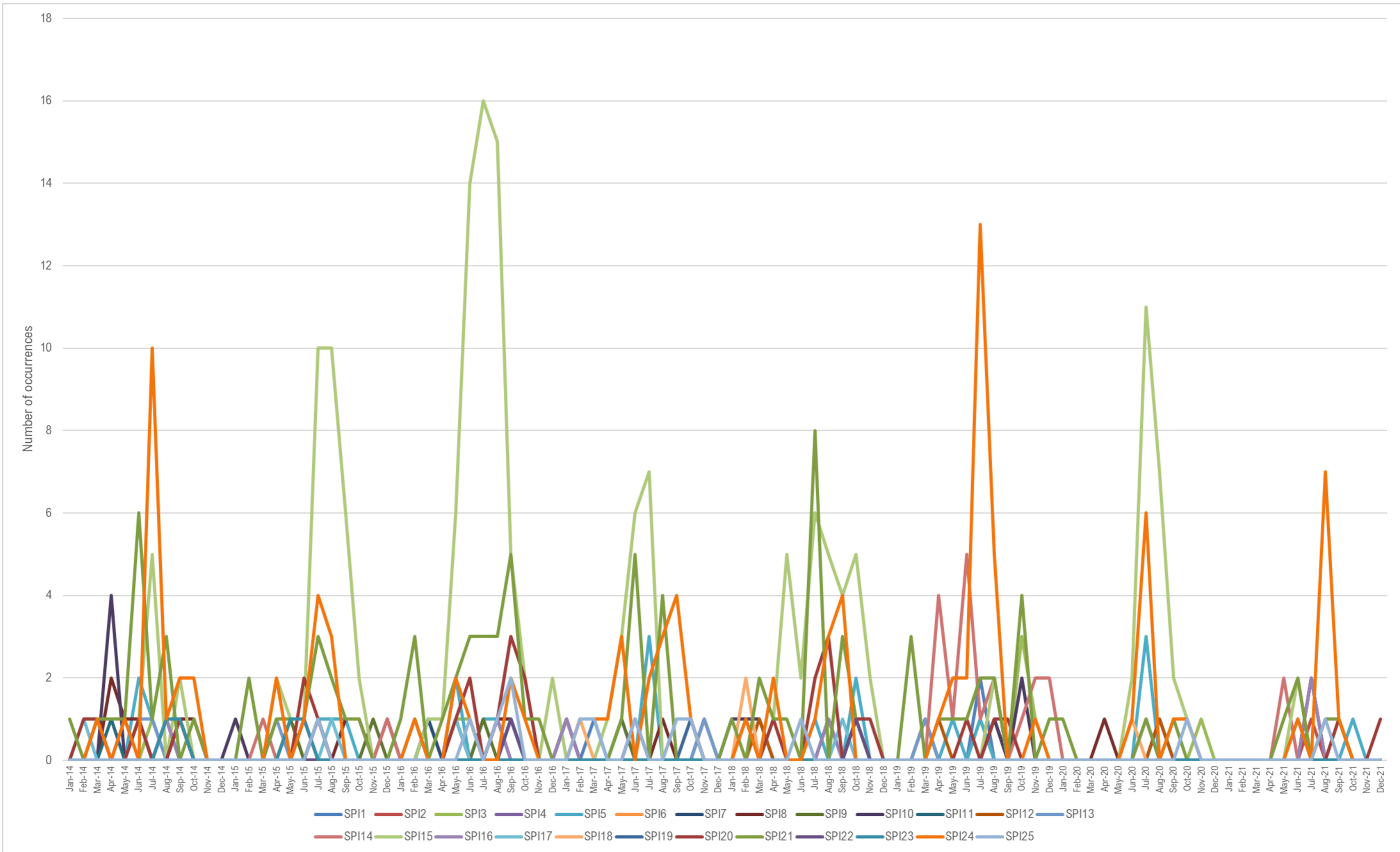
Source: Author according to (Split Airport, 2022)

Table 40 Dataset of achieved safety performance targets (SPTs) at the Split Airport

Month-Year	SPT1	SPT2	SPT3	SPT4	SPT5	SPT6	SPT7	SPT8	SPT9	SPT10	SPT11	SPT12	SPT13	SPT14	SPT15	SPT16	SPT17	SPT18	SPT19	SPT20	SPT21	SPT22	SPT23	SPT24	SPT25
Jan-14	0.0000	0.0000	0.0000	0.0000	0.0000	0.0000	0.0000	0.0000	0.0000	0.0000	0.0000	0.0000	0.0000	0.0000	0.0000	0.0000	0.0000	0.0000	0.0000	0.0000	0.0023	0.0000	0.0000	0.0000	0.0000
Feb-14	0.0000	0.0000	0.0000	0.0000	0.0000	0.0000	0.0000	0.0000	0.0000	0.0000	0.0000	0.0000	0.0000	0.0000	0.0000	0.0000	0.0026	0.0000	0.0000	0.0026	0.0000	0.0000	0.0000	0.0000	0.0000
Mar-14	0.0000	0.0000	0.0000	0.0000	0.0000	0.0000	0.0000	0.0000	0.0000	0.0000	0.0000	0.0000	0.0000	0.0019	0.0000	0.0000	0.0000	0.0000	0.0000	0.0019	0.0019	0.0000	0.0000	0.0019	0.0000
Apr-14	0.0000	0.0000	0.0000	0.0000	0.0000	0.0000	0.0000	0.0019	0.0000	0.0039	0.0010	0.0000	0.0000	0.0000	0.0000	0.0000	0.0000	0.0000	0.0000	0.0010	0.0000	0.0000	0.0000	0.0000	0.0000
May-14	0.0000	0.0000	0.0000	0.0000	0.0000	0.0000	0.0000	0.0005	0.0000	0.0000	0.0000	0.0000	0.0000	0.0000	0.0000	0.0005	0.0000	0.0000	0.0000	0.0000	0.0005	0.0000	0.0000	0.0005	0.0000
Jun-14	0.0000	0.0000	0.0000	0.0000	0.0008	0.0000	0.0000	0.0004	0.0000	0.0000	0.0000	0.0000	0.0004	0.0004	0.0004	0.0000	0.0004	0.0000	0.0000	0.0004	0.0023	0.0000	0.0000	0.0000	0.0000
Jul-14	0.0000	0.0000	0.0003	0.0000	0.0003	0.0000	0.0000	0.0000	0.0000	0.0000	0.0000	0.0000	0.0003	0.0000	0.0013	0.0000	0.0000	0.0000	0.0000	0.0000	0.0003	0.0000	0.0000	0.0026	0.0000
Aug-14	0.0000	0.0000	0.0000	0.0000	0.0000	0.0000	0.0000	0.0000	0.0003	0.0003	0.0000	0.0000	0.0000	0.0000	0.0000	0.0003	0.0000	0.0000	0.0000	0.0000	0.0008	0.0000	0.0003	0.0003	0.0000
Sep-14	0.0000	0.0000	0.0000	0.0004	0.0000	0.0000	0.0000	0.0004	0.0004	0.0000	0.0000	0.0000	0.0000	0.0004	0.0008	0.0000	0.0000	0.0000	0.0000	0.0004	0.0000	0.0000	0.0004	0.0008	0.0000
Oct-14	0.0000	0.0000	0.0000	0.0000	0.0000	0.0000	0.0000	0.0007	0.0000	0.0000	0.0000	0.0000	0.0000	0.0000	0.0000	0.0000	0.0000	0.0000	0.0000	0.0000	0.0007	0.0000	0.0000	0.0014	0.0000
Nov-14	0.0000	0.0000	0.0000	0.0000	0.0000	0.0000	0.0000	0.0000	0.0000	0.0000	0.0000	0.0000	0.0000	0.0000	0.0000	0.0000	0.0000	0.0000	0.0000	0.0000	0.0000	0.0000	0.0000	0.0000	0.0000
Dec-14	0.0000	0.0000	0.0000	0.0000	0.0000	0.0000	0.0000	0.0000	0.0000	0.0000	0.0000	0.0000	0.0000	0.0000	0.0000	0.0000	0.0000	0.0000	0.0000	0.0000	0.0000	0.0000	0.0000	0.0000	0.0000







**Figure 97 Split Airport safety performance indicators from 2014 to 2021**  
 Source: Author using Microsoft Excel

## 8.2 Causal modelling of Split Airport organisational and safety performance indicators

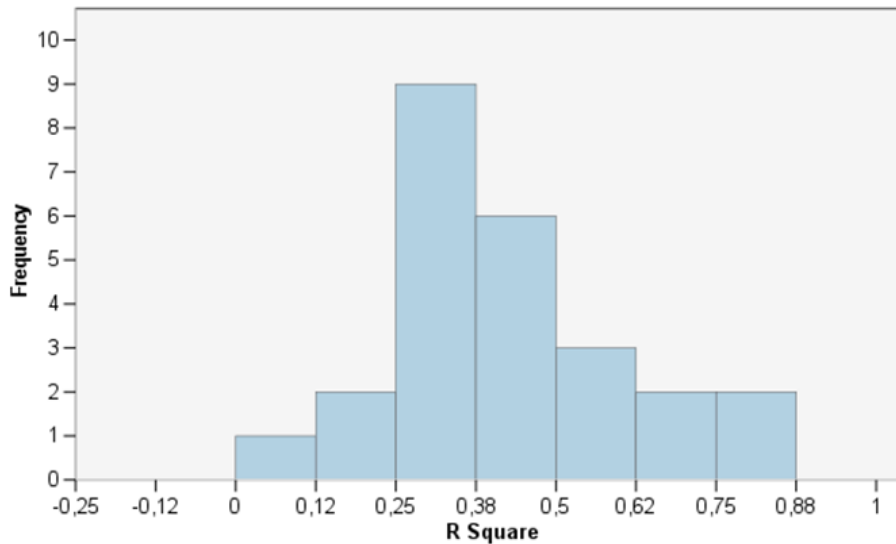
To obtain impact relations between organisational and safety performance indicators, IBM SPSS function „Temporal Causal Modelling” was used. The set-up was made in such way that independent variables are organisational indicators (OIs), i.e., OIs are set to be „inputs” in temporal causal model, and safety performance indicators (SPIs) are dependent and independent variables, i.e., SPIs are set to be „both inputs and targets”. SPI6 model was excluded due to the fact that values are constant, i.e., equal to 0. Table 41 shows fit statistics for top causal models generated for each of 24 safety performance indicators of Split Airport.

**Table 41 Fit statistics for top causal models**

Target Model	Model Quality				
	RMSE	RMSPE	AIC	BIC	R-squared
SPI1	0.25	0.19	-246.11	-213.18	0.34
SPI2	0.11	0.09	-405.98	-373.06	0.10
SPI3	0.30	0.20	-214.40	-181.48	0.55
SPI4	0.16	0.11	-331.97	-299.04	0.48
SPI5	0.57	0.27	-92.14	-59.21	0.29
SPI7	0.12	0.09	-383.16	-350.24	0.42
SPI8	0.41	0.27	-152.52	-119.60	0.26
SPI9	0.24	0.19	-251.50	-218.58	0.36
SPI10	0.50	0.24	-118.04	-85.12	0.26
SPI11	0.14	0.11	-360.38	-327.46	0.25
SPI12	0.16	0.13	-332.74	-299.81	0.32
SPI13	0.21	0.17	-275.34	-242.42	0.44
SPI14	0.64	0.23	-71.76	-38.83	0.45
SPI15	1.92	0.41	133.59	166.51	0.73
SPI16	0.31	0.20	-205.02	-172.09	0.23
SPI17	0.18	0.14	-310.82	-277.90	0.35
SPI18	0.26	0.17	-235.91	-202.98	0.17
SPI19	0.04	0.02	-573.51	-540.58	0.85
SPI20	0.49	0.23	-121.31	-88.39	0.51
SPI21	1.18	0.44	42.76	75.68	0.46
SPI22	0.16	0.12	-331.73	-298.81	0.32
SPI23	0.12	0.08	-376.67	-343.74	0.68
SPI24	1.56	0.54	94.28	127.21	0.52
SPI25	0.30	0.22	-211.95	-179.03	0.45

Source: Author using IBM SPSS Statistics

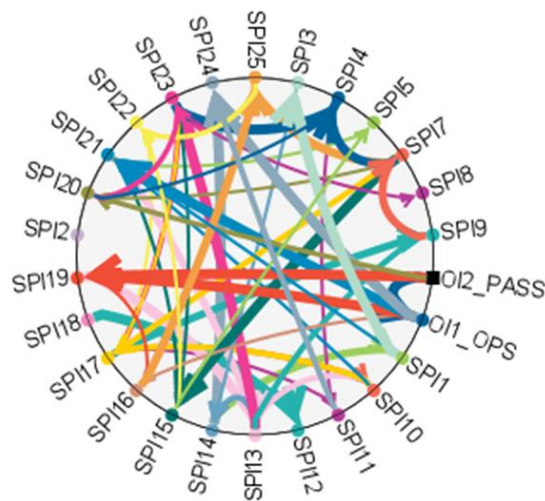
The Figure 98 shows „Overall Model Quality” which shows the distribution of model quality for all the built models (from Table 41). There is a variety of criteria that can be used to do the evaluation (RMSE, RMSPE, AIC, BIC, R-squared). In this case, R-squared is selected, which is the default criterion, and the larger the R-squared value, the better the model. From the Figure 98, the built models show average quality because they have R-squared values in the interval [0.10, 0.88].



**Figure 98 Overall quality of causal model**

*Source: Author using IBM SPSS Statistics*

Figure 99 shows causal model of all relations between organisational indicators (OIs) and safety performance indicators (SPIs) at the Split Airport.

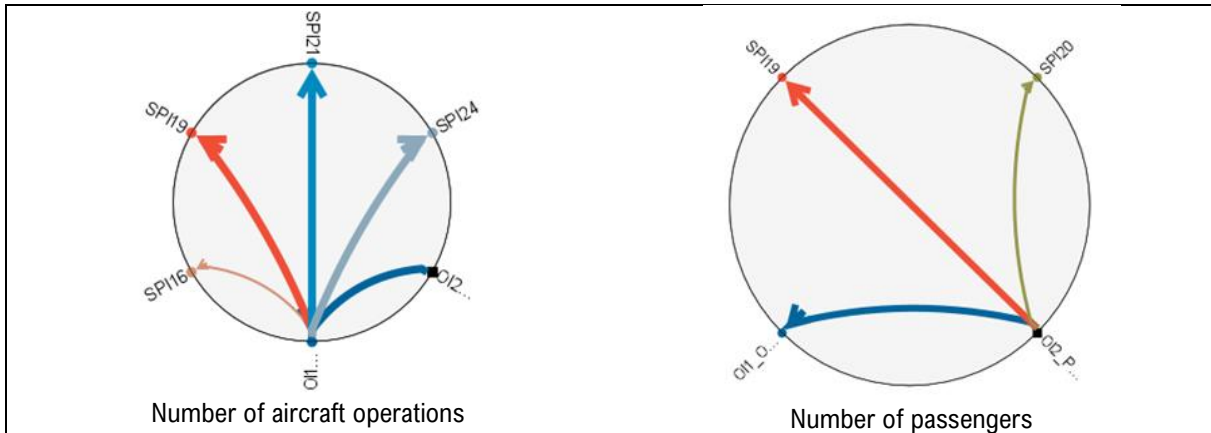


**Figure 99 Causal model of Split Airport organisational and safety performance indicators**

*Source: Author using IBM SPSS Statistics*

Figure 100 shows direct impact of organisational indicators (OIs) on safety performance indicators (SPIs) at the Split Airport.

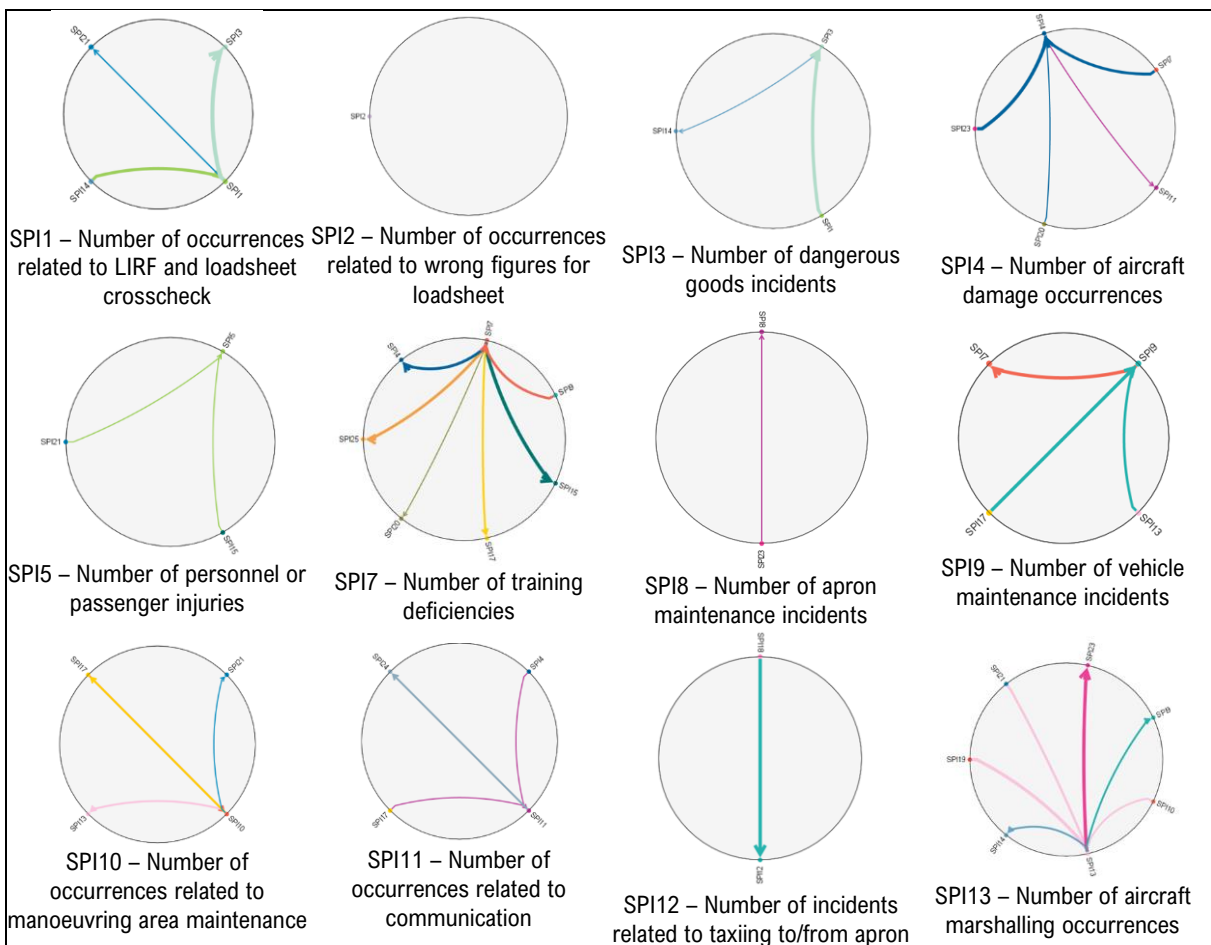


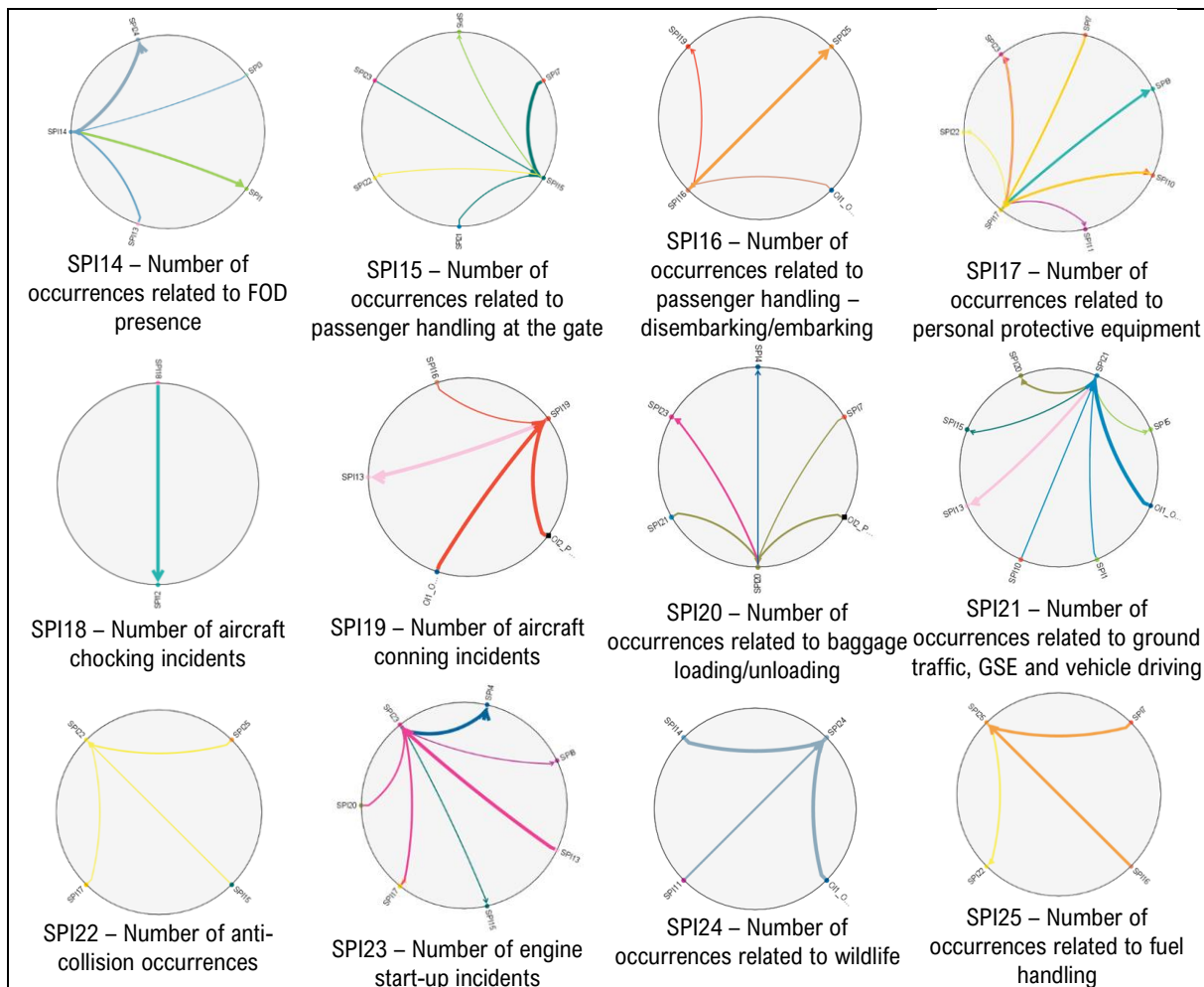


**Figure 100 Direct impact of individual organisational indicators on safety performance indicators**

*Source: Author using IBM SPSS Statistics*

Figure 101 shows causal relations of individual organisational indicators (OIs) and safety performance indicators (SPIs) at the Split Airport.

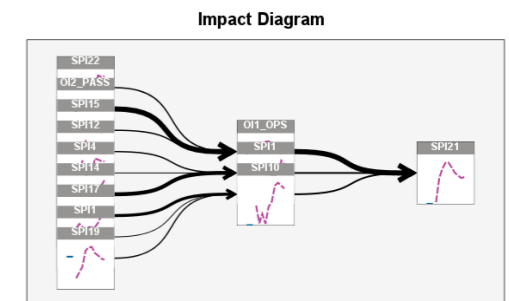
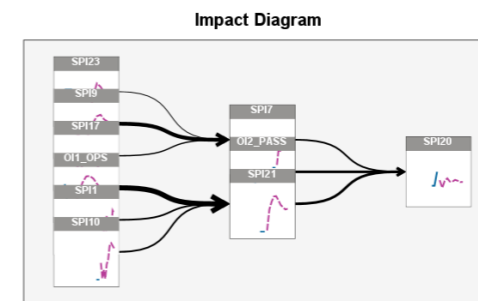
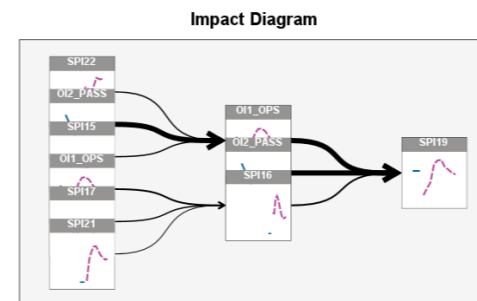
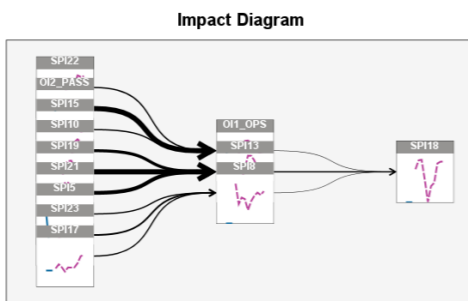
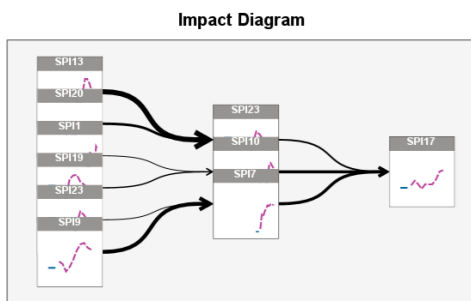
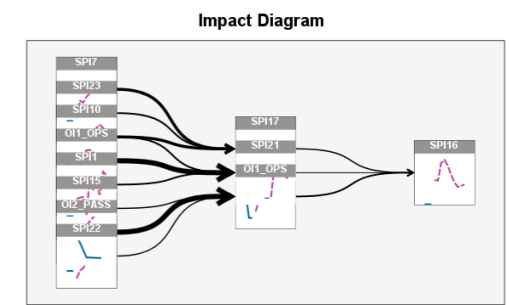
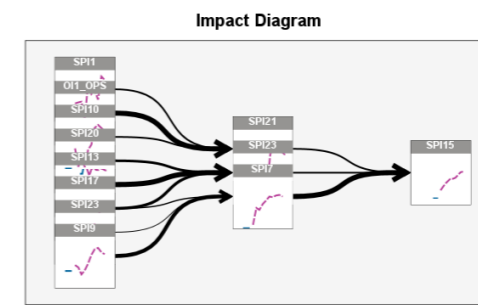
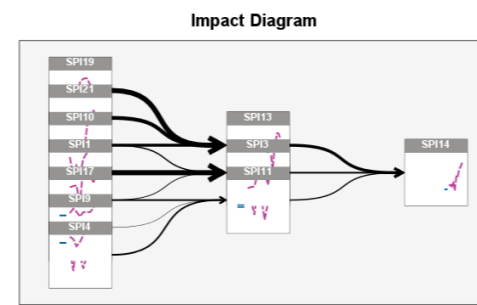
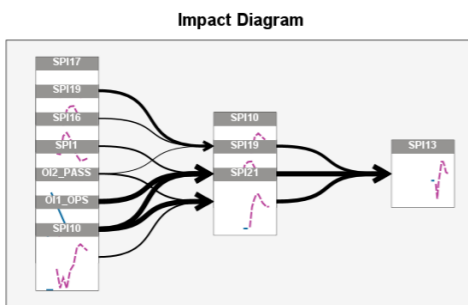
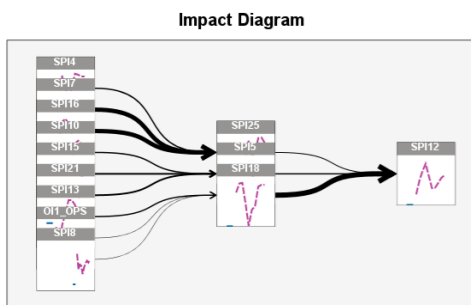
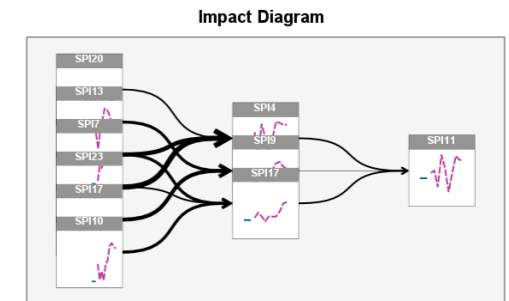
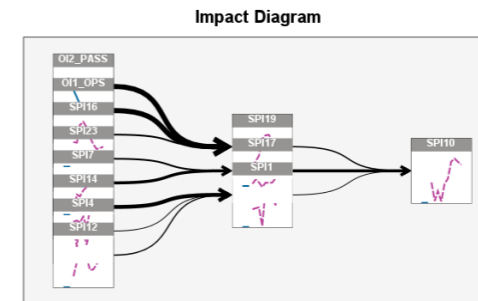
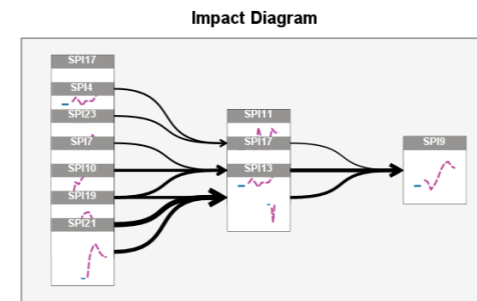
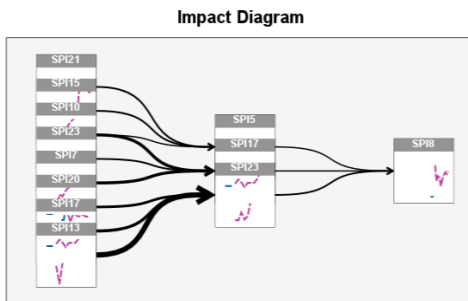
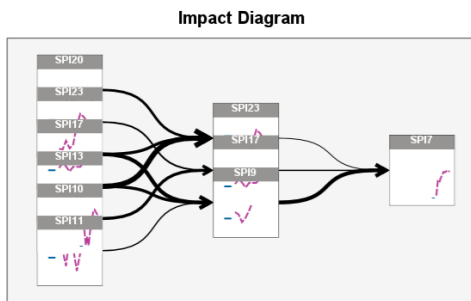
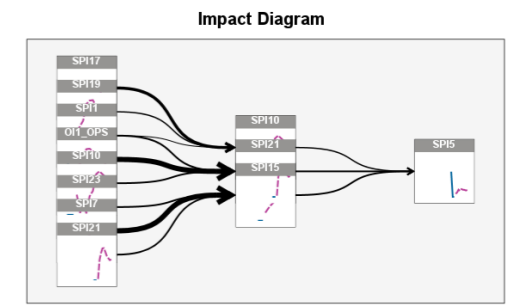
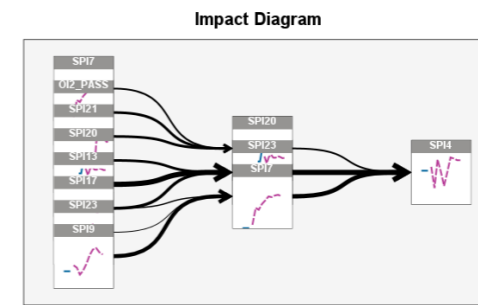
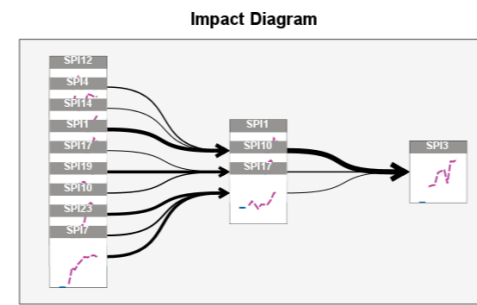
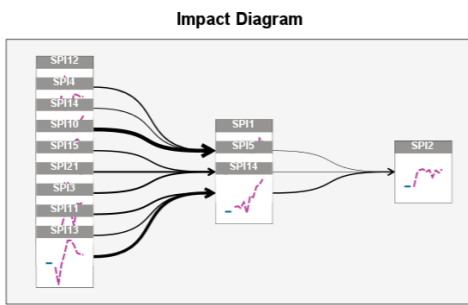
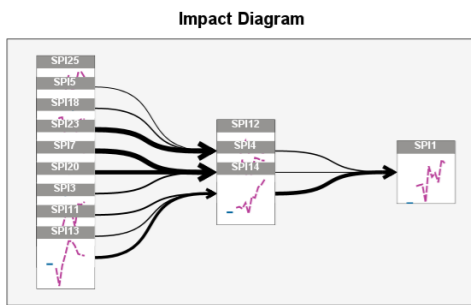
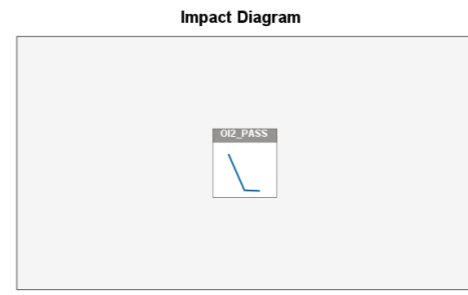
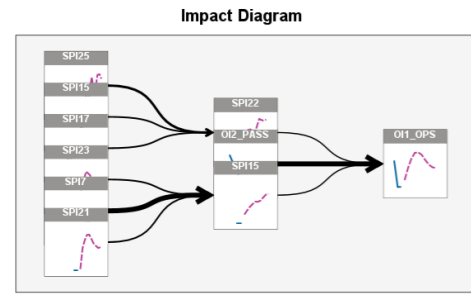




**Figure 101 Impacts of individual safety performance indicators**

*Source: Author using IBM SPSS Statistics*

Next step, after causal model is made, is to examine relations between indicators, and find which impacts the ones in question, hence the causal model shows which of the OIs and SPIs impacts safety performance indicators (SPIs). Figure 102 shows impact diagram of all causes and Figure 103 shows impact diagram of all effects of each indicator.



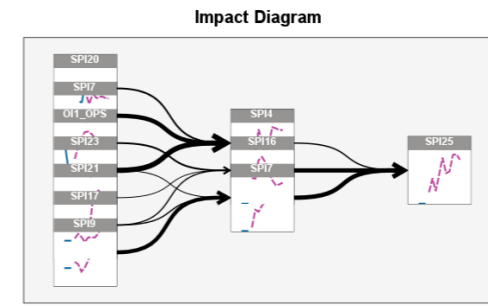
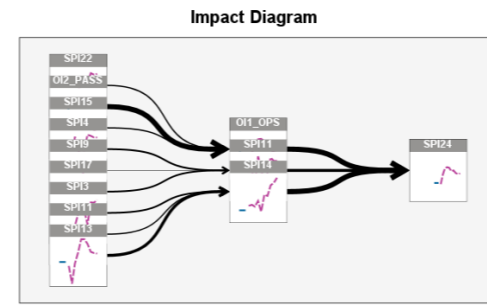
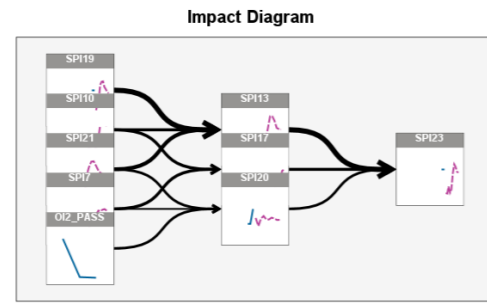
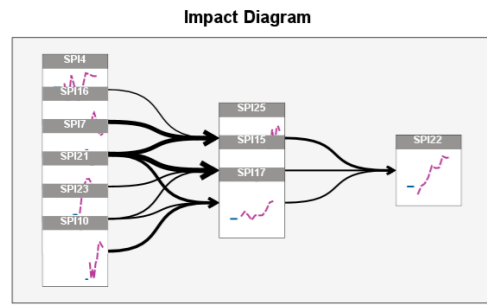
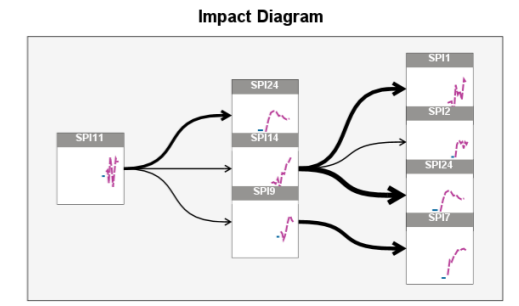
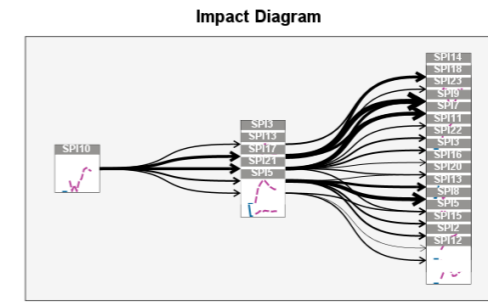
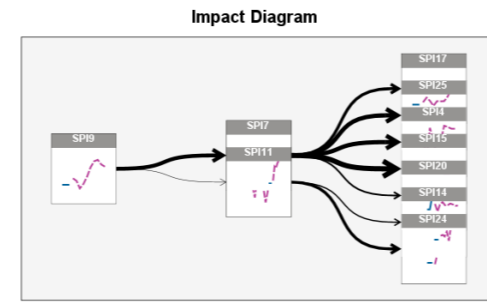
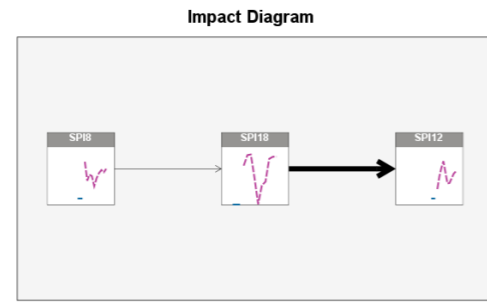
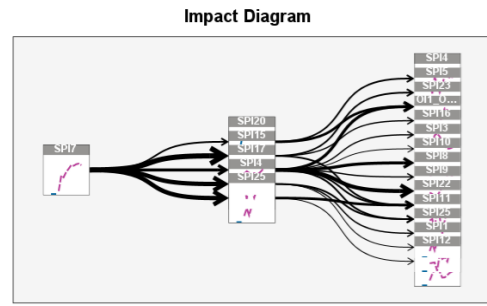
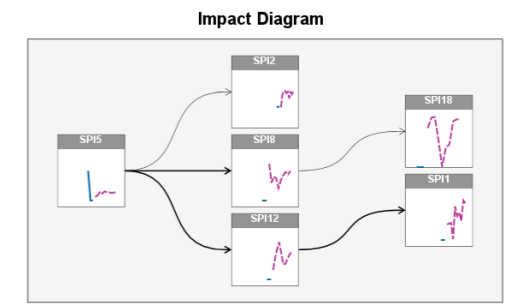
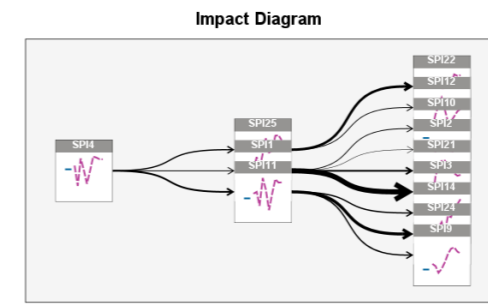
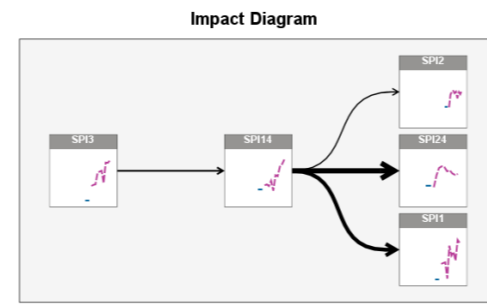
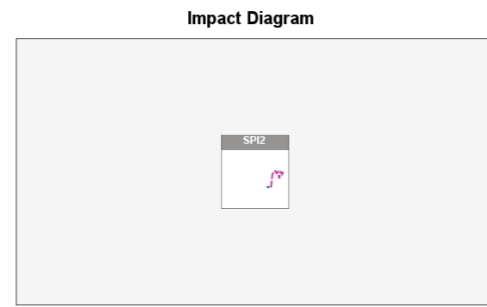
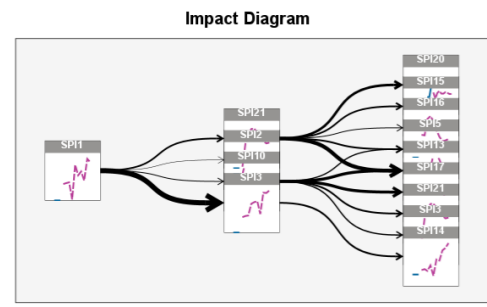
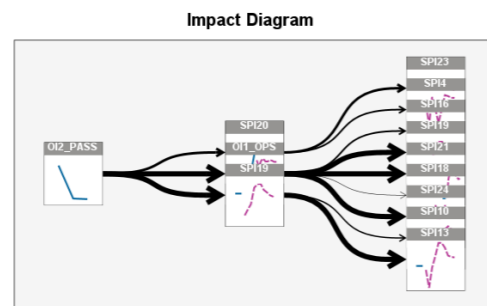
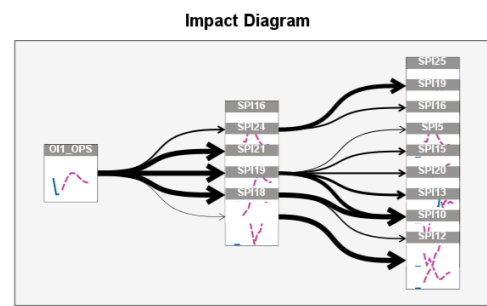


Figure 102 Impact diagrams – causes  
Source: Author using IBM SPSS Statistics



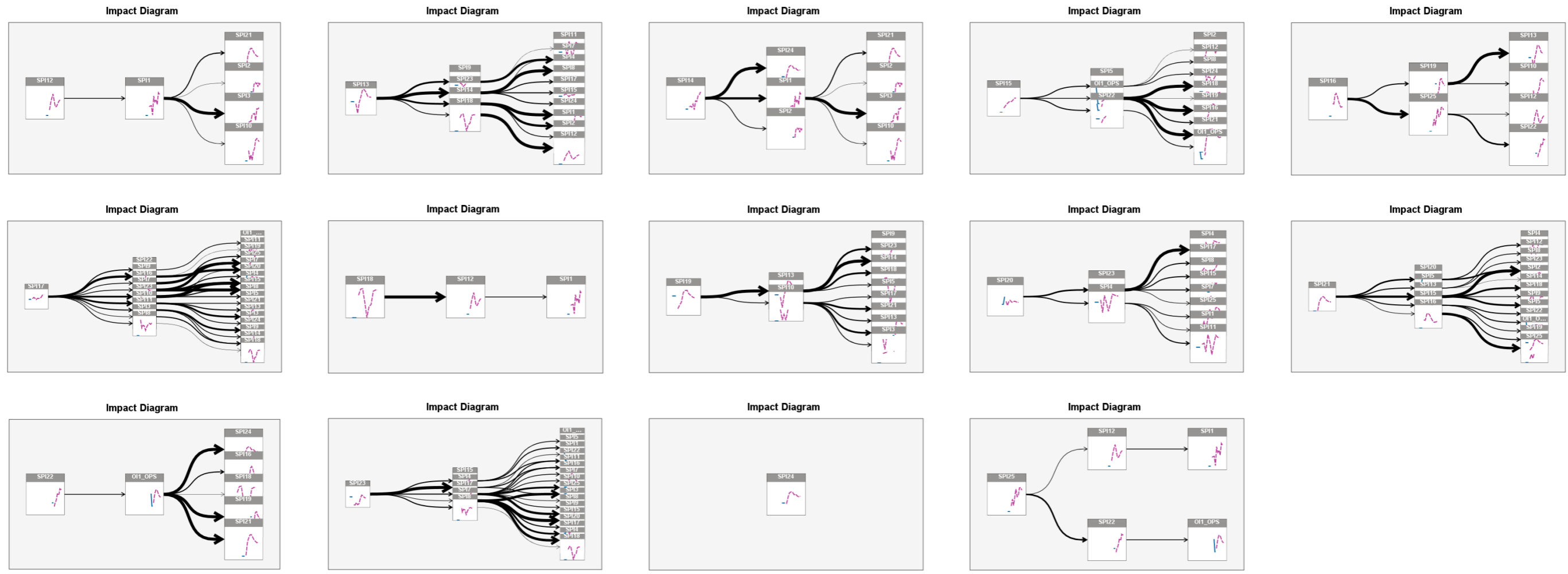


Figure 103 Impact diagrams – effects  
 Source: Author using IBM SPSS Statistics

### 8.3 Outliers and root cause analysis of Split Airport safety performance indicators

As it can be observed that all SPIs are number of occurrences in different segments of airport operations at Split Airport, it has been concluded that extreme numbers of occurrences are in fact outliers of each safety performance indicator dataset, which are in fact, of most interest to any operator because those extreme values (outliers) are exactly the ones that are of most concern to an operator and exactly the ones any operator wishes to mitigate. Outliers can be very low or very high values that do not fit the pattern in the set of values some dataset contains.

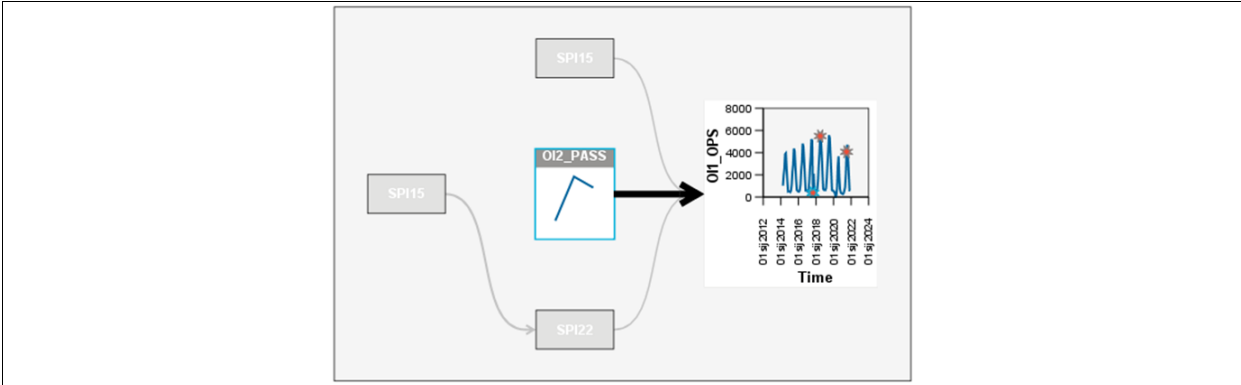
In this case, the upper (higher) values of outliers will be considered because they represent unwanted occurrences in an organisation, i.e., every organisation tends to reduce these events to the 0 or to the minimum acceptable level (usually below safety performance targets – SPTs). Hence, applying root cause analysis of outliers (hazardous events or occurrences in the organisation) can be very useful to determine which indicators caused these extreme values in order to mitigate or prevent them in the future. Finding causes enables organisation to react before hazardous event occurs.

Table 42 shows outlier root cause analysis for organisational indicator OI1 – Number of aircraft operations. Three outliers were detected in September 2017, July 2018, and July 2021. It can be observed that lower number of aircraft operations was due to OI2 – Number of passengers, and OI1 was detected to be higher because of SPI15 – Number of occurrences related to passenger handling at the gate. Figure 104 shows graphically which indicators caused OI1, and points out the strongest cause among them, which is OI2 – Number of passengers.

**Table 42 Outlier root cause analysis for indicator OI1**

Time point	Observed value	Predicted value	Outlier probability	Root causes
Sep 2017	378.00	2,098.40	0.99	OI2_PASS
Jul 2021	4,084.00	2,500.42	0.98	None found
Jul 2018	5.504.00	3,998.48	0.98	SPI15

Source: Author using IBM SPSS Statistics



**Figure 104 Outliers and root causes of indicator OI1**

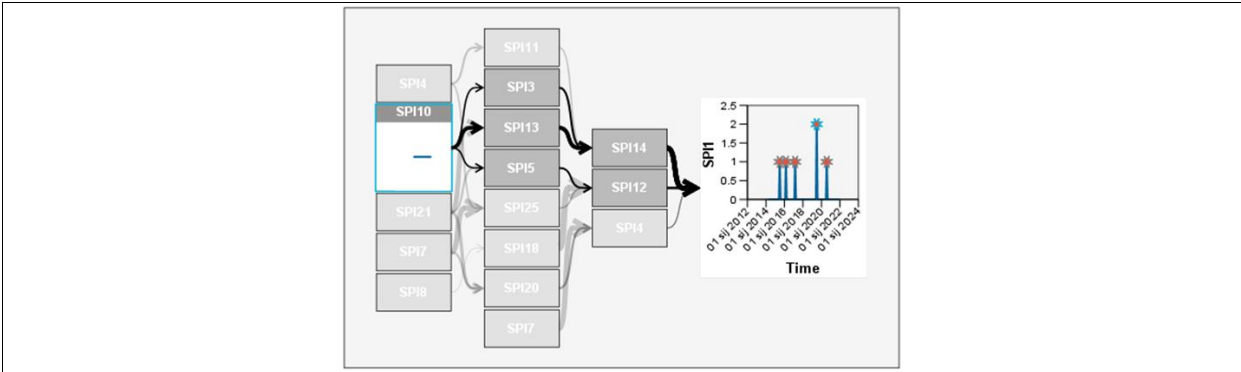
Source: Author using IBM SPSS Statistics

Table 43 shows outlier root cause analysis for safety performance indicator SPI1 – Number of occurrences related to LIRF and loadsheet crosscheck. Five outliers were detected in July 2015, March 2016, March 2017, July 2019, and August 2020. It can be observed that higher SPI1 in July 2015 was due to SPI21 – Number of occurrences related to ground traffic (GSE) and vehicle driving, in March 2016 due to SPI7 – Number of training deficiencies, in March 2017 due to SPI4 – Number of aircraft damage occurrences, in July 2019 due to SPI10 – Number of occurrences related to manoeuvring area maintenance, and in August 2020 due to SPI8 – Number of apron maintenance incidents. Figure 105 shows graphically which indicators caused SPI1, and points out the strongest cause among them, which is SPI10 – Number of occurrences related to manoeuvring area maintenance.

**Table 43 Outlier root cause analysis for indicator SPI1**

Time point	Observed value	Predicted value	Outlier probability	Root causes
Aug 2020	1.00	0.02	1.00	SPI8
Jul 2015	1.00	0.02	1.00	SPI21
Mar 2016	1.00	0.13	1.00	SPI7
Jul 2019	2.00	1.26	1.00	SPI10
Mar 2017	1.00	0.33	0.99	SPI4

Source: Author using IBM SPSS Statistics



**Figure 105 Outliers and root causes of indicator SPI1**

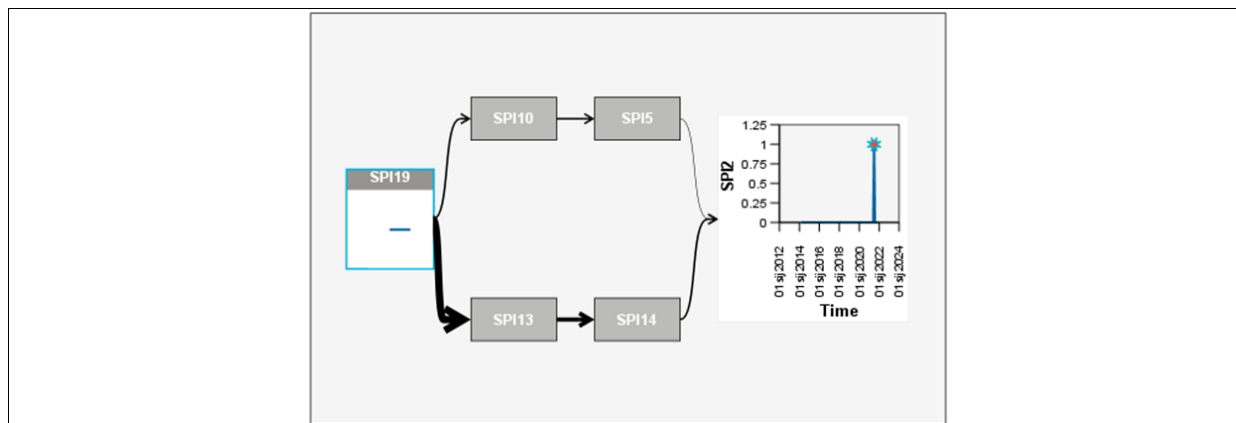
Source: Author using IBM SPSS Statistics

Table 44 shows outlier root cause analysis for safety performance indicator SPI2 – Number of occurrences related to wrong figures for loadsheet. One outlier was detected in July 2021. It can be observed that higher SPI2 was detected because of SPI19 – Number of aircraft conning incidents. Figure 106 shows graphically which indicators caused SPI2, and points out the strongest cause among them, which is SPI19 – Number of aircraft conning incidents.

**Table 44 Outlier root cause analysis for indicator SPI2**

Time point	Observed value	Predicted value	Outlier probability	Root causes
Jul 2021	1.00	0.11	1.00	SPI19

Source: Author using IBM SPSS Statistics



**Figure 106 Outliers and root causes of indicator SPI2**

*Source: Author using IBM SPSS Statistics*

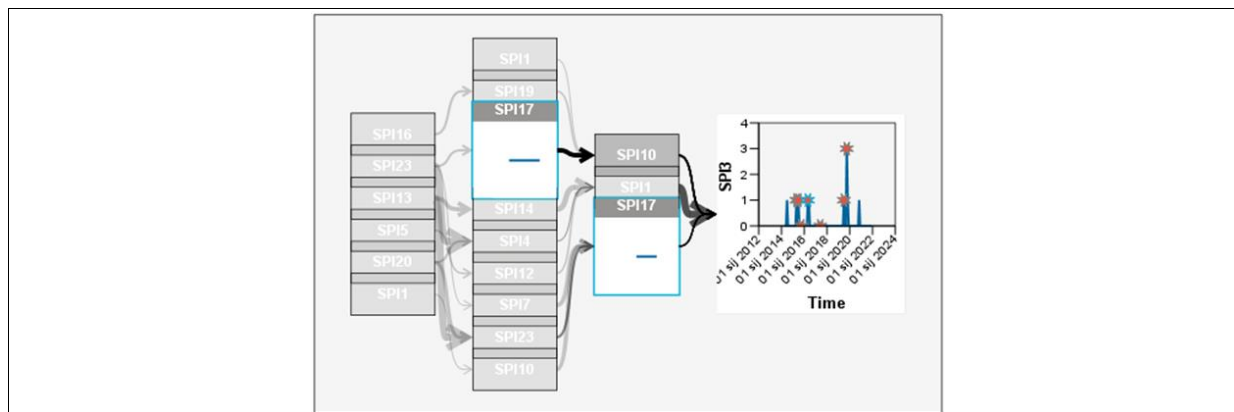
Table 45 shows outlier root cause analysis for safety performance indicator SPI3 – Number of dangerous goods incidents. Five outliers were detected in May 2015, July 2015, May 2016, July 2019, and October 2019. It can be observed that SPI3 was detected to be higher in May 2015 because of SPI15 – Number of occurrences related to passenger handling at the gate, in July 2015 because of SPI23 – Number of engine start-up incidents, in May 2016 because of SPI17 – Number of occurrences related to personal protective equipment, in July 2019 because of SPI1 – Number of occurrences related to LIRF and loadsheet crosscheck, and in October 2019 because of SPI13 – Number of aircraft marshalling occurrences. Figure 107 shows graphically which indicators caused SPI3, and points out the strongest cause among them, which is SPI17 – Number of occurrences related to personal protective equipment.

**Table 45 Outlier root cause analysis for indicator SPI3**

Time point	Observed value	Predicted value	Outlier probability	Root causes
Jun 2017	0.00	1.06	1.00	SPI5
Oct 2019	3.00	2.01	1.00	SPI13
Jul 2015	1.00	0.02	1.00	SPI23
Jul 2019	1.00	0.03	1.00	SPI1
May 2015	1.00	0.03	1.00	SPI16
May 2016	1.00	0.15	1.00	SPI17
Oct 2015	0.00	0.65	0.97	SPI20

*Source: Author using IBM SPSS Statistics*





**Figure 107 Outliers and root causes of indicator SPI3**

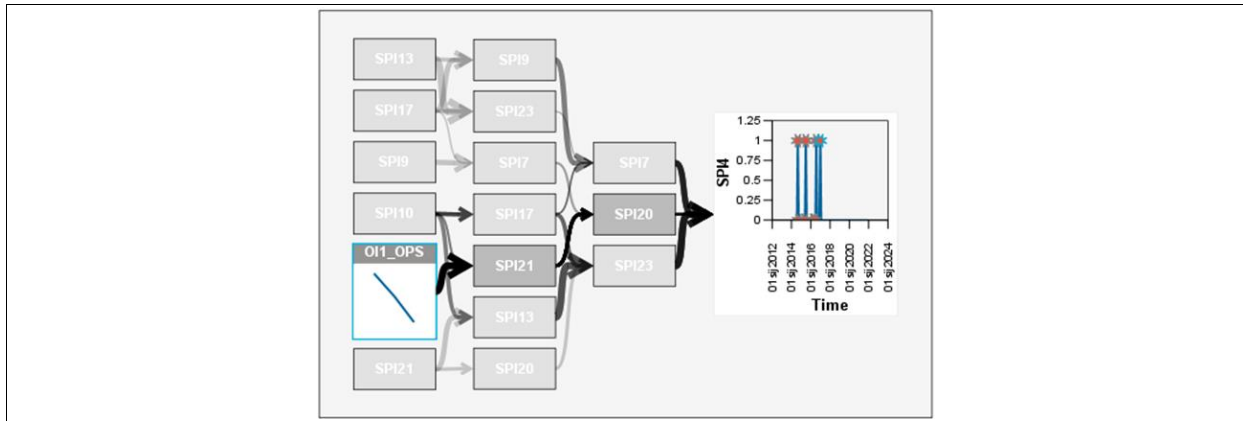
*Source: Author using IBM SPSS Statistics*

Table 46 shows outlier root cause analysis for safety performance indicator SPI4 – Number of aircraft damage occurrences. Four outliers were detected in September 2014, July 2015, August 2016, and January 2017. It can be observed that SPI4 was detected to be higher in September 2014 because of SPI10 – Number of occurrences related to manoeuvring area maintenance, in July 2015 because of SPI13 – Number of aircraft marshalling occurrences, in August 2016 because of SPI10 – Number of occurrences related to manoeuvring area maintenance, and in January 2017 because of OI1 – Number of aircraft operations. Figure 108 shows graphically which indicators caused SPI4, and points out the strongest cause among them, which is OI1 – Number of aircraft operations.

**Table 46 Outlier root cause analysis for indicator SPI4**

Time point	Observed value	Predicted value	Outlier probability	Root causes
Jan 2017	1.00	0.18	1.00	OI1_OPS
Sep 2014	1.00	0.52	1.00	SPI10
Jun 2015	0.00	0.43	0.99	SPI21
Oct 2014	0.00	0.40	0.99	SPI10
Jul 2015	1.00	0.64	0.98	SPI13
Aug 2016	1.00	0.68	0.96	SPI10
Apr 2016	0.00	-0.32	0.96	SPI17
Jun 2016	0.00	0.32	0.96	SPI9

*Source: Author using IBM SPSS Statistics*



**Figure 108 Outliers and root causes of indicator SPI4**

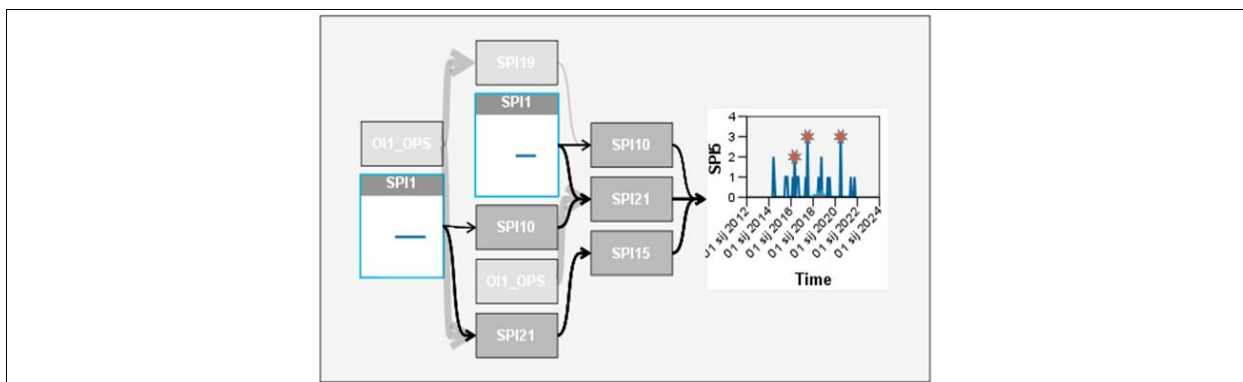
*Source: Author using IBM SPSS Statistics*

Table 47 shows outlier root cause analysis for safety performance indicator SPI5 – Number of personnel or passenger injuries. Three outliers were detected in May 2016, July 2017, and July 2020. It can be observed that SPI5 was detected to be higher in May 2016 because of SPI1 – Number of occurrences related to LIRF and loadsheet crosscheck, in July 2017 because of OI1 – Number of aircraft operations, and in July 2020 because of SPI1 – Number of occurrences related to LIRF and loadsheet crosscheck. Figure 109 shows graphically which indicators caused SPI5, and points out the strongest cause among them, which is SPI1 – Number of occurrences related to LIRF and loadsheet crosscheck.

**Table 47 Outlier root cause analysis for indicator SPI5**

Time point	Observed value	Predicted value	Outlier probability	Root causes
Jul 2020	3.00	0.33	1.00	SPI1
Jul 2017	3.00	1.10	1.00	OI1_OPS
May 2016	2.00	0.41	0.99	SPI1
Aug 2018	0.00	1.15	0.96	SPI1

*Source: Author using IBM SPSS Statistics*



**Figure 109 Outliers and root causes of indicator SPI5**

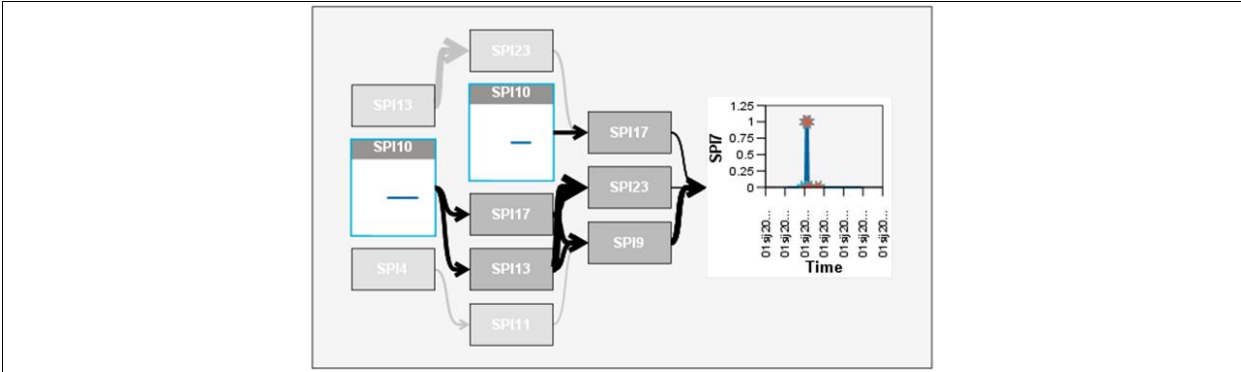
*Source: Author using IBM SPSS Statistics*

Table 48 shows outlier root cause analysis for safety performance indicator SPI7 – Number of training deficiencies. Two outliers were detected in March and July 2016. It can be observed that higher SPI7 was detected in March 2016 because of SPI4 – Number of aircraft damage occurrences. Figure 110 shows graphically which indicators caused SPI7, and points out the strongest cause among them, which is SPI10 – Number of occurrences related to manoeuvring area maintenance.

**Table 48 Outlier root cause analysis for indicator SPI7**

Time point	Observed value	Predicted value	Outlier probability	Root causes
Mar 2016	1.00	0.24	1.00	SPI4
Jul 2016	0.00	0.38	1.00	None found
May 2016	1.00	0.62	1.00	None found
Jun 2017	0.00	0.24	0.95	SPI13
Dec 2015	0.00	0.24	0.95	SPI10

Source: Author using IBM SPSS Statistics



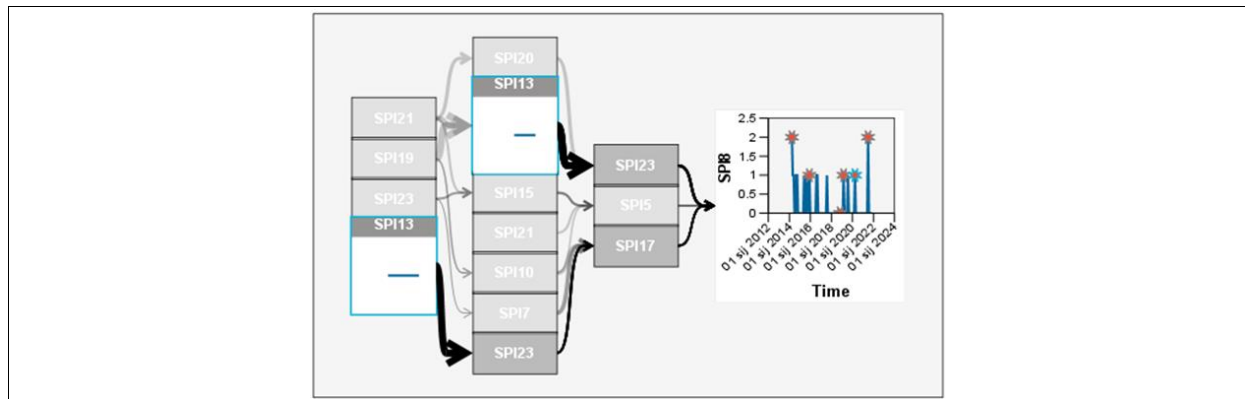
**Figure 110 Outliers and root causes of indicator SPI7**  
 Source: Author using IBM SPSS Statistics

Table 49 shows outlier root cause analysis for safety performance indicator SPI8 – Number of apron maintenance incidents. Five outliers were detected in April 2014, December 2015, March 2019, April 2020, and July 2021. It can be observed that higher SPI8 in December 2015 was due to SPI21 – Number of occurrences related to ground traffic (GSE) and vehicle driving, in March 2019 was due to SPI19 – Number of aircraft conning incidents, in April 2020 was due to SPI13 – Number of aircraft marshalling occurrences, and in July 2021 was due to SPI23 – Number of engine start-up incidents. Figure 111 shows graphically which indicators caused SPI8, and points out the strongest cause among them, which is SPI13 – Number of aircraft marshalling occurrences.

**Table 49 Outlier root cause analysis for indicator SPI8**

Time point	Observed value	Predicted value	Outlier probability	Root causes
Jul 2021	2.00	0.23	1.00	SPI23
Apr 2014	2.00	0.62	1.00	None found
Dec 2015	1.00	0.04	0.98	SPI21
Apr 2020	1.00	0.11	0.97	SPI13
Mar 2019	1.00	0.11	0.97	SPI19
Nov 2018	0.00	0.85	0.96	SPI23

Source: Author using IBM SPSS Statistics



**Figure 111 Outliers and root causes of indicator SPI8**

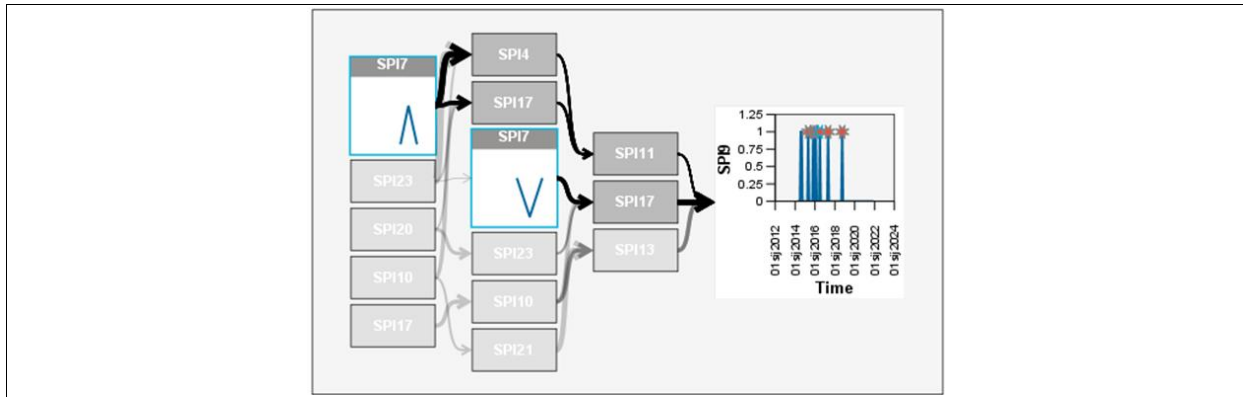
Source: Author using IBM SPSS Statistics

Table 50 shows outlier root cause analysis for safety performance indicator SPI9 – Number of vehicle maintenance incidents. Six outliers were detected in May 2015, November 2015, February 2016, July 2016, May 2017, and October 2018. It can be observed that higher SPI9 in May 2015 was due to SPI17 – Number of occurrences related to personal protective equipment, in November 2015 was due to SPI20 – Number of occurrences related to baggage loading/unloading, in February 2016 was due to SPI7 – Number of training deficiencies, in July 2016 was due to SPI7 – Number of training deficiencies, in May 2017 was due to SPI23 – Number of engine start-up incidents, and October 2018 was due to SPI10 – Number of occurrences related to manoeuvring area maintenance. Figure 112 shows graphically which indicators caused SPI9, and points out the strongest cause among them, which is SPI7 – Number of training deficiencies.

**Table 50 Outlier root cause analysis for indicator SPI9**

Time point	Observed value	Predicted value	Outlier probability	Root causes
May 2017	1.00	0.02	1.00	SPI23
Feb 2016	1.00	0.16	1.00	SPI7
May 2015	1.00	0.26	1.00	SPI17
Jul 2016	1.00	0.30	1.00	SPI7
Oct 2018	1.00	0.48	0.97	SPI10
Nov 2015	1.00	0.49	0.96	SPI20

Source: Author using IBM SPSS Statistics



**Figure 112 Outliers and root causes of indicator SPI9**

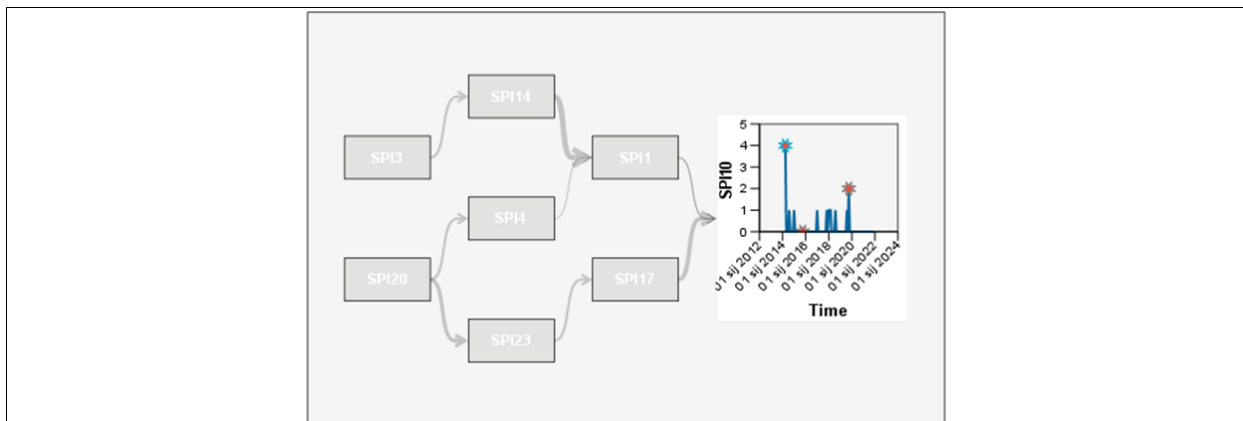
*Source: Author using IBM SPSS Statistics*

Table 51 shows outlier root cause analysis for safety performance indicator SPI10 – Number of occurrences related to manoeuvring area maintenance. Two outliers were detected in April 2014 and October 2019. It can be observed that SPI10 was detected to be higher in October 2019 because of SPI3 – Number of dangerous goods incidents. Figure 113 shows graphically which indicators caused SPI10.

**Table 51 Outlier root cause analysis for indicator SPI10**

Time point	Observed value	Predicted value	Outlier probability	Root causes
Apr 2014	4.00	0.94	1.00	None found
Oct 2015	0.00	1.28	0.99	SPI20
Oct 2019	2.00	0.81	0.98	SPI3

*Source: Author using IBM SPSS Statistics*



**Figure 113 Outliers and root causes of indicator SPI10**

*Source: Author using IBM SPSS Statistics*

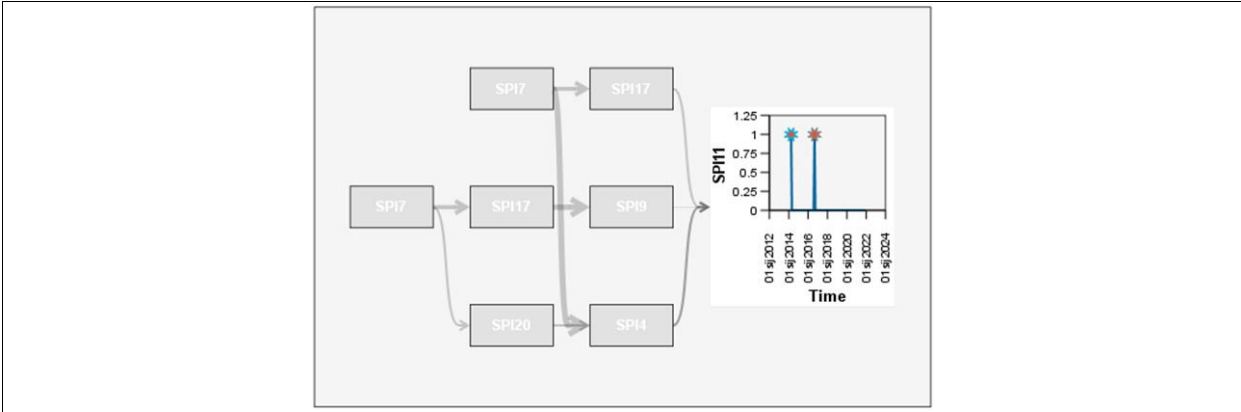
Table 52 shows outlier root cause analysis for safety performance indicator SPI11 – Number of occurrences related to communication. Two outliers were detected in April 2014 and September

2016. It can be observed that higher SPI11 in September 2016 was due to SPI7 – Number of training deficiencies. Figure 114 shows graphically which indicators caused SPI11.

**Table 52 Outlier root cause analysis for indicator SPI11**

Time point	Observed value	Predicted value	Outlier probability	Root causes
Apr 2014	1.00	0.23	1.00	None found
Sep 2016	1.00	0.31	1.00	SPI7

Source: Author using IBM SPSS Statistics



**Figure 114 Outliers and root causes of indicator SPI11**

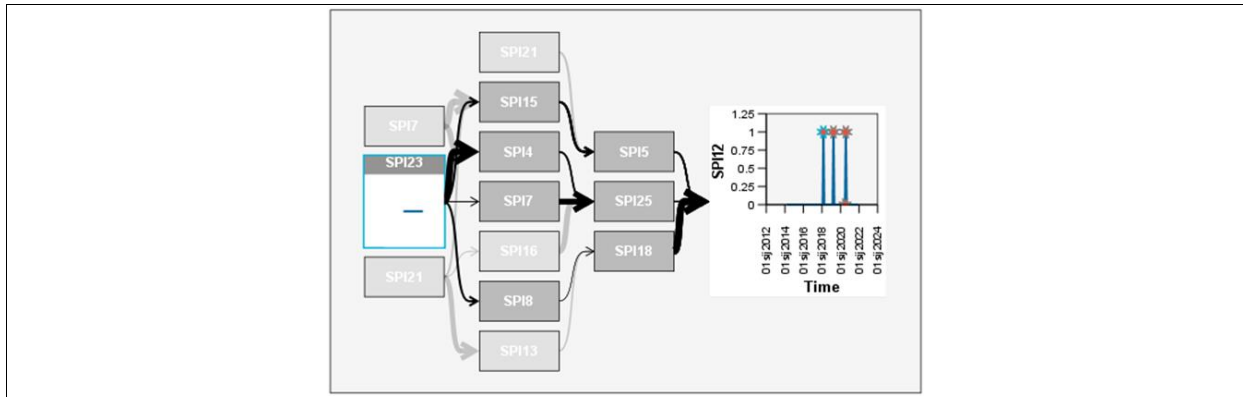
Source: Author using IBM SPSS Statistics

Table 53 shows outlier root cause analysis for safety performance indicator SPI12 – Number of incidents related to taxiing to/from apron. Three outliers were detected in March 2018, April 2019, and August 2020. It can be observed that higher SPI12 in March 2018 was due to SPI23 – Number of engine start-up incidents, in April 2019 was due to SPI7 – Number of training deficiencies, and in August 2020 was due to SPI21 – Number of occurrences related to ground traffic (GSE) and vehicle driving. Figure 115 shows graphically which indicators caused SPI12, and points out the strongest cause among them, which is SPI23 – Number of engine start-up incidents.

**Table 53 Outlier root cause analysis for indicator SPI12**

Time point	Observed value	Predicted value	Outlier probability	Root causes
Apr 2019	1.00	0.01	1.00	SPI7
Aug 2020	1.00	0.40	1.00	SPI21
Mar 2018	1.00	0.62	0.98	SPI23
Jul 2020	0.00	0.32	0.96	SPI8

Source: Author using IBM SPSS Statistics



**Figure 115 Outliers and root causes of indicator SPI12**

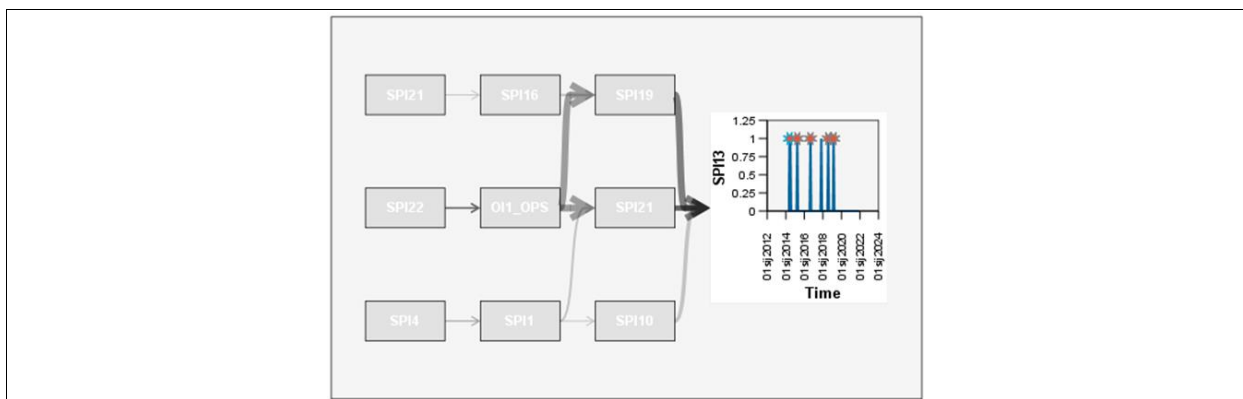
*Source: Author using IBM SPSS Statistics*

Table 54 shows outlier root cause analysis for safety performance indicator SPI13 – Number of aircraft marshalling occurrences. Five outliers were detected in June 2014, April 2015, September 2016, August 2018, and March 2019. It can be observed that SPI13 was detected to be higher in April 2015 because of SPI22 – Number of anti-collision occurrences, in September 2016 because of SPI21 – Number of occurrences related to ground traffic (GSE) and vehicle driving, in August 2018 because of SPI4 – Number of aircraft damage occurrences, and in March 2019 because of SPI22 – Number of anti-collision occurrences. Figure 116 shows graphically which indicators caused SPI13.

**Table 54 Outlier root cause analysis for indicator SPI13**

Time point	Observed value	Predicted value	Outlier probability	Root causes
Apr 2015	1.00	0.11	1.00	SPI22
Sep 2016	1.00	0.15	1.00	SPI21
Mar 2019	1.00	0.20	1.00	SPI22
Aug 2018	1.00	0.54	0.97	SPI4
Jun 2014	1.00	0.55	0.96	None found

*Source: Author using IBM SPSS Statistics*



**Figure 116 Outliers and root causes of indicator SPI13**

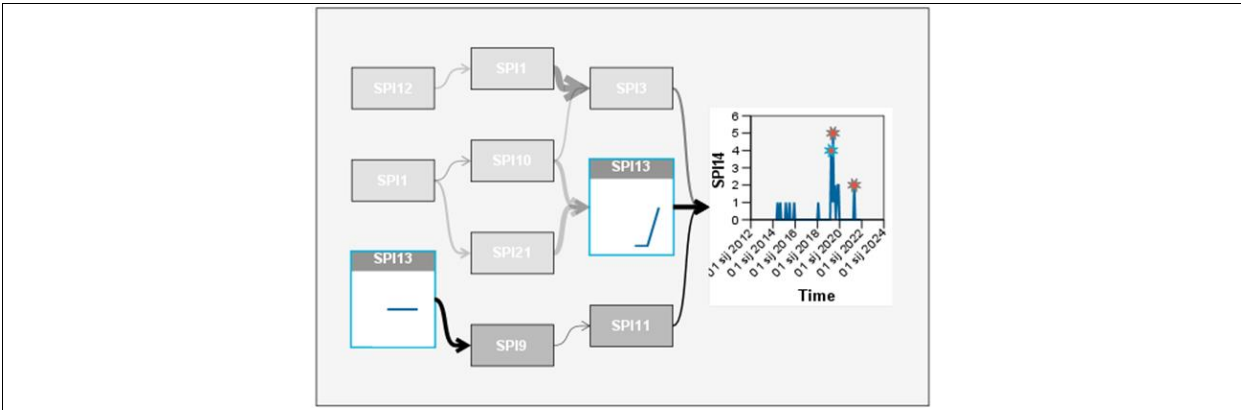
*Source: Author using IBM SPSS Statistics*

Table 55 shows outlier root cause analysis for safety performance indicator SPI14 – Number of occurrences related to FOD presence. Three outliers were detected in April 2019, June 2019, and May 2021. It can be observed that higher SPI14 in April 2019 was due to SPI13 – Number of aircraft marshalling occurrences, in June 2019 was due to SPI12 – Number of incidents related to taxiing to/from apron, and in May 2021 was due to SPI1 – Number of occurrences related to LIRF and loadsheet crosscheck. Figure 117 shows graphically which indicators caused SPI14, and points out the strongest cause among them, which is SPI13 – Number of aircraft marshalling occurrences.

**Table 55 Outlier root cause analysis for indicator SPI14**

Time point	Observed value	Predicted value	Outlier probability	Root causes
Apr 2019	4.00	0.64	1.00	SPI13
Jun 2019	5.00	2.93	1.00	SPI12
May 2021	2.00	0.04	1.00	SPI1

Source: Author using IBM SPSS Statistics



**Figure 117 Outliers and root causes of indicator SPI14**

Source: Author using IBM SPSS Statistics

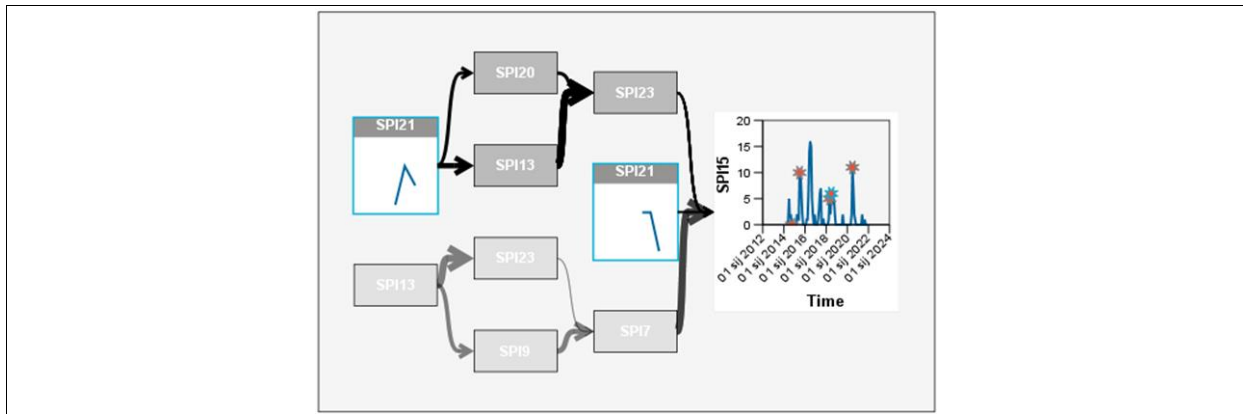
Table 56 shows outlier root cause analysis for safety performance indicator SPI15 – Number of occurrences related to passenger handling at the gate. Four outliers were detected in July 2015, May 2018, July 2018, and July 2020. It can be observed that SPI15 was detected to be higher in July 2015 because of SPI13 – Number of aircraft marshalling occurrences, in May 2018 because of SPI13 – Number of aircraft marshalling occurrences, and in July 2018 because of SPI21 – Number of occurrences related to ground traffic (GSE) and vehicle driving. Figure 118 shows graphically which indicators caused SPI15, and points out the strongest cause among them, which is SPI21 – Number of occurrences related to ground traffic (GSE) and vehicle driving.



**Table 56 Outlier root cause analysis for indicator SPI15**

Time point	Observed value	Predicted value	Outlier probability	Root causes
Jul 2020	11.00	1.78	1.00	None found
Jul 2015	10.00	4.61	0.99	SPI13
Jul 2018	6.00	1.10	0.99	SPI21
Oct 2014	0.00	4.14	0.97	SPI13
May 2018	5.00	1.11	0.96	SPI13

Source: Author using IBM SPSS Statistics



**Figure 118 Outliers and root causes of indicator SPI15**

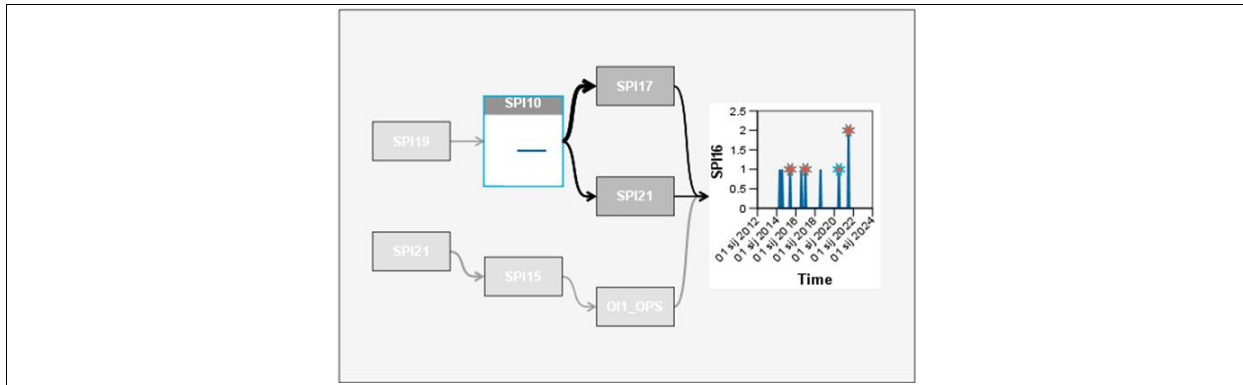
Source: Author using IBM SPSS Statistics

Table 57 shows outlier root cause analysis for safety performance indicator SPI16 – Number of occurrences related to passenger handling – disembarking/embarking. Four outliers were detected in June 2015, January 2017, July 2020, and July 2021. It can be observed that higher SPI16 in June 2015 was due to SPI21 – Number of occurrences related to ground traffic (GSE) and vehicle driving, January 2017 was due to SPI19 – Number of aircraft conning incidents, July 2020 was due to SPI10 – Number of occurrences related to manoeuvring area maintenance, and July 2021 was due to SPI21 – Number of occurrences related to ground traffic (GSE) and vehicle driving. Figure 119 shows graphically which indicators caused SPI16, and points out the strongest cause among them, which is SPI10 – Number of occurrences related to manoeuvring area maintenance.

**Table 57 Outlier root cause analysis for indicator SPI16**

Time point	Observed value	Predicted value	Outlier probability	Root causes
Jul 2021	2.00	0.29	1.00	SPI21
Jan 2017	1.00	0.08	1.00	SPI19
Jul 2020	1.00	0.11	1.00	SPI10
Jun 2015	1.00	0.22	0.99	SPI21

Source: Author using IBM SPSS Statistics



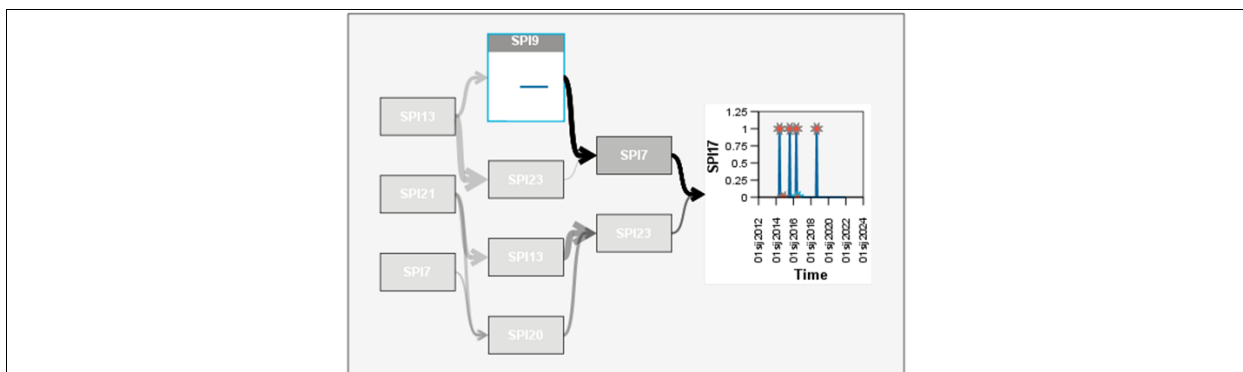
**Figure 119 Outliers and root causes of indicator SPI16**  
 Source: Author using IBM SPSS Statistics

Table 58 shows outlier root cause analysis for safety performance indicator SPI17 – Number of occurrences related to personal protective equipment. Four outliers were detected in June 2014, August 2015, May 2016, and September 2018. It can be observed that higher SPI17 in August 2015 was due to SPI13 – Number of aircraft marshalling occurrences, in May 2016 was due to SPI9 – Number of vehicle maintenance incidents, and in September 2018 was due to SPI7 – Number of training deficiencies. Figure 120 shows graphically which indicators caused SPI17, and points out the strongest cause among them, which is SPI9 – Number of vehicle maintenance incidents.

**Table 58 Outlier root cause analysis for indicator SPI17**

Time point	Observed value	Predicted value	Outlier probability	Root causes
Sep 2018	1.00	0.04	1.00	SPI7
Aug 2015	1.00	0.38	1.00	SPI13
Jun 2014	1.00	0.54	0.99	None found
May 2016	1.00	0.56	0.99	SPI9
Jul 2016	0.00	0.44	0.99	SPI9
Nov 2014	0.00	0.36	0.96	SPI21

Source: Author using IBM SPSS Statistics



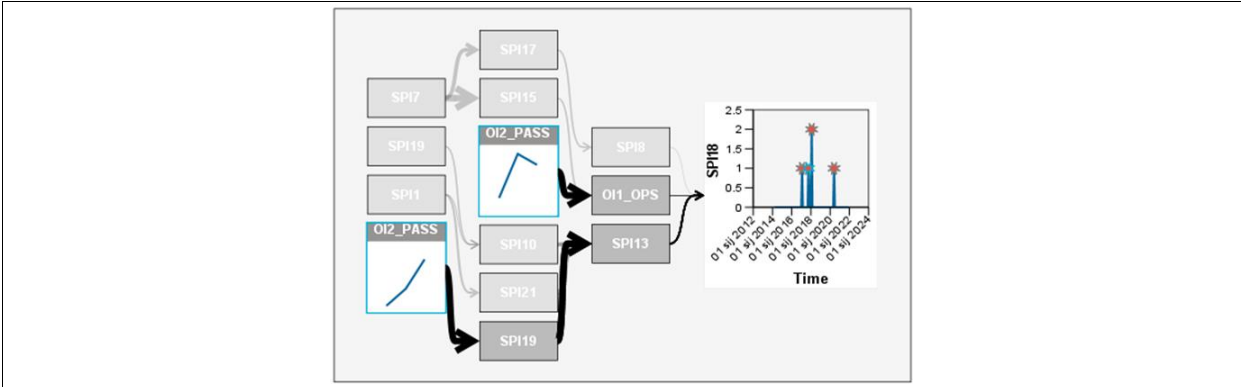
**Figure 120 Outliers and root causes of indicator SPI17**  
 Source: Author using IBM SPSS Statistics

Table 59 shows outlier root cause analysis for safety performance indicator SPI18 – Number of aircraft chocking incidents. Four outliers were detected in February 2017, October 2017, February 2018, and June 2020. It can be observed that SPI18 was detected to be higher in February 2017 because of SPI1 – Number of occurrences related to LIRF and loadsheet crosscheck, in October 2017 because of OI2 – Number of passengers, in February 2018 because of SPI19 – Number of aircraft conning incidents, and in June 2020 because of SPI7 – Number of training deficiencies. Figure 121 shows graphically which indicators are related to SPI18, and points out the strongest relation, which is OI2 – Number of passengers.

**Table 59 Outlier root cause analysis for indicator SPI18**

Time point	Observed value	Predicted value	Outlier probability	Root causes
Feb 2018	2.00	0.40	1.00	SPI19
Feb 2017	1.00	0.10	1.00	SPI1
Jun 2020	1.00	0.21	1.00	SPI7
Oct 2017	1.00	0.32	0.99	OI2_PASS

Source: Author using IBM SPSS Statistics



**Figure 121 Outliers and root causes of indicator SPI18**

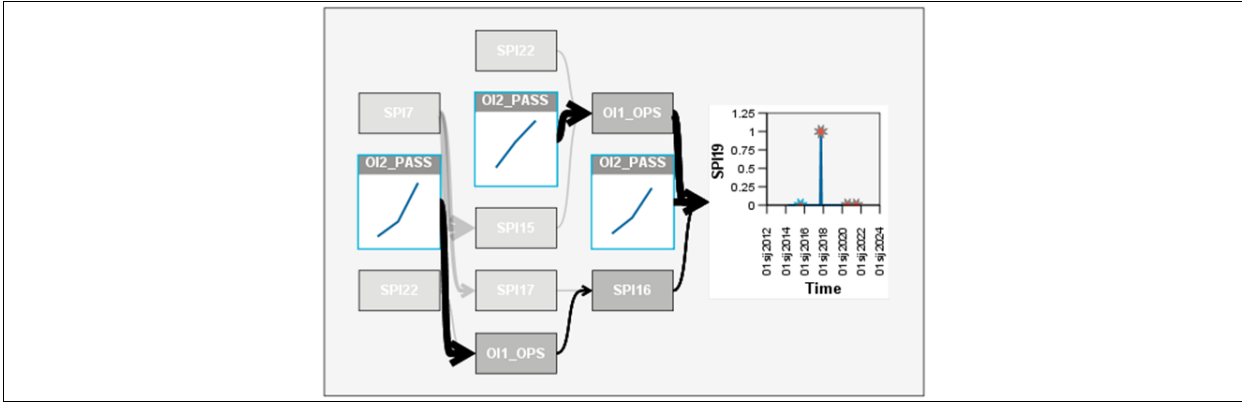
Source: Author using IBM SPSS Statistics

Table 60 shows outlier root cause analysis for safety performance indicator SPI19 – Number of aircraft conning incidents. One outlier was detected in October 2017. It can be observed that higher SPI19 in October 2017 was due to OI2 – Number of passengers. Figure 122 shows graphically which indicators caused SPI19, and points out the strongest cause among them, which is OI2 – Number of passengers.

**Table 60 Outlier root cause analysis for indicator SPI19**

Time point	Observed value	Predicted value	Outlier probability	Root causes
Oct 2017	1.00	0.85	1.00	OI2_PASS
Jul 2021	0.00	-0.13	1.00	SPI7
Aug 2020	0.00	-0.11	0.99	SPI22
Aug 2015	0.00	-0.09	0.96	OI2_PASS

Source: Author using IBM SPSS Statistics



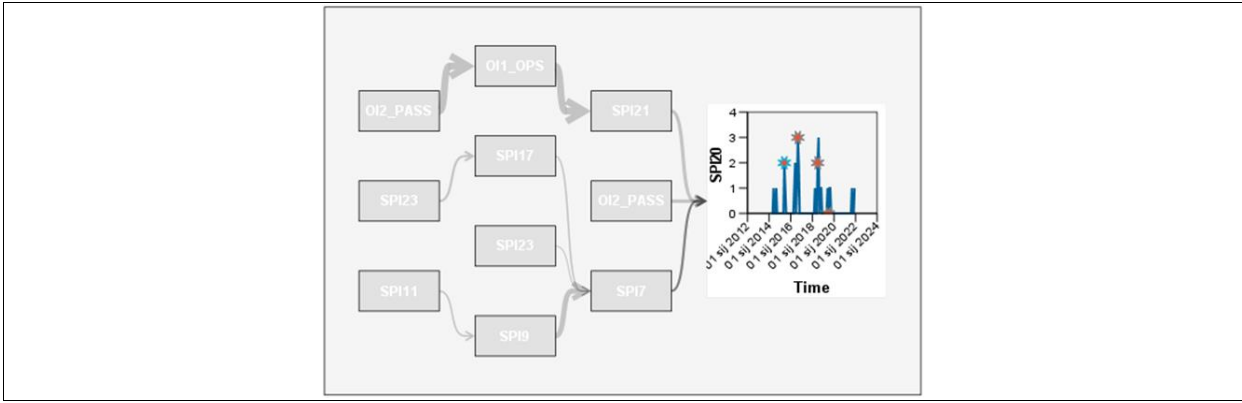
**Figure 122 Outliers and root causes of indicator SPI19**  
*Source: Author using IBM SPSS Statistics*

Table 61 shows outlier root cause analysis for safety performance indicator SPI20 – Number of occurrences related to baggage loading/unloading. Three outliers were detected in June 2015, September 2016, and July 2018. It can be observed that SPI20 was detected to be higher in September 2016 because of SPI11 – Number of occurrences related to communication, and in July 2018 because of SPI23 - Number of engine start-up incidents. Figure 123 shows graphically which indicators caused SPI20.

**Table 61 Outlier root cause analysis for indicator SPI20**

Time point	Observed value	Predicted value	Outlier probability	Root causes
Jun 2015	2.00	0.18	1.00	None found
Sep 2016	3.00	1.50	1.00	SPI11
Jul 2018	2.00	0.85	0.98	SPI23
Jul 2019	0.00	1.02	0.96	OI2_PASS

*Source: Author using IBM SPSS Statistics*



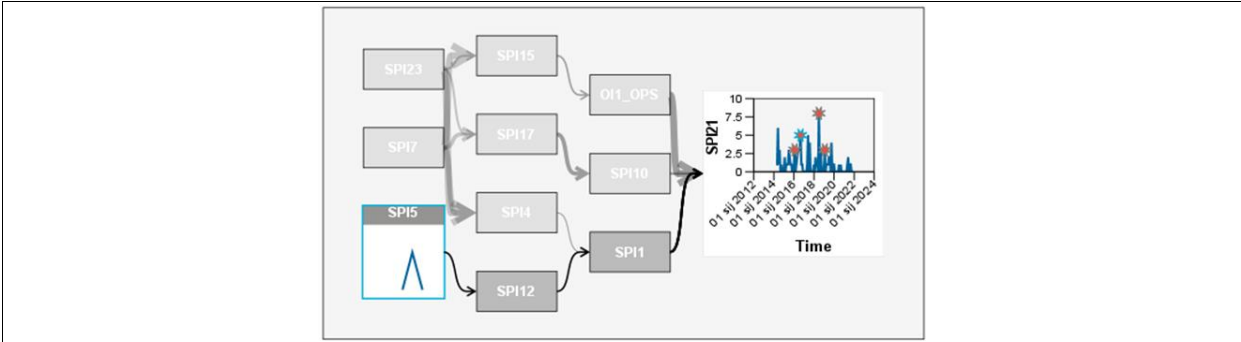
**Figure 123 Outliers and root causes of indicator SPI20**  
*Source: Author using IBM SPSS Statistics*

Table 62 shows outlier root cause analysis for safety performance indicator SPI21 – Number of occurrences related to ground traffic (GSE) and vehicle driving. Four outliers were detected in February 2016, September 2016, July 2018, and February 2019. It can be observed that SPI21 was detected to be higher in February 2016 because of SPI23 – Number of engine start-up incidents, in September 2016 because of SPI5 – Number of personnel or passenger injuries, and in July 2018 because of SPI7 – Number of training deficiencies. Figure 124 shows graphically which indicators caused SPI21, and points out the strongest cause among them, which is SPI5 – Number of personnel or passenger injuries.

**Table 62 Outlier root cause analysis for indicator SPI21**

Time point	Observed value	Predicted value	Outlier probability	Root causes
Jul 2018	8.00	2.37	1.00	SPI7
Sep 2016	5.00	1.92	0.99	SPI5
Feb 2016	3.00	0.34	0.98	SPI23
Feb 2019	3.00	0.58	0.96	None found

Source: Author using IBM SPSS Statistics



**Figure 124 Outliers and root causes of indicator SPI21**

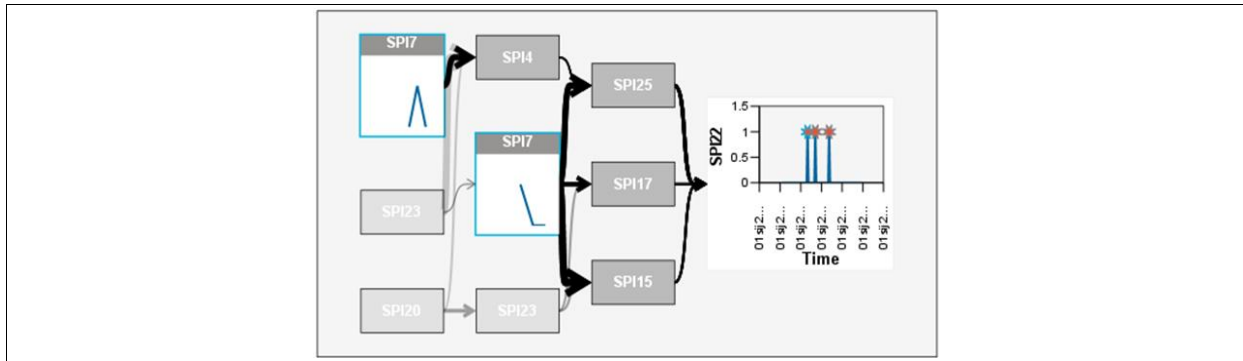
Source: Author using IBM SPSS Statistics

Table 63 shows outlier root cause analysis for safety performance indicator SPI22 – Number of anti-collision occurrences. Three outliers were detected in September 2016, June 2017, and October 2018. It can be observed that higher SPI22 was detected in September 2016 because of SPI7 – Number of training deficiencies, in June 2017 because of SPI20 – Number of occurrences related to baggage loading/unloading, and in October 2018 because of SPI23 – Number of engine start-up incidents. Figure 125 shows graphically which indicators caused SPI22, and points out the strongest cause among them, which is SPI7 – Number of training deficiencies.

**Table 63 Outlier root cause analysis for indicator SPI22**

Time point	Observed value	Predicted value	Outlier probability	Root causes
Jun 2017	1.00	0.17	1.00	SPI20
Oct 2018	1.00	0.32	1.00	SPI23
Sep 2016	1.00	0.52	1.00	SPI7

Source: Author using IBM SPSS Statistics



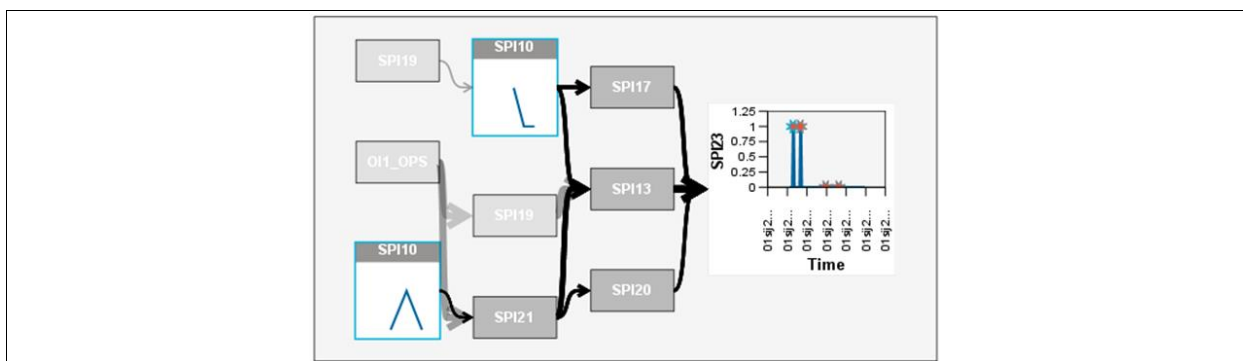
**Figure 125 Outliers and root causes of indicator SPI22**  
 Source: Author using IBM SPSS Statistics

Table 64 shows outlier root cause analysis for safety performance indicator SPI23 – Number of engine start-up incidents. Two outliers were detected in August 2014 and May 2015. It can be observed that higher SPI23 in August 2014 was due to SPI10 – Number of occurrences related to manoeuvring area maintenance, and in May 2015 was also due to SPI10 – Number of occurrences related to manoeuvring area maintenance. Figure 126 shows graphically which indicators caused SPI23, and points out the strongest cause among them, which is SPI10 – Number of occurrences related to manoeuvring area maintenance.

**Table 64 Outlier root cause analysis for indicator SPI23**

Time point	Observed value	Predicted value	Outlier probability	Root causes
May 2015	1.00	0.33	1.00	SPI10
Apr 2019	0.00	0.33	0.99	SPI19
Dec 2017	0.00	0.33	0.99	OI1_OPS
Aug 2014	1.00	0.72	0.97	SPI10

Source: Author using IBM SPSS Statistics



**Figure 126 Outliers and root causes of indicator SPI23**  
 Source: Author using IBM SPSS Statistics

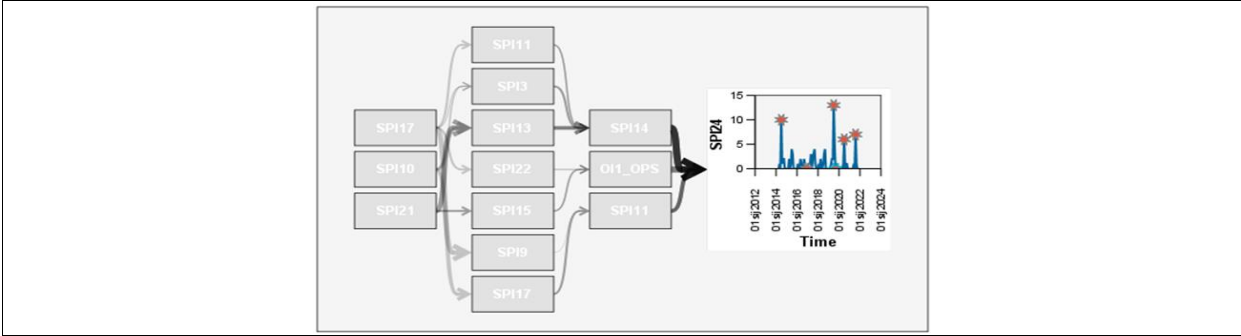
Table 65 shows outlier root cause analysis for safety performance indicator SPI24 – Number of occurrences related to wildlife. Four outliers were detected in July 2014, July 2019, July 2020,

and August 2021. It can be observed that higher SPI24 in July 2014 can be related to SPI11 – Number of occurrences related to communication, in July 2019 can be related to SPI21 – Number of occurrences related to ground traffic (GSE) and vehicle driving, in July 2020 can be related to SPI17 – Number of occurrences related to personal protective equipment, and in August 2021 can be related to SPI21 – Number of occurrences related to ground traffic (GSE) and vehicle driving. Figure 127 shows graphically which indicators are in relation with SPI24.

**Table 65 Outlier root cause analysis for indicator SPI24**

Time point	Observed value	Predicted value	Outlier probability	Root causes
Jul 2020	6.00	0.59	1.00	SPI17
Jul 2019	13.00	8.33	1.00	SPI21
Aug 2021	7.00	3.48	0.98	SPI21
Dec 2016	0.00	3.50	0.98	SPI10
Jul 2014	10.00	6.50	0.98	SPI11
Sep 2019	0.00	3.27	0.96	None found

Source: Author using IBM SPSS Statistics



**Figure 127 Outliers and root causes of indicator SPI24**

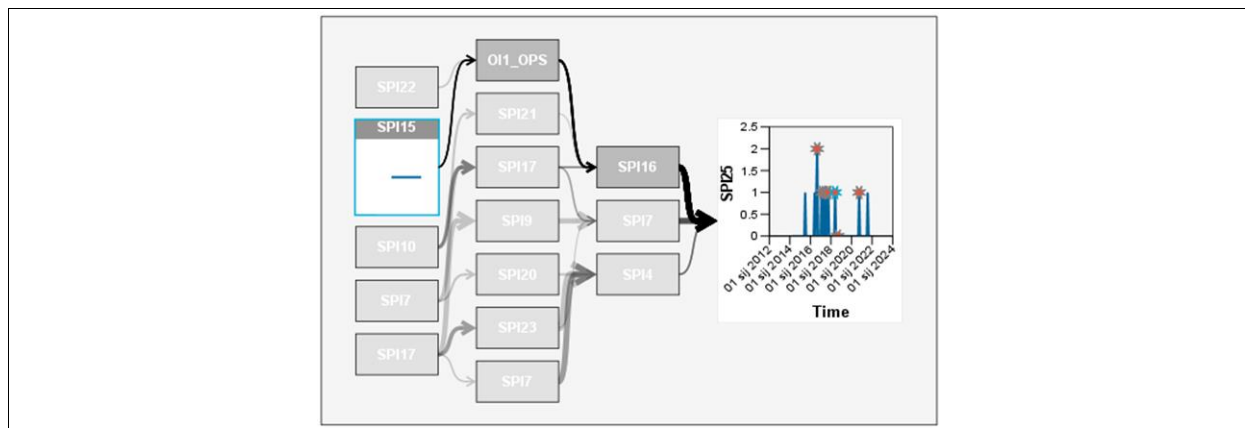
Source: Author using IBM SPSS Statistics

Table 66 shows outlier root cause analysis for safety performance indicator SPI25 – Number of occurrences related to fuel handling. Seven outliers were detected in September 2016, March 2017, June 2017, September 2017, October 2017, June 2018, and October 2020. It can be observed that higher SPI25 in September 2016 was due to SPI17 – Number of occurrences related to personal protective equipment, in March 2017 was due to SPI10 – Number of occurrences related to manoeuvring area maintenance, in June 2017 was due to SPI7 – Number of training deficiencies, in September 2017 was due to SPI16 – Number of occurrences related to passenger handling – disembarking/embarking, in June 2018 was due to SPI15 – Number of occurrences related to passenger handling at the gate, and in October 2020 was due to SPI15 – Number of occurrences related to passenger handling at the gate. Figure 128 shows graphically which indicators caused SPI25, and points out the strongest cause among them, which is SPI15 – Number of occurrences related to passenger handling at the gate.

**Table 66 Outlier root cause analysis for indicator SPI25**

Time point	Observed value	Predicted value	Outlier probability	Root causes
Jun 2018	1.00	0.03	1.00	SPI15
Oct 2020	1.00	0.15	1.00	SPI15
Sep 2017	1.00	0.23	0.99	SPI16
Jun 2017	1.00	0.23	0.99	SPI7
Oct 2017	1.00	0.26	0.99	None found
Mar 2017	1.00	0.27	0.99	SPI10
Sep 2016	2.00	1.28	0.98	SPI17
Sep 2018	0.00	0.61	0.96	SPI22

Source: Author using IBM SPSS Statistics



**Figure 128 Outliers and root causes of indicator SPI25**

Source: Author using IBM SPSS Statistics

Next Table 67 shows events occurring over the observed time period from January 2014 to December 2021. It can be observed how previous events that occurred impact the following, hence the connections can be made between occurrences.

Figure 129 shows graphically events occurring over the observed time period from January 2014 to December 2021. Figure shows all events (outliers) and their causes (the events that influenced them).

Figure 130 shows graphically events occurring over the observed time period from January 2014 to December 2021, caused by safety performance indicator SPI10 – Number of occurrences related to manoeuvring area maintenance, i.e., by events (incidents) related to manoeuvring area maintenance. It can be observed that events related to manoeuvring area maintenance (SPI10) effected events related to LIRF and loadsheet crosscheck (SPI1), events related to aircraft damage (SPI4), events related to vehicle maintenance (SPI9), events related to engine start-up (SPI23), and events related to fuel handling (SPI25), etc. Hence, due to this analysis it can be concluded that introducing mitigating measures related to manoeuvring area maintenance will positively reduce probability of adverse events in LIRF and loadsheet crosscheck procedures, in vehicle maintenance, reduce probability of aircraft damage or events related to engine start-up and fuel handling.



**Table 67 Outliers and root causes for Split Airport safety performance indicators over timeline**

Time point	SPIs	Outliers (number of occurrences)	Root causes	Time point	SPIs	Outliers (number of occurrences)	Root causes	Time point	SPIs	Outliers (number of occurrences)	Root causes
Apr-14	SPI8	2	Unknown	Jul-16	SPI9	1	SPI7	Sep-18	SPI17	1	SPI7
Apr-14	SPI10	4	Unknown	Aug-16	SPI4	1	SPI10	Oct-18	SPI9	1	SPI10
Apr-14	SPI11	1	Unknown	Sep-16	SPI11	1	SPI7	Oct-18	SPI22	1	SPI23
Jun-14	SPI13	1	Unknown	Sep-16	SPI13	1	SPI21	Feb-19	SPI21	3	Unknown
Jun-14	SPI17	1	Unknown	Sep-16	SPI20	3	SPI11	Mar-19	SPI8	1	SPI19
Jul-14	SPI24	10	SPI11	Sep-16	SPI21	5	SPI5	Mar-19	SPI13	1	SPI22
Aug-14	SPI23	1	SPI10	Sep-16	SPI22	1	SPI7	Apr-19	SPI12	1	SPI7
Sep-14	SPI4	1	SPI10	Sep-16	SPI25	2	SPI17	Apr-19	SPI14	4	SPI13
Apr-15	SPI13	1	SPI22	Jan-17	SPI4	1	OI1_OPS	Jun-19	SPI14	5	SPI12
May-15	SPI3	1	SPI16	Jan-17	SPI16	1	SPI19	Jul-19	SPI1	2	SPI10
May-15	SPI9	1	SPI17	Feb-17	SPI18	1	SPI1	Jul-19	SPI3	1	SPI1
May-15	SPI23	1	SPI10	Mar-17	SPI1	1	SPI4	Jul-19	SPI24	13	SPI21
Jun-15	SPI16	1	SPI21	Mar-17	SPI25	1	SPI10	Oct-19	SPI3	3	SPI13
Jun-15	SPI20	2	Unknown	May-17	SPI9	1	SPI23	Oct-19	SPI10	2	SPI3
Jul-15	SPI1	1	SPI21	Jun-17	SPI22	1	SPI20	Apr-20	SPI8	1	SPI13
Jul-15	SPI3	1	SPI23	Jun-17	SPI25	1	SPI7	Jun-20	SPI18	1	SPI7
Jul-15	SPI4	1	SPI13	Jul-17	SPI5	3	OI1_OPS	Jul-20	SPI5	3	SPI1
Jul-15	SPI15	10	SPI13	Sep-17	SPI25	1	SPI16	Jul-20	SPI15	11	Unknown
Aug-15	SPI17	1	SPI13	Oct-17	SPI18	1	OI2_PASS	Jul-20	SPI16	1	SPI10
Nov-15	SPI9	1	SPI20	Oct-17	SPI19	1	OI2_PASS	Jul-20	SPI24	6	SPI17
Dec-15	SPI8	1	SPI21	Oct-17	SPI25	1	Unknown	Aug-20	SPI1	1	SPI8
Feb-16	SPI9	1	SPI7	Feb-18	SPI18	2	SPI19	Aug-20	SPI12	1	SPI21
Feb-16	SPI21	3	SPI23	Mar-18	SPI12	1	SPI23	Oct-20	SPI25	1	SPI15
Mar-16	SPI1	1	SPI7	May-18	SPI15	5	SPI13	May-21	SPI14	2	SPI1
Mar-16	SPI7	1	SPI4	Jun-18	SPI25	1	SPI15	Jul-21	SPI2	1	SPI19
May-16	SPI3	1	SPI17	Jul-18	SPI15	6	SPI21	Jul-21	SPI8	2	SPI23
May-16	SPI5	2	SPI1	Jul-18	SPI20	2	SPI23	Jul-21	SPI16	2	SPI21
May-16	SPI7	1	Unknown	Jul-18	SPI21	8	SPI7	Aug-21	SPI24	7	SPI21
May-16	SPI17	1	SPI9	Aug-18	SPI13	1	SPI4				

Source: Author using IBM SPSS Statistics and Microsoft Excel

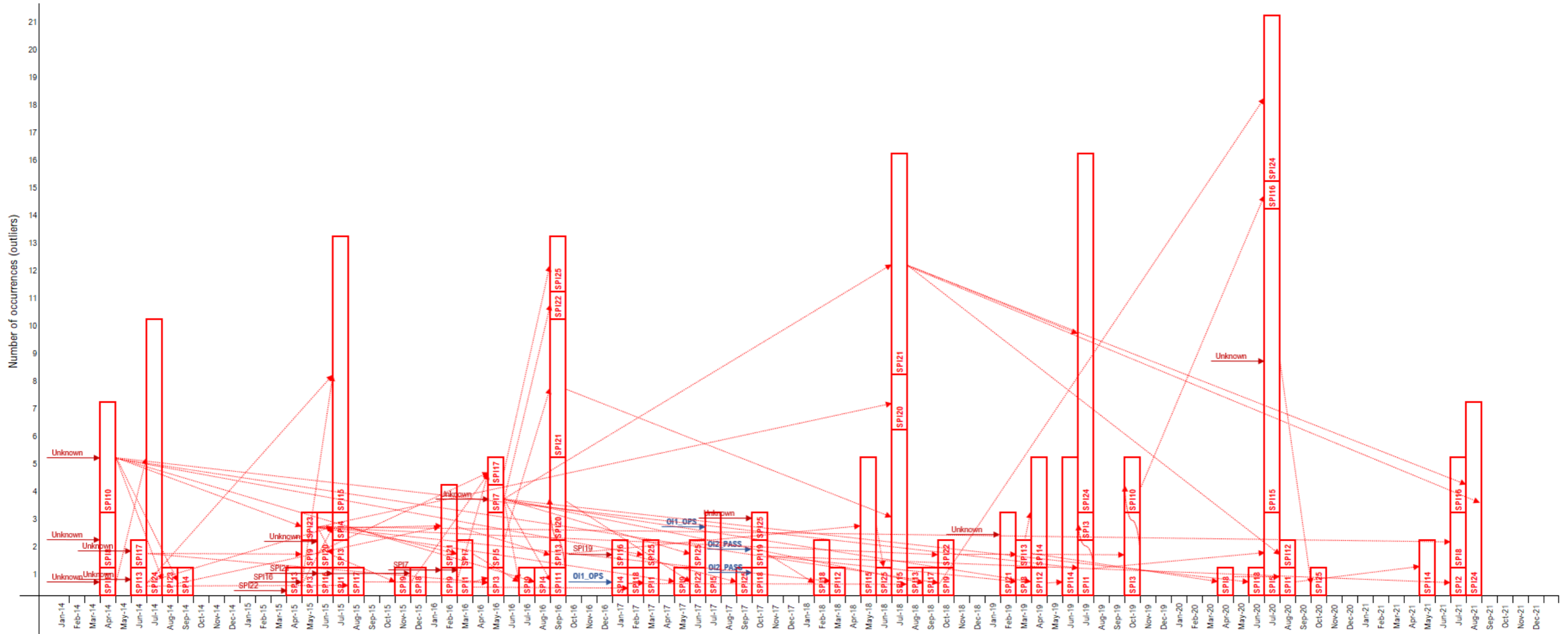


Figure 129 Outliers and root causes over timeline  
 Source: Author using Microsoft Excel

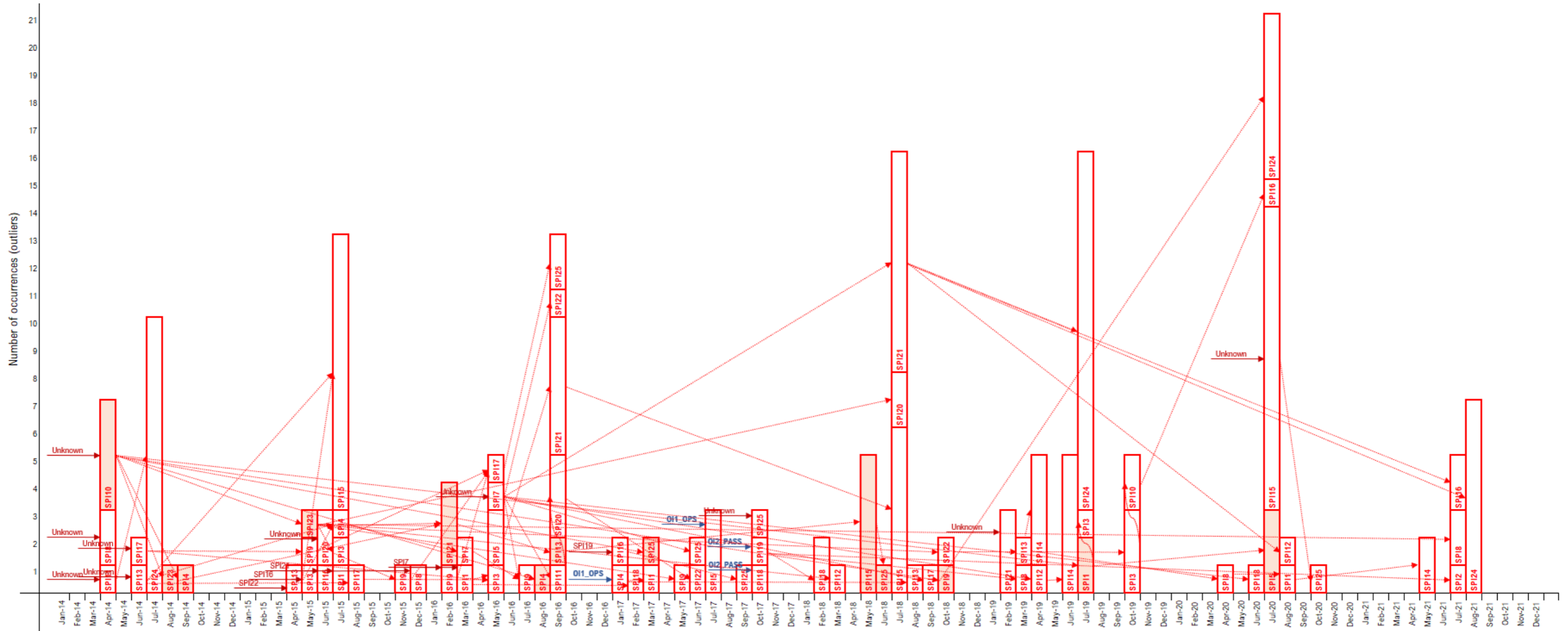


Figure 130 Outliers and root causes over timeline – impact of SPI10  
 Source: Author using Microsoft Excel

## 8.4 Predictive analysis of safety performance: Forecasting of Split Airport organisational and safety performance indicators

In this part of the research, forecasts for each safety performance indicator are made, using the IBM SPSS Statistics software. Forecasting of indicators is conducted using function „Expert Modeler” and „Forecasting using Temporal Causal Model”.

Table 68 shows the obtained forecasted values of organisational indicators in observed data set of Split Airport, i.e., OI1 – Number of aircraft operations and OI2 – Number of passengers using IBM SPSS simple seasonal method of forecasting.

**Table 68 Forecasts of organisational indicators of Split Airport**

Time point	OI1 – Number of operations Model_1	OI2 – Number of passengers Model_2	Graphs
<i>Method</i>	<i>Simple seasonal</i>	<i>Simple seasonal</i>	
Jan 2022	599	20618	
Feb 2022	546	16764	
Mar 2022	658	25049	
Apr 2022	1138	73424	
May 2022	2099	173881	
Jun 2022	3014	287188	
Jul 2022	4605	486821	
Aug 2022	4651	487669	
Sep 2022	2830	319733	
Oct 2022	1891	151833	
Nov 2022	678	25702	
Dec 2022	628	23428	
Jan 2023	599	20618	
Feb 2023	546	16764	
Mar 2023	658	25049	
Apr 2023	1138	73424	
May 2023	2099	173881	
Jun 2023	3014	287188	
Jul 2023	4605	486821	
Aug 2023	4651	487669	
Sep 2023	2830	319733	
Oct 2023	1891	151833	
Nov 2023	678	25702	
Dec 2023	628	23428	

Source: Author using IBM SPSS Statistics

Table 69 shows the obtained forecasted values of organisational indicator in observed data set of Split Airport, i.e., OI1 – Number of aircraft operations. Forecasting using temporal causal

model was performed for 24 safety performance indicators, i.e., for one of SPIs (SPI6) forecast was excluded due to the fact that values are constant, i.e., equal to 0. The forecast period is set up to 10 months, due to the limitation of the software, including October 2022.

**Table 69 Initial forecast of organisational indicator OI1 Number of aircraft operations**

Time point	OI1_OPS	OI1_OPS Graph
Jan 2022	993	
Feb 2022	1687	
Mar 2022	2184	
Apr 2022	2519	
May 2022	2544	
Jun 2022	2399	
Jul 2022	2116	
Aug 2022	1869	
Sep 2022	1715	
Oct 2022	1666	

Source: Author using IBM SPSS Statistics

Table 70 and Figure 131 show first initial forecast of Split Airport safety performance indicators using IBM SPSS function Forecasting using Temporal Causal Model.

Tables 71-74 and Figures 132-133 show second set of initial forecasts of Split Airport safety performance indicators with associated safety performance targets using IBM SPSS function Expert Modeler Forecasting. First set uses ARIMA and smoothing methods, while second set uses smoothing methods only. Set using smoothing methods only could not built a model for safety performance indicator SPI6 because all of values of the series are the same. The forecast period is set up to 24 months.

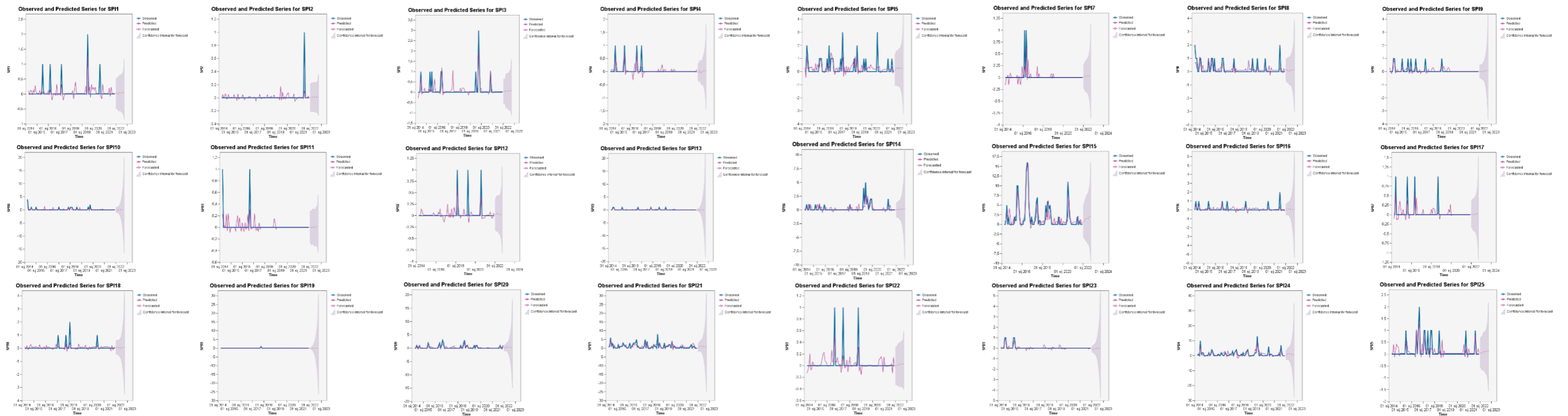
As per Tables and Figures, from predicted values of safety performance indicators, it is evident that higher number of potential occurrences (hazards) is anticipated in nearer future, specifically for SPI15 – Number of occurrences related to passenger handling at the gate, SPI21 – Number of occurrences related to ground traffic (GSE) and vehicle driving, and SPI24 – Number of occurrences related to wildlife. This can be explained with the fact that all of these indicator highlight higher values in the observed time period, especially in summer months, due to larger number of aircraft operations and larger number of passenger, i.e., seasonality component is strongly emphasized at Split Airport. It also explains larger number of wildlife occurrences, because in summer months wildlife activity is also higher.

**Table 70 First initial forecast of Split Airport safety performance indicators (forecasting using temporal causal model)**

Time point	SPI1	SPI2	SPI3	SPI4	SPI5	SPI7	SPI8	SPI9	SPI10	SPI11	SPI12	SPI13	SPI14	SPI15	SPI16	SPI17	SPI18	SPI19	SPI20	SPI21	SPI22	SPI23	SPI24	SPI25
Jan 2022	0.02	0.00	0.03	0.01	0.12	0.00	0.17	0.02	0.06	0.00	0.01	-0.02	0.04	0.63	0.07	0.01	0.05	-0.07	0.40	0.05	-0.01	-0.08	-0.10	0.03
Feb 2022	0.02	0.01	0.04	-0.05	0.18	0.02	0.08	0.01	0.01	0.01	0.03	-0.09	0.05	0.92	0.07	0.02	0.07	-0.05	-0.14	0.80	0.00	-0.08	0.70	0.07
Mar 2022	0.02	0.01	0.04	0.03	0.29	0.02	0.11	-0.01	0.04	-0.01	0.04	-0.01	0.03	1.16	0.12	0.01	0.07	-0.03	0.35	1.06	0.00	-0.06	1.19	0.04
Apr 2022	0.00	0.01	0.06	0.00	0.24	0.03	0.10	0.00	0.00	0.02	0.05	0.04	0.08	1.36	0.13	0.00	0.04	0.02	0.53	1.26	0.01	-0.08	1.31	0.08
May 2022	0.05	0.01	0.07	-0.05	0.31	0.03	0.06	0.02	0.06	0.01	0.04	0.09	-0.01	1.55	0.12	0.01	0.00	0.03	0.30	1.27	0.02	-0.07	1.26	0.13
Jun 2022	0.03	0.01	0.07	0.00	0.28	0.04	0.09	0.05	0.07	-0.01	0.02	0.09	0.13	1.54	0.09	0.01	0.03	0.03	0.29	1.12	0.02	-0.02	0.97	0.09
Jul 2022	0.04	0.01	0.04	0.04	0.28	0.04	0.11	0.07	0.12	0.00	0.02	0.07	0.12	1.62	0.07	0.01	0.03	0.01	0.42	0.96	0.02	0.02	1.04	0.09
Aug 2022	0.03	0.01	0.09	0.04	0.25	0.04	0.13	0.07	0.13	0.02	0.03	0.04	0.21	1.84	0.05	0.02	0.06	0.00	0.36	0.87	0.03	0.01	0.82	0.14
Sep 2022	0.05	0.01	0.08	0.03	0.28	0.04	0.12	0.06	0.12	0.01	0.03	0.04	0.23	2.05	0.05	0.05	0.06	-0.01	0.26	0.80	0.03	-0.01	0.73	0.14
Oct 2022	0.05	0.01	0.09	0.03	0.27	0.04	0.13	0.05	0.11	0.00	0.04	0.03	0.27	2.10	0.06	0.05	0.06	-0.01	0.27	0.83	0.03	-0.01	0.79	0.12

Note: Negative values are perceived as 0.

Source: Author using IBM SPSS Statistics



**Figure 131 Forecasts of Split Airport safety performance indicators (forecasting using temporal causal model)**

Source: Author using IBM SPSS Statistics

Table 71 Second initial forecast of Split Airport safety performance indicators (ARIMA & smoothing methods)

Time point	SPI1	SPI2	SPI3	SPI4	SPI5	SPI6	SPI7	SPI8	SPI9	SPI10	SPI11	SPI12	SPI13	SPI14	SPI15	SPI16	SPI17	SPI18	SPI19	SPI20	SPI21	SPI22	SPI23	SPI24	SPI25
	Simple Seasonal	Simple Seasonal	ARIMA (0,0,2)(1,0,0)	ARIMA (0,1,1)(0,0,0)	ARIMA (0,0,0)(0,1,0)	ARIMA (0,0,0)(0,0,0)	Simple Seasonal	ARIMA (0,0,0)(1,0,0)	Winters' Additive	ARIMA (0,0,0)(0,0,0)	Simple Seasonal	Simple Seasonal	Winters' Additive	Simple Seasonal	ARIMA (1,0,0)(1,0,0)	ARIMA (0,1,1)(0,0,0)	ARIMA (0,1,1)(0,0,0)	ARIMA (0,0,0)(0,0,1)	ARIMA (0,1,0)(0,0,0)	ARIMA (0,0,3)(0,0,0)	ARIMA (0,0,0)(0,0,0)	Simple Seasonal	ARIMA (0,0,0)(0,0,0)	ARIMA (0,0,0)(0,1,1)	ARIMA (0,0,0)(0,0,0)
Jan 2022	0	0	0	0	0	0	0	0	0	0	0	0	0	0	3	-1	0	0	0	0	1	0	0	0	0
Feb 2022	0	0	0	0	0	0	0	0	0	0	0	0	0	0	0	-1	0	0	0	0	1	0	0	0	0
Mar 2022	0	0	0	0	0	0	0	0	0	0	0	0	0	0	0	-1	0	0	0	0	1	0	0	0	0
Apr 2022	0	0	0	0	0	0	0	0	0	0	0	0	0	0	0	-1	0	0	0	0	1	0	0	0	0
May 2022	0	0	0	0	0	0	0	0	0	0	0	0	0	0	0	-1	0	0	0	0	1	0	0	0	0
Jun 2022	0	0	0	0	1	0	0	0	0	0	0	0	0	1	0	-1	0	0	0	0	1	0	0	1	0
Jul 2022	0	0	0	0	0	0	0	0	0	0	0	0	0	0	0	-1	0	0	0	0	1	0	0	0	0
Aug 2022	0	0	0	0	0	0	0	0	0	0	0	0	0	0	0	-1	0	0	0	0	1	0	0	6	0
Sep 2022	0	0	0	0	0	0	0	0	0	0	0	0	0	0	0	-1	0	0	0	0	1	0	0	1	0
Oct 2022	0	0	0	0	1	0	0	0	0	0	0	0	0	0	0	-1	0	0	0	0	1	0	0	0	0
Nov 2022	0	0	0	0	0	0	0	0	0	0	0	0	0	0	0	-1	0	0	0	0	1	0	0	0	0
Dec 2022	0	0	0	0	0	0	0	0	0	0	0	0	0	0	0	0	0	0	0	0	1	0	0	0	0
Jan 2023	0	0	0	0	0	0	0	0	0	0	0	0	0	0	3	-1	0	0	0	0	1	0	0	0	0
Feb 2023	0	0	0	0	0	0	0	0	0	0	0	0	0	0	0	-1	0	0	0	0	1	0	0	0	0
Mar 2023	0	0	0	0	0	0	0	0	0	0	0	0	0	0	0	-1	0	0	0	0	1	0	0	0	0
Apr 2023	0	0	0	0	0	0	0	0	0	0	0	0	0	0	0	-1	0	0	0	0	1	0	0	0	0
May 2023	0	0	0	0	0	0	0	0	0	0	0	0	0	0	0	-1	0	0	0	0	1	0	0	0	0
Jun 2023	0	0	0	0	1	0	0	0	0	0	0	0	0	1	0	-1	0	0	0	0	1	0	0	1	0
Jul 2023	0	0	0	0	0	0	0	0	0	0	0	0	0	0	0	-1	0	0	0	0	1	0	0	0	0
Aug 2023	0	0	0	0	0	0	0	0	0	0	0	0	0	0	0	-1	0	0	0	0	1	0	0	6	0
Sep 2023	0	0	0	0	0	0	0	0	0	0	0	0	0	0	0	-1	0	0	0	0	1	0	0	1	0
Oct 2023	0	0	0	0	1	0	0	0	0	0	0	0	0	0	0	-1	0	0	0	0	1	0	0	0	0
Nov 2023	0	0	0	0	0	0	0	0	0	0	0	0	0	0	0	-1	0	0	0	0	1	0	0	0	0
Dec 2023	0	0	0	0	0	0	0	0	0	0	0	0	0	0	0	0	0	0	0	0	1	0	0	0	0

Note: Negative values are perceived as 0.  
Source: Author using IBM SPSS Statistics

Table 72 Associated forecast of Split Airport safety performance targets (ARIMA & smoothing methods)

Time point	SPT1	SPT2	SPT3	SPT4	SPT5	SPT6	SPT7	SPT8	SPT9	SPT10	SPT11	SPT12	SPT13	SPT14	SPT15	SPT16	SPT17	SPT18	SPT19	SPT20	SPT21	SPT22	SPT23	SPT24	SPT25
	ARIMA (0,0,0)(0,0,0)	Simple Seasonal	ARIMA (0,0,0)(0,0,1)	ARIMA (0,0,1)(1,0,2)	ARIMA (0,0,0)(0,0,0)	ARIMA (0,0,0)(0,0,0)	ARIMA (0,0,0)(0,0,0)	Simple Seasonal	Simple Seasonal	ARIMA (0,0,0)(1,0,0)	ARIMA (0,1,1)(0,0,0)	Simple Seasonal	Simple Seasonal	ARIMA (0,0,3)(0,0,0)	ARIMA (1,0,0)(0,0,0)	Simple Seasonal	Simple Seasonal	ARIMA (0,0,0)(0,0,0)	Simple Seasonal	ARIMA (0,0,0)(0,0,0)	ARIMA (0,0,0)(0,0,0)	Simple Seasonal	Simple Seasonal	ARIMA (0,0,0)(0,0,0)	ARIMA (0,0,0)(0,0,0)
Jan 2022	0.0000	0.0000	0.0000	0.0000	0.0002	0.0000	0.0000	-0.0006	-0.0001	0.0000	0.0000	0.0000	0.0000	0.0000	0.0000	0.0002	0.0000	0.0000	0.0000	0.0003	0.0005	0.0000	0.0000	0.0004	0.0000
Feb 2022	0.0000	0.0000	0.0000	0.0000	0.0000	0.0000	0.0000	-0.0006	0.0002	0.0000	0.0000	0.0000	0.0000	0.0000	0.0000	0.0000	0.0003	0.0000	0.0000	0.0000	0.0005	0.0000	0.0000	0.0004	0.0000
Mar 2022	0.0000	0.0000	0.0000	0.0000	0.0000	0.0000	0.0000	-0.0005	-0.0001	0.0000	0.0000	0.0001	0.0001	0.0000	0.0000	0.0000	0.0000	0.0000	0.0000	0.0000	0.0005	0.0000	0.0000	0.0004	0.0000
Apr 2022	0.0000	0.0000	0.0000	0.0000	0.0000	0.0000	0.0000	0.0074	-0.0001	0.0000	0.0000	0.0001	0.0001	0.0000	0.0000	0.0000	0.0000	0.0000	0.0000	0.0000	0.0005	0.0000	0.0000	0.0004	0.0000
May 2022	0.0000	0.0000	0.0000	0.0000	0.0000	0.0000	0.0000	-0.0005	0.0000	0.0000	0.0000	0.0000	0.0000	0.0000	0.0000	0.0000	0.0000	0.0000	0.0000	0.0000	0.0005	0.0000	0.0000	0.0004	0.0000
Jun 2022	0.0000	0.0000	0.0000	0.0000	0.0000	0.0000	0.0000	-0.0005	-0.0001	0.0000	0.0000	0.0000	0.0000	0.0000	0.0000	0.0000	0.0000	0.0000	0.0000	0.0000	0.0005	0.0000	0.0000	0.0004	0.0000
Jul 2022	0.0000	0.0000	0.0000	0.0000	0.0000	0.0000	0.0000	-0.0006	0.0000	0.0000	0.0000	0.0000	0.0000	0.0000	0.0000	0.0001	0.0000	0.0000	0.0000	0.0000	0.0005	0.0000	0.0000	0.0004	0.0000
Aug 2022	0.0000	0.0000	0.0000	0.0000	0.0000	0.0000	0.0000	-0.0005	0.0000	0.0000	0.0000	0.0000	0.0000	0.0000	0.0000	0.0001	0.0000	0.0000	0.0000	0.0000	0.0005	0.0000	0.0000	0.0004	0.0000
Sep 2022	0.0000	0.0000	0.0000	0.0000	0.0000	0.0000	0.0000	-0.0005	0.0000	0.0000	0.0000	0.0000	0.0000	0.0000	0.0000	0.0000	0.0000	0.0000	0.0000	0.0000	0.0005	0.0000	0.0000	0.0004	0.0000
Oct 2022	0.0000	0.0000	0.0000	0.0000	0.0000	0.0000	0.0000	-0.0004	0.0000	0.0000	0.0000	0.0000	0.0000	0.0000	0.0000	0.0000	0.0000	0.0000	0.0001	0.0000	0.0005	0.0000	0.0000	0.0004	0.0000
Nov 2022	0.0000	0.0000	0.0000	0.0000	0.0000	0.0000	0.0000	-0.0006	0.0001	0.0000	0.0000	0.0000	0.0002	0.0000	0.0000	0.0000	0.0000	0.0000	0.0000	0.0000	0.0005	0.0000	0.0000	0.0004	0.0000

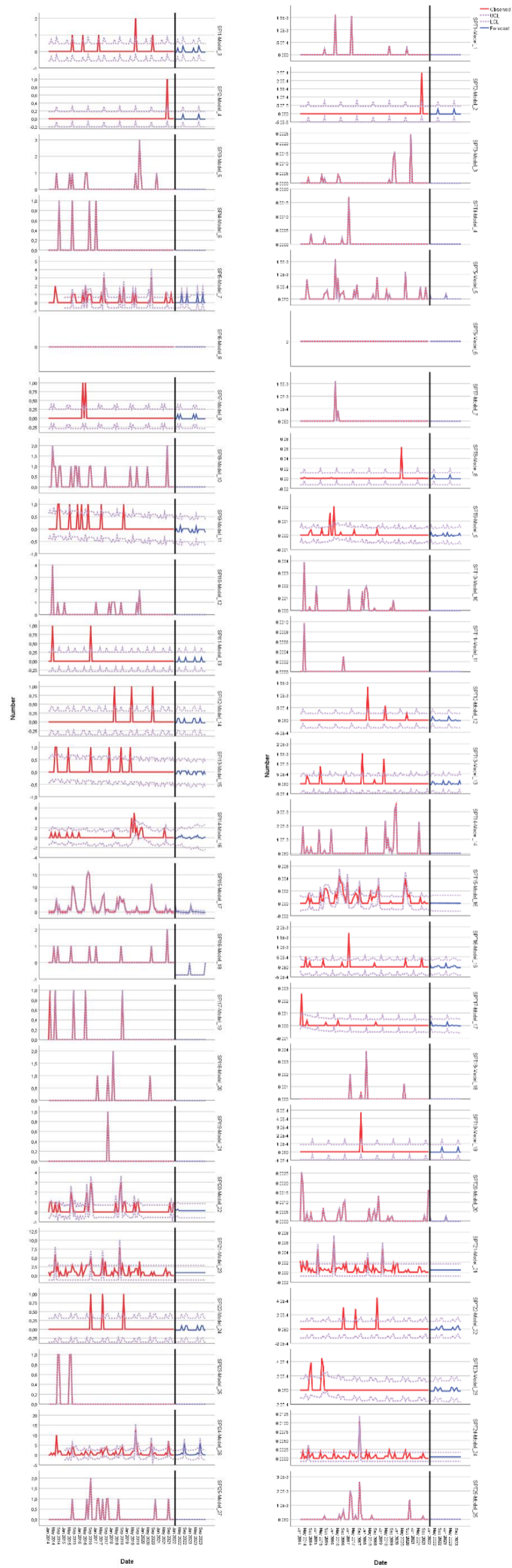




**Table 74 Associated forecast of Split Airport safety performance targets (smoothing methods only)**

Time point	SPT1	SPT2	SPT3	SPT4	SPT5	SPT7	SPT8	SPT9	SPT10	SPT11	SPT12	SPT13	SPT14	SPT15	SPT16	SPT17	SPT18	SPT19	SPT20	SPT21	SPT22	SPT23	SPT24	SPT25
	Simple Seasonal	Simple Seasonal	Simple Seasonal	Simple Seasonal	Winters' Additive	Simple Seasonal	Simple Seasonal	Simple Seasonal	Winters' Additive	Simple Seasonal	Simple Seasonal	Simple Seasonal	Simple Seasonal	Simple Seasonal	Simple Seasonal	Simple Seasonal	Simple Seasonal	Simple Seasonal	Simple Seasonal	Simple Seasonal	Winters' Additive	Simple Seasonal	Simple Seasonal	Simple Seasonal
Jan 2022	0.0000	0.0000	0.0000	0.0002	0.0000	0.0000	-0.0006	-0.0001	0.0005	0.0000	0.0000	0.0000	-0.0001	-0.0006	0.0002	0.0000	-0.0001	0.0000	0.0003	0.0005	0.0000	0.0000	-0.0003	-0.0001
Feb 2022	0.0000	0.0000	0.0000	0.0000	0.0000	0.0000	-0.0006	0.0002	0.0001	0.0000	0.0000	0.0000	0.0002	-0.0006	0.0000	0.0003	0.0007	0.0000	0.0007	0.0015	0.0000	0.0000	0.0005	0.0002
Mar 2022	0.0004	0.0000	0.0000	0.0000	0.0002	0.0002	-0.0005	-0.0001	0.0000	0.0000	0.0001	0.0001	0.0004	-0.0004	0.0000	0.0000	-0.0001	0.0000	0.0006	0.0002	0.0000	0.0000	0.0002	0.0001
Apr 2022	0.0000	0.0000	0.0000	0.0000	0.0000	0.0000	0.0074	-0.0001	0.0003	0.0001	0.0001	0.0001	0.0002	-0.0001	0.0000	0.0000	-0.0001	0.0000	0.0004	0.0001	0.0000	0.0000	0.0003	-0.0001
May 2022	0.0000	0.0000	0.0001	0.0000	0.0001	0.0000	-0.0005	0.0000	-0.0002	0.0000	0.0000	0.0000	0.0003	0.0001	0.0000	0.0000	-0.0001	0.0000	0.0004	0.0001	0.0000	0.0000	0.0001	-0.0001
Jun 2022	0.0000	0.0000	0.0000	0.0000	0.0001	0.0000	-0.0005	-0.0001	-0.0002	0.0000	0.0000	0.0000	0.0001	0.0007	0.0000	0.0000	0.0001	0.0000	0.0006	0.0004	0.0000	0.0000	0.0001	0.0000
Jul 2022	0.0000	0.0000	0.0001	0.0000	0.0003	0.0000	-0.0006	0.0000	-0.0002	0.0000	0.0000	0.0000	0.0000	0.0010	0.0001	0.0000	-0.0001	0.0000	0.0004	0.0000	0.0000	0.0000	0.0008	0.0000
Aug 2022	0.0000	0.0000	0.0000	0.0000	0.0000	0.0000	-0.0005	0.0000	-0.0001	0.0000	0.0000	0.0000	0.0000	0.0005	0.0001	0.0000	-0.0001	0.0000	0.0005	0.0000	0.0000	0.0000	0.0003	0.0000
Sep 2022	0.0000	0.0000	0.0000	0.0000	0.0000	0.0000	-0.0005	0.0000	-0.0002	0.0000	0.0000	0.0000	0.0000	0.0006	0.0000	0.0000	-0.0001	0.0000	0.0006	0.0000	0.0000	0.0000	0.0015	0.0003
Oct 2022	0.0000	0.0000	0.0001	0.0000	0.0001	0.0000	-0.0004	0.0000	-0.0001	0.0000	0.0000	0.0000	0.0000	0.0002	0.0000	0.0000	0.0000	0.0001	0.0005	0.0001	0.0000	0.0000	0.0002	0.0002
Nov 2022	0.0000	0.0000	0.0005	0.0000	0.0000	0.0000	-0.0006	0.0001	0.0000	0.0000	0.0000	0.0002	0.0003	-0.0003	0.0000	0.0000	-0.0001	0.0000	0.0005	-0.0002	0.0000	0.0000	-0.0001	-0.0001
Dec 2022	0.0000	0.0000	0.0000	0.0000	0.0000	0.0000	-0.0004	-0.0001	-0.0002	0.0000	0.0000	0.0000	0.0006	-0.0002	0.0000	0.0000	-0.0001	0.0000	0.0005	-0.0002	0.0000	0.0000	-0.0003	-0.0001
Jan 2023	0.0000	0.0000	0.0000	0.0002	-0.0001	0.0000	-0.0006	-0.0001	0.0005	0.0000	0.0000	0.0000	-0.0001	-0.0006	0.0002	0.0000	-0.0001	0.0000	0.0003	0.0005	0.0000	0.0000	-0.0003	-0.0001
Feb 2023	0.0000	0.0000	0.0000	0.0000	-0.0001	0.0000	-0.0006	0.0002	0.0000	0.0000	0.0000	0.0000	0.0002	-0.0006	0.0000	0.0003	0.0007	0.0000	0.0007	0.0014	0.0000	0.0000	0.0005	0.0002
Mar 2023	0.0004	0.0000	0.0000	0.0000	0.0001	0.0002	-0.0005	-0.0001	0.0000	0.0000	0.0001	0.0001	0.0004	-0.0004	0.0000	0.0000	-0.0001	0.0000	0.0006	0.0001	0.0000	0.0000	0.0002	0.0001
Apr 2023	0.0000	0.0000	0.0000	0.0000	-0.0001	0.0000	0.0074	-0.0001	0.0003	0.0001	0.0001	0.0001	0.0002	-0.0001	0.0000	0.0000	-0.0001	0.0000	0.0004	0.0000	0.0000	0.0000	0.0003	-0.0001
May 2023	0.0000	0.0000	0.0001	0.0000	0.0001	0.0000	-0.0005	0.0000	-0.0002	0.0000	0.0000	0.0000	0.0003	0.0001	0.0000	0.0000	-0.0001	0.0000	0.0004	0.0000	0.0000	0.0000	0.0001	-0.0001
Jun 2023	0.0000	0.0000	0.0000	0.0000	0.0001	0.0000	-0.0005	-0.0001	-0.0002	0.0000	0.0000	0.0000	0.0001	0.0007	0.0000	0.0000	0.0001	0.0000	0.0006	0.0003	0.0000	0.0000	0.0001	0.0000
Jul 2023	0.0000	0.0000	0.0001	0.0000	0.0003	0.0000	-0.0006	0.0000	-0.0002	0.0000	0.0000	0.0000	0.0000	0.0010	0.0001	0.0000	-0.0001	0.0000	0.0004	0.0000	0.0000	0.0000	0.0008	0.0000
Aug 2023	0.0000	0.0000	0.0000	0.0000	0.0000	0.0000	-0.0005	0.0000	-0.0001	0.0000	0.0000	0.0000	0.0000	0.0005	0.0001	0.0000	-0.0001	0.0000	0.0005	-0.0001	0.0000	0.0000	0.0003	0.0000
Sep 2023	0.0000	0.0000	0.0000	0.0000	0.0000	0.0000	-0.0005	0.0000	-0.0002	0.0000	0.0000	0.0000	0.0000	0.0006	0.0000	0.0000	-0.0001	0.0000	0.0006	-0.0001	0.0000	0.0000	0.0015	0.0003
Oct 2023	0.0000	0.0000	0.0001	0.0000	0.0001	0.0000	-0.0004	0.0000	-0.0001	0.0000	0.0000	0.0000	0.0000	0.0002	0.0000	0.0000	0.0000	0.0001	0.0005	0.0000	0.0000	0.0000	0.0002	0.0002
Nov 2023	0.0000	0.0000	0.0005	0.0000	-0.0001	0.0000	-0.0006	0.0001	0.0000	0.0000	0.0000	0.0002	0.0003	-0.0003	0.0000	0.0000	-0.0001	0.0000	0.0005	-0.0003	0.0000	0.0000	-0.0001	-0.0001
Dec 2023	0.0000	0.0000	0.0000	0.0000	-0.0001	0.0000	-0.0004	-0.0001	-0.0002	0.0000	0.0000	0.0000	0.0006	-0.0002	0.0000	0.0000	-0.0001	0.0000	0.0005	-0.0003	0.0000	0.0000	-0.0003	-0.0001

Note: Negative values are perceived as 0.  
Source: Author using IBM SPSS Statistics



**Figure 132 Forecasts of Split Airport safety performance indicators and targets (ARIMA & smoothing methods)**  
 Source: Author using IBM SPSS Statistics

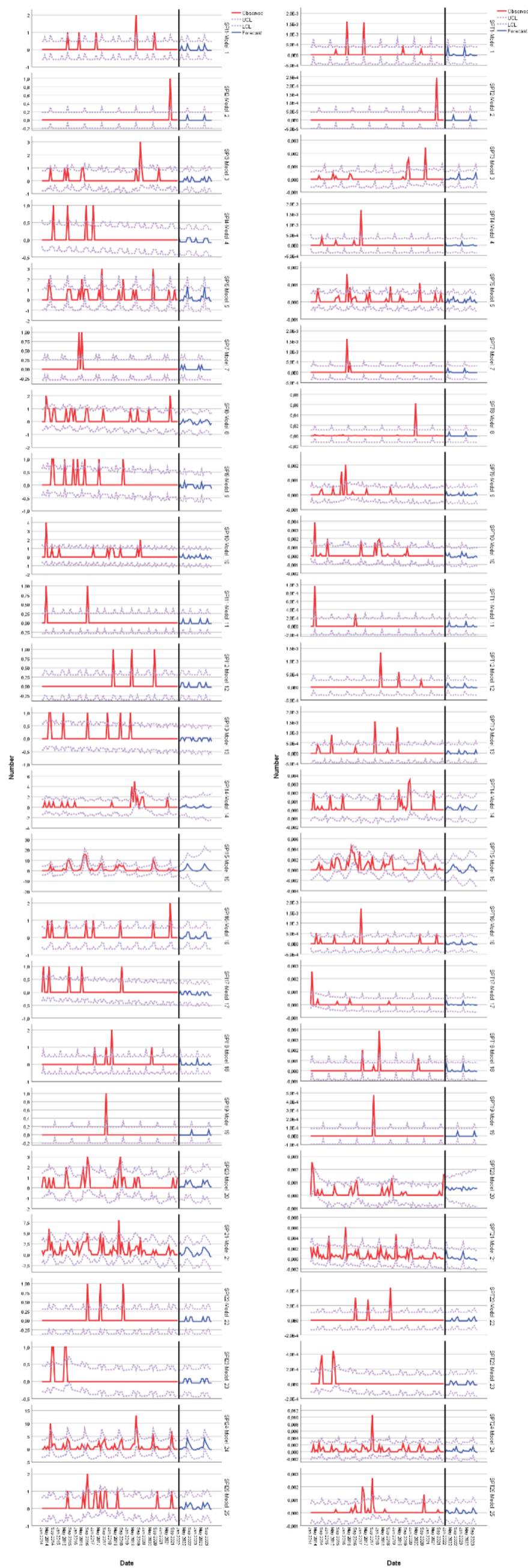


Figure 133 Forecasts of Split Airport safety performance indicators and targets (smoothing methods only)  
 Source: Author using IBM SPSS Statistics

## 8.5 Predictive analysis of safety performance indicators and causal modelling: Scenario cases for Split Airport

Using causal model presented in 8.2, specifically their relations, it can be learned which indicators (variables) should be modified in order to obtain desired levels in each safety performance indicator.

This part shows how values of organisational indicators (in this case two available organisational indicators OI1 – Number of aircraft operations and OI2 – Number of passengers) effect future behaviour of safety performance indicators, i.e., how they can influence or trigger adverse events in airport operations.

Four scenario cases are built to show how different values of organisational indicators (lower or higher than original values), due to established causal relations, impact future occurrences at Split Airport.

### 8.5.1 Scenario 1 – Impact on safety performance indicators due to increase of aircraft operations

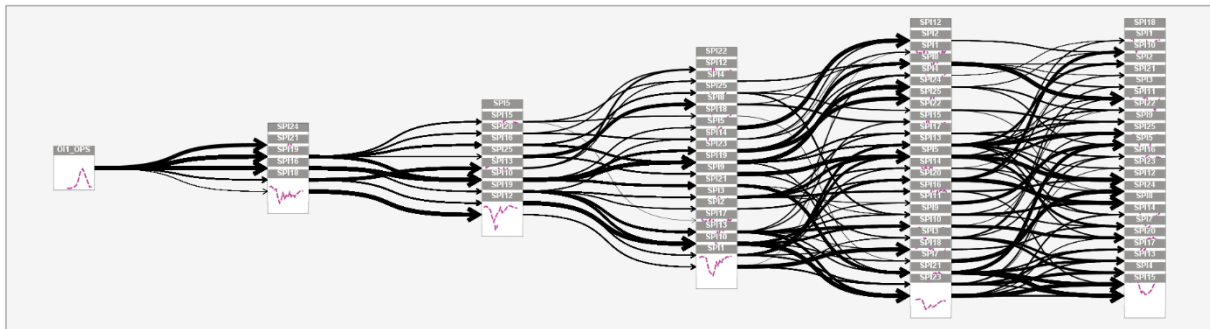
First scenario shows increase of organisational indicator OI1 – Number of aircraft operations and its impact on safety performance indicators. Table 75 shows original values of OI1 and increased values of OI1 for 30%, as well the graph.

**Table 75 Increase of organisational indicator OI1 Number of aircraft operations**

Time point	OI1_OPS initial	OI1_OPS increased for 30%	Graph
Jan 2021	314	408	
Feb 2021	274	356	
Mar 2021	358	465	
Apr 2021	587	763	
May 2021	883	1148	
Jun 2021	2051	2666	
Jul 2021	4084	5309	
Aug 2021	4728	6146	
Sep 2021	3435	4466	
Oct 2021	2090	2717	
Nov 2021	613	797	
Dec 2021	615	800	

Source: Author using IBM SPSS Statistics

Figure 134 shows impact diagram of increased organisational indicator OI1 on all safety performance indicators.

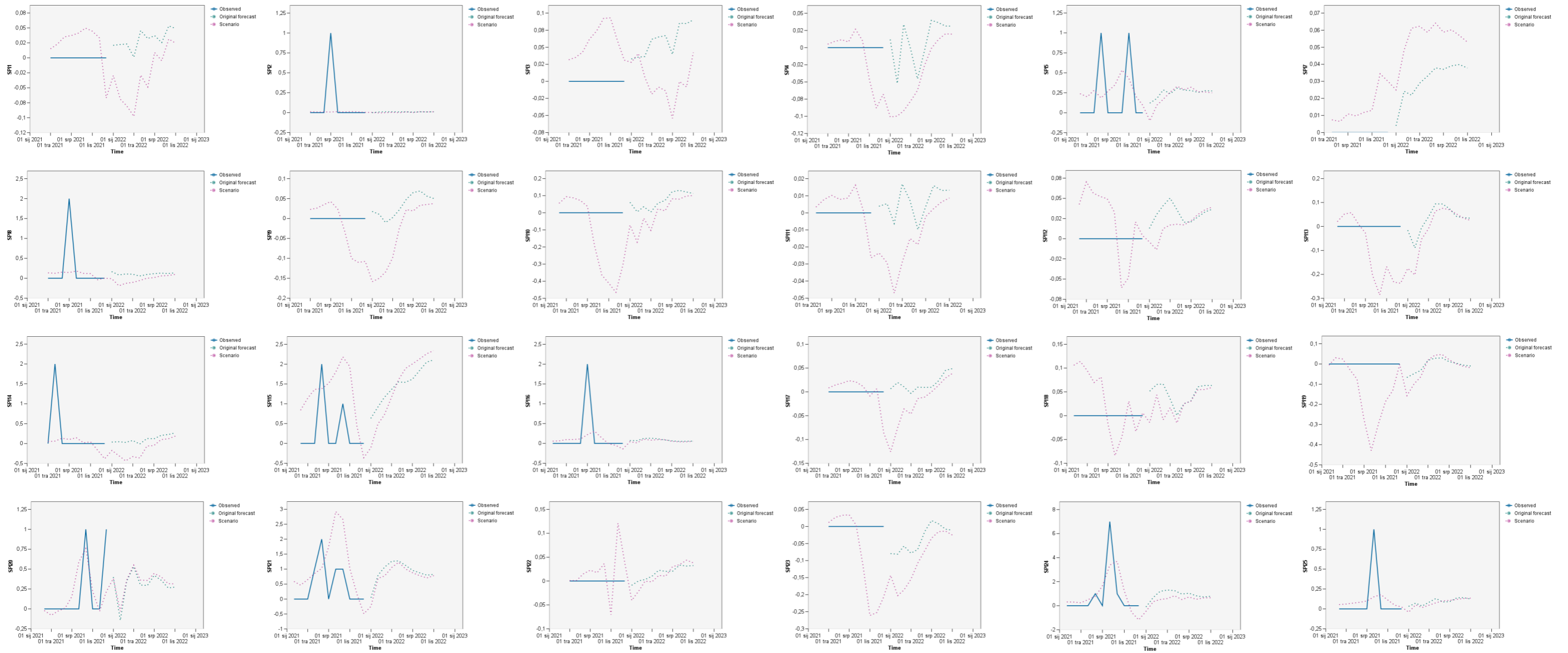


**Figure 134 Impact diagram of increased organisational indicator OI1 on safety performance indicators**

*Source: Author using IBM SPSS Statistics*

Figure 135 shows that, due to increase of 30% in organisational indicator OI1 – Number of aircraft operations, scenario safety performance indicator SPI1 – Number of occurrences related to LIRF and loadsheet crosscheck will decrease (pink graph), in comparison to the original forecasted values (green graph). Scenario SPI2 – Number of occurrences related to wrong figures for loadsheet will remain the same (pink graph), in comparison to the original forecasted values (green graph). Scenario SPI3 – Number of dangerous goods incidents will decrease (pink graph), in comparison to the original forecasted values (green graph). Scenario SPI4 – Number of aircraft damage occurrences will decrease (pink graph), in comparison to the original forecasted values (green graph). Scenario SPI5 – Number of personnel or passenger injuries will remain the same (pink graph), in comparison to the original forecasted values (green graph). Scenario SPI7 – Number of training deficiencies will increase (pink graph), in comparison to the original forecasted values (green graph). Scenario SPI8 – Number of apron maintenance incidents will decrease (pink graph), in comparison to the original forecasted values (green graph). Scenario SPI9 – Number of vehicle maintenance incidents will decrease (pink graph), in comparison to the original forecasted values (green graph). Scenario SPI10 – Number of occurrences related to manoeuvring area maintenance will decrease (pink graph), in comparison to the original forecasted values (green graph). Scenario SPI11 – Number of occurrences related to communication will decrease (pink graph), in comparison to the original forecasted values (green graph). Scenario SPI12 – Number of incidents related to taxiing to/from apron will decrease (pink graph), in comparison to the original forecasted values (green graph). Scenario SPI13 – Number of aircraft marshalling occurrences will decrease (pink graph), in comparison to the original forecasted values (green graph). Scenario SPI14 – Number of occurrences related to FOD presence will decrease (pink graph), in comparison to the original forecasted values (green graph). Scenario SPI15 – Number of occurrences related to passenger handling at the gate will slightly increase (pink graph), in comparison to the original forecasted values (green graph). Scenario SPI16 – Number of occurrences related to passenger handling – disembarking/embarking will remain the same (pink graph), in comparison to the original forecasted values (green graph). Scenario SPI17 – Number of occurrences related to personal protective equipment will decrease (pink graph), in comparison to the original forecasted values (green graph). Scenario SPI18 – Number of aircraft chocking incidents will decrease (pink graph), in comparison to the original forecasted values (green graph). Scenario SPI19 – Number of aircraft conning incidents will remain the same (pink graph), in comparison to the original

forecasted values (green graph). Scenario SPI20 – Number of occurrences related to baggage loading/unloading will remain the same (pink graph), in comparison to the original forecasted values (green graph). Scenario SPI21 – Number of occurrences related to ground traffic (GSE) and vehicle driving will remain the same (pink graph), in comparison to the original forecasted values (green graph). Scenario SPI22 – Number of anti-collision occurrences will remain the same (pink graph), in comparison to the original forecasted values (green graph). Scenario SPI23 – Number of engine start-up incidents will decrease (pink graph), in comparison to the original forecasted values (green graph). Scenario SPI24 – Number of occurrences related to wildlife will slightly decrease (pink graph), in comparison to the original forecasted values (green graph). Scenario SPI25 – Number of occurrences related to fuel handling will remain the same (pink graph), in comparison to the original forecasted values (green graph).

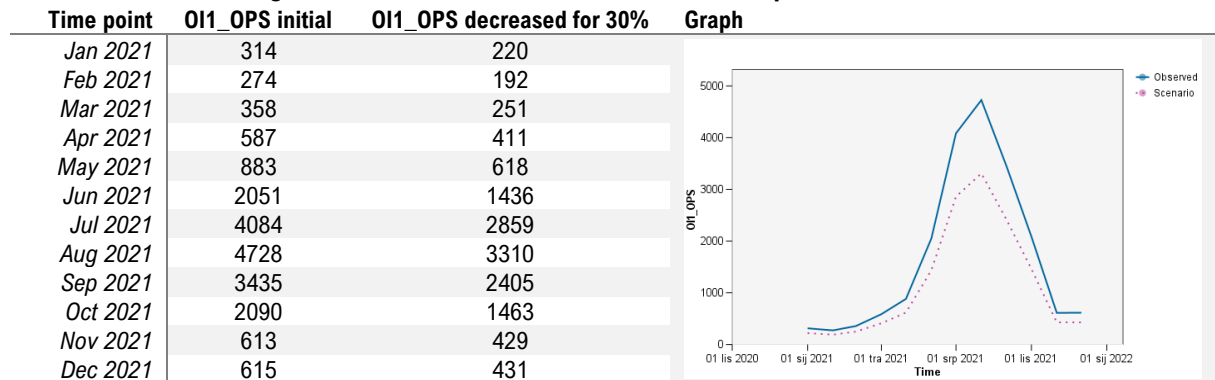


**Figure 135 Predicted safety performance indicators due to increased organisational indicator O11**  
*Source: Author using IBM SPSS Statistics*

## 8.5.2 Scenario 2 – Impact on safety performance indicators due to decrease of aircraft operations

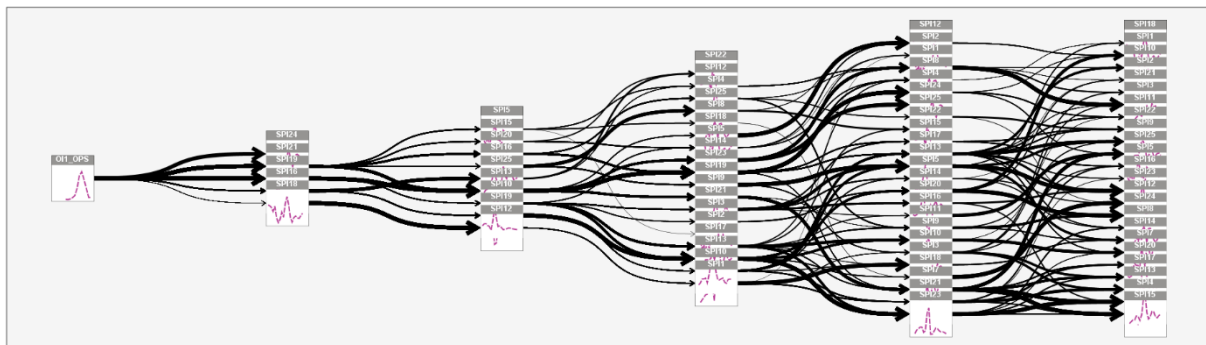
Second scenario shows decrease of organisational indicator OI1 – Number of aircraft operations and its impact on safety performance indicators. Table 76 shows original values of OI1 and decreased values of OI1 for 30%, as well the graph.

**Table 76 Decrease of organisational indicator OI1 Number of aircraft operations**



Source: Author using IBM SPSS Statistics

Figure 136 shows impact diagram of decreased organisational indicator OI1 on all safety performance indicators.



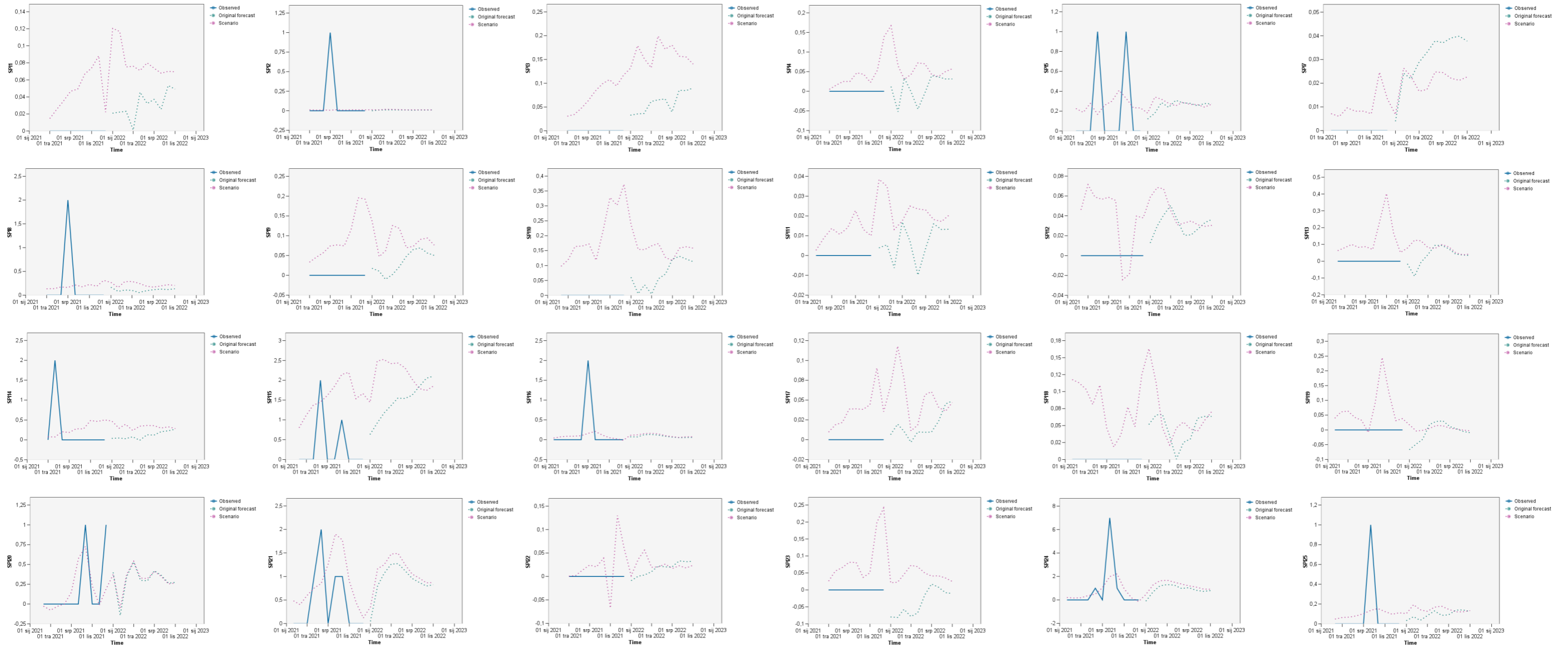
**Figure 136 Impact diagram of decreased organisational indicator OI1 on safety performance indicators**

Source: Author using IBM SPSS Statistics

Figure 137 shows that, due to decrease of 30% in organisational indicator OI1 – Number of aircraft operations, scenario safety performance indicator SPI1 – Number of occurrences related to LIRF and loadsheet crosscheck will increase (pink graph), in comparison to the original forecasted values (green graph). Scenario SPI2 – Number of occurrences related to wrong figures for loadsheet will remain the same (pink graph), in comparison to the original forecasted values (green graph). Scenario SPI3 – Number of dangerous goods incidents will increase (pink



graph), in comparison to the original forecasted values (green graph). Scenario SPI4 – Number of aircraft damage occurrences will increase (pink graph), in comparison to the original forecasted values (green graph). Scenario SPI5 – Number of personnel or passenger injuries will remain the same (pink graph), in comparison to the original forecasted values (green graph). Scenario SPI7 – Number of training deficiencies will decrease (pink graph), in comparison to the original forecasted values (green graph). Scenario SPI8 – Number of apron maintenance incidents will increase (pink graph), in comparison to the original forecasted values (green graph). Scenario SPI9 – Number of vehicle maintenance incidents will increase (pink graph), in comparison to the original forecasted values (green graph). Scenario SPI10 – Number of occurrences related to manoeuvring area maintenance will increase (pink graph), in comparison to the original forecasted values (green graph). Scenario SPI11 – Number of occurrences related to communication will increase (pink graph), in comparison to the original forecasted values (green graph). Scenario SPI12 – Number of incidents related to taxiing to/from apron will increase (pink graph), in comparison to the original forecasted values (green graph). Scenario SPI13 – Number of aircraft marshalling occurrences will increase (pink graph), in comparison to the original forecasted values (green graph). Scenario SPI14 – Number of occurrences related to FOD presence will increase (pink graph), in comparison to the original forecasted values (green graph). Scenario SPI15 – Number of occurrences related to passenger handling at the gate will increase (pink graph), in comparison to the original forecasted values (green graph). Scenario SPI16 – Number of occurrences related to passenger handling – disembarking/embarking will remain the same (pink graph), in comparison to the original forecasted values (green graph). Scenario SPI17 – Number of occurrences related to personal protective equipment will increase (pink graph), in comparison to the original forecasted values (green graph). Scenario SPI18 – Number of aircraft chocking incidents will increase (pink graph), in comparison to the original forecasted values (green graph). Scenario SPI19 – Number of aircraft conning incidents will remain the same (pink graph), in comparison to the original forecasted values (green graph). Scenario SPI20 – Number of occurrences related to baggage loading/unloading will remain the same (pink graph), in comparison to the original forecasted values (green graph). Scenario SPI21 – Number of occurrences related to ground traffic (GSE) and vehicle driving will increase (pink graph), in comparison to the original forecasted values (green graph). Scenario SPI22 – Number of anti-collision occurrences will increase (pink graph), in comparison to the original forecasted values (green graph). Scenario SPI23 – Number of engine start-up incidents will increase (pink graph), in comparison to the original forecasted values (green graph). Scenario SPI24 – Number of occurrences related to wildlife will slightly increase (pink graph), in comparison to the original forecasted values (green graph). Scenario SPI25 – Number of occurrences related to fuel handling will slightly increase (pink graph), in comparison to the original forecasted values (green graph).

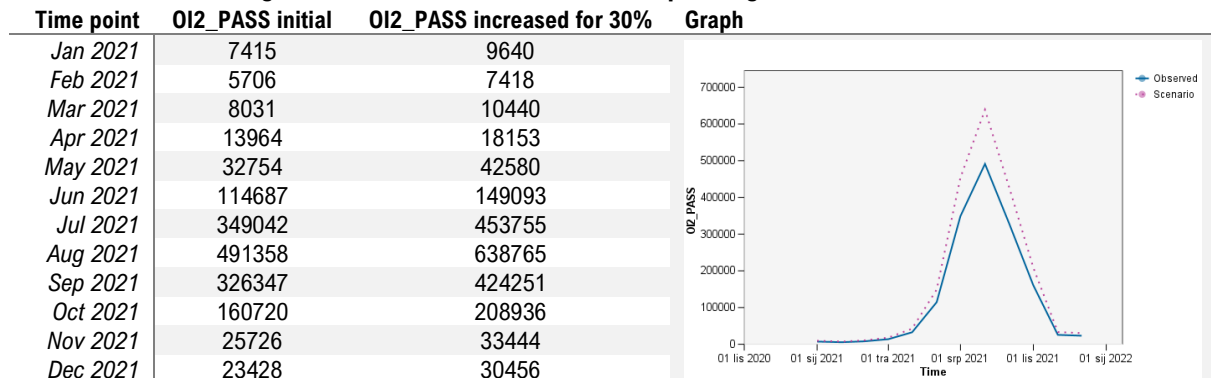


**Figure 137 Predicted safety performance indicators due to decreased organisational indicator O11**  
*Source: Author using IBM SPSS Statistics*

### 8.5.3 Scenario 3 – Impact on safety performance indicators due to increase of number of passengers

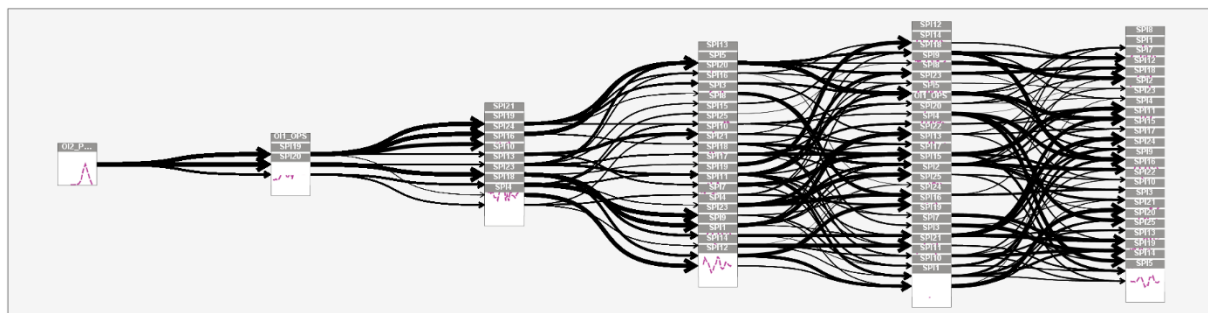
Third scenario shows increase of organisational indicator OI2 – Number of passengers and its impact on safety performance indicators. Table 77 shows original values of OI2 and increased values of OI2 for 30%, as well the graph.

**Table 77 Increase of organisational indicator OI2 Number of passengers**



Source: Author using IBM SPSS Statistics

Figure 138 shows impact diagram of increased organisational indicator OI2 on all safety performance indicators.

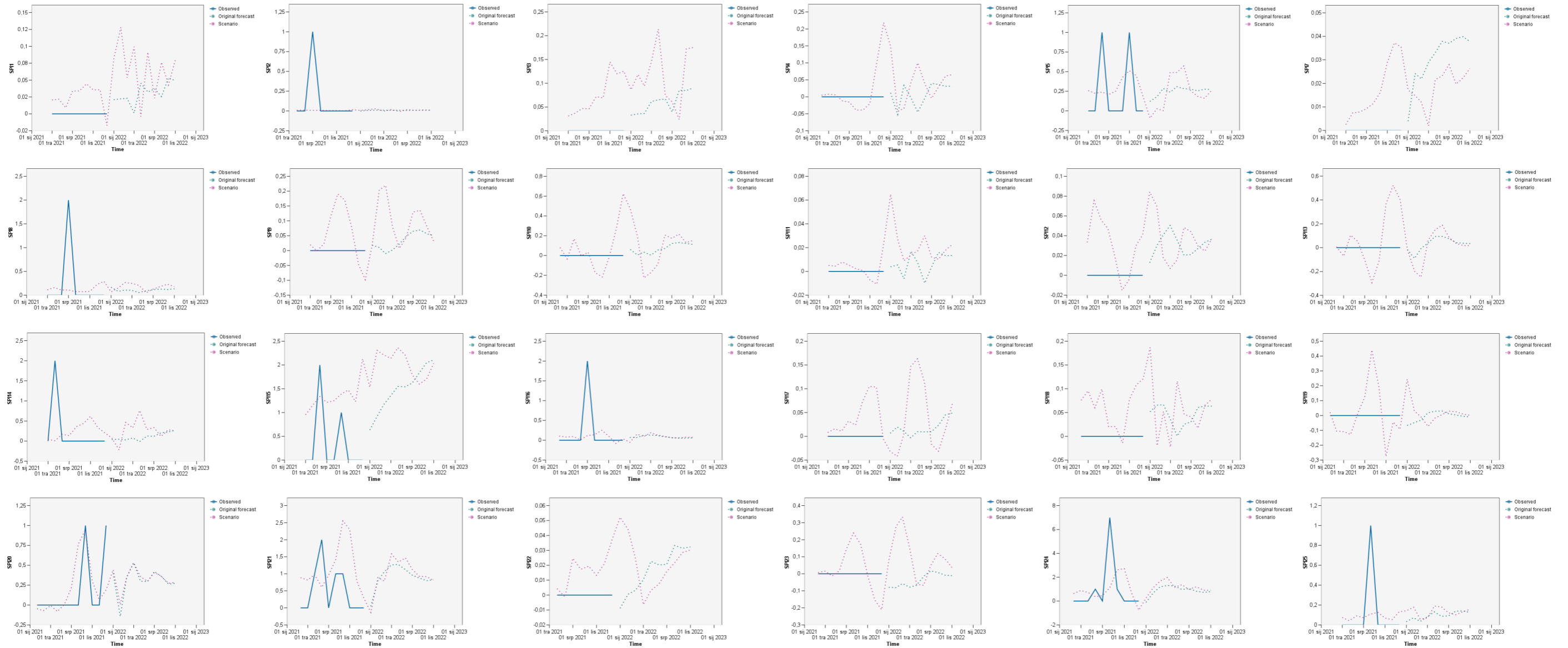


**Figure 138 Impact diagram of increased organisational indicator OI2 on safety performance indicators**

Source: Author using IBM SPSS Statistics

Figure 139 shows that, due to increase of 30% in organisational indicator OI2 – Number of passengers, scenario safety performance indicator SPI1 – Number of occurrences related to LIRF and loadsheet crosscheck will increase (pink graph), in comparison to the original forecasted values (green graph). Scenario SPI2 – Number of occurrences related to wrong figures for loadsheet will remain the same (pink graph), in comparison to the original forecasted values (green graph). Scenario SPI3 – Number of dangerous goods incidents will increase (pink graph), in comparison to the original forecasted values (green graph). Scenario SPI4 – Number

of aircraft damage occurrences will increase (pink graph), in comparison to the original forecasted values (green graph). Scenario SPI5 – Number of personnel or passenger injuries will increase (pink graph), in comparison to the original forecasted values (green graph). Scenario SPI7 – Number of training deficiencies will decrease (pink graph), in comparison to the original forecasted values (green graph). Scenario SPI8 – Number of apron maintenance incidents will remain the same (pink graph), in comparison to the original forecasted values (green graph). Scenario SPI9 – Number of vehicle maintenance incidents will increase (pink graph), in comparison to the original forecasted values (green graph). Scenario SPI10 – Number of occurrences related to manoeuvring area maintenance will increase (pink graph), in comparison to the original forecasted values (green graph). Scenario SPI11 – Number of occurrences related to communication will increase (pink graph), in comparison to the original forecasted values (green graph). Scenario SPI12 – Number of incidents related to taxiing to/from apron will increase (pink graph), in comparison to the original forecasted values (green graph). Scenario SPI13 – Number of aircraft marshalling occurrences will remain the same (pink graph), in comparison to the original forecasted values (green graph). Scenario SPI14 – Number of occurrences related to FOD presence will increase (pink graph), in comparison to the original forecasted values (green graph). Scenario SPI15 – Number of occurrences related to passenger handling at the gate will increase (pink graph), in comparison to the original forecasted values (green graph). Scenario SPI16 – Number of occurrences related to passenger handling – disembarking/embarking will remain the same (pink graph), in comparison to the original forecasted values (green graph). Scenario SPI17 – Number of occurrences related to personal protective equipment will increase (pink graph), in comparison to the original forecasted values (green graph). Scenario SPI18 – Number of aircraft chocking incidents will increase (pink graph), in comparison to the original forecasted values (green graph). Scenario SPI19 – Number of aircraft conning incidents will increase (pink graph), in comparison to the original forecasted values (green graph). Scenario SPI20 – Number of occurrences related to baggage loading/unloading will remain the same (pink graph), in comparison to the original forecasted values (green graph). Scenario SPI21 – Number of occurrences related to ground traffic (GSE) and vehicle driving will slightly increase (pink graph), in comparison to the original forecasted values (green graph). Scenario SPI22 – Number of anti-collision occurrences will remain the same (pink graph), in comparison to the original forecasted values (green graph). Scenario SPI23 – Number of engine start-up incidents will increase (pink graph), in comparison to the original forecasted values (green graph). Scenario SPI24 – Number of occurrences related to wildlife will slightly increase (pink graph), in comparison to the original forecasted values (green graph). Scenario SPI25 – Number of occurrences related to fuel handling will remain the same (pink graph), in comparison to the original forecasted values (green graph).



**Figure 139 Predicted safety performance indicators due to increased organisational indicator O12**  
*Source: Author using IBM SPSS Statistics*

### 8.5.4 Scenario 4 – Impact on safety performance indicators due to decrease of number of passengers

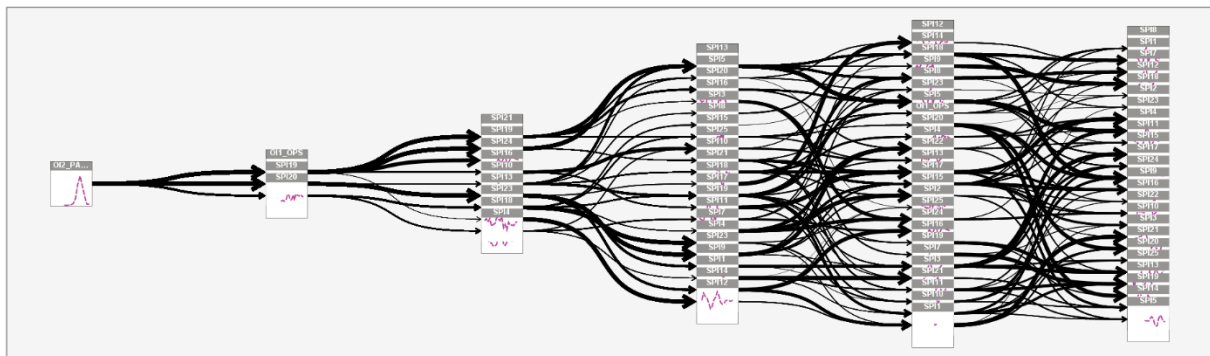
Fourth scenario shows decrease of organisational indicator OI2 – Number of passengers and its impact on safety performance indicators. Table 78 shows original values of OI2 and decreased values of OI2 for 30%, as well the graph.

**Table 78 Decrease of organisational indicator OI2 Number of passengers**

Time point	OI2_PASS initial	OI2_PASS decreased for 30%	Graph
Jan 2021	7415	5191	
Feb 2021	5706	3994	
Mar 2021	8031	5622	
Apr 2021	13964	9775	
May 2021	32754	22928	
Jun 2021	114687	80281	
Jul 2021	349042	244329	
Aug 2021	491358	343951	
Sep 2021	326347	228443	
Oct 2021	160720	112504	
Nov 2021	25726	18008	
Dec 2021	23428	16400	

Source: Author using IBM SPSS Statistics

Figure 140 shows impact diagram of decreased organisational indicator OI2 on all safety performance indicators.

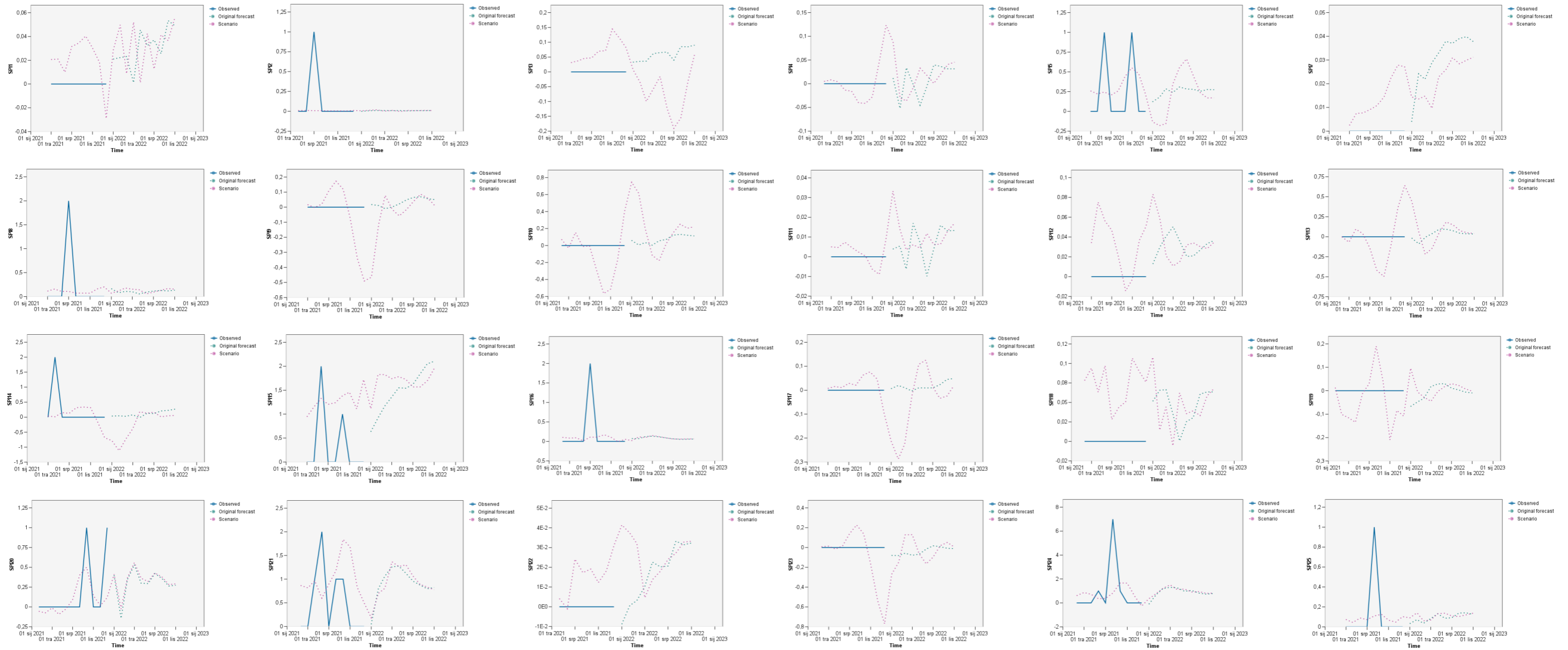


**Figure 140 Impact diagram of decreased organisational indicator OI2 on safety performance indicators**

Source: Author using IBM SPSS Statistics

Figure 141 shows that, due to decrease of 30% in organisational indicator OI2 – Number of passengers, scenario safety performance indicator SPI1 – Number of occurrences related to LIRF and loadsheet crosscheck will remain the same (pink graph), in comparison to the original forecasted values (green graph). Scenario SPI2 – Number of occurrences related to wrong figures for loadsheet will remain the same (pink graph), in comparison to the original forecasted values (green graph). Scenario SPI3 – Number of dangerous goods incidents will decrease (pink

graph), in comparison to the original forecasted values (green graph). Scenario SPI4 – Number of aircraft damage occurrences will increase (pink graph), in comparison to the original forecasted values (green graph). Scenario SPI5 – Number of personnel or passenger injuries will increase (pink graph), in comparison to the original forecasted values (green graph). Scenario SPI7 – Number of training deficiencies will decrease (pink graph), in comparison to the original forecasted values (green graph). Scenario SPI8 – Number of apron maintenance incidents will remain the same (pink graph), in comparison to the original forecasted values (green graph). Scenario SPI9 – Number of vehicle maintenance incidents will slightly decrease (pink graph), in comparison to the original forecasted values (green graph). Scenario SPI10 – Number of occurrences related to manoeuvring area maintenance will increase (pink graph), in comparison to the original forecasted values (green graph). Scenario SPI11 – Number of occurrences related to communication will increase (pink graph), in comparison to the original forecasted values (green graph). Scenario SPI12 – Number of incidents related to taxiing to/from apron will increase (pink graph), in comparison to the original forecasted values (green graph). Scenario SPI13 – Number of aircraft marshalling occurrences will increase (pink graph), in comparison to the original forecasted values (green graph). Scenario SPI14 – Number of occurrences related to FOD presence will decrease (pink graph), in comparison to the original forecasted values (green graph). Scenario SPI15 – Number of occurrences related to passenger handling at the gate will slightly decrease (pink graph), in comparison to the original forecasted values (green graph). Scenario SPI16 – Number of occurrences related to passenger handling – disembarking/embarking will remain the same (pink graph), in comparison to the original forecasted values (green graph). Scenario SPI17 – Number of occurrences related to personal protective equipment will remain the same (pink graph), in comparison to the original forecasted values (green graph). Scenario SPI18 – Number of aircraft chocking incidents will remain the same (pink graph), in comparison to the original forecasted values (green graph). Scenario SPI19 – Number of aircraft conning incidents will remain the same (pink graph), in comparison to the original forecasted values (green graph). Scenario SPI20 – Number of occurrences related to baggage loading/unloading will remain the same (pink graph), in comparison to the original forecasted values (green graph). Scenario SPI21 – Number of occurrences related to ground traffic (GSE) and vehicle driving will remain the same (pink graph), in comparison to the original forecasted values (green graph). Scenario SPI22 – Number of anti-collision occurrences will remain the same (pink graph), in comparison to the original forecasted values (green graph). Scenario SPI23 – Number of engine start-up incidents will remain the same (pink graph), in comparison to the original forecasted values (green graph). Scenario SPI24 – Number of occurrences related to wildlife will remain the same (pink graph), in comparison to the original forecasted values (green graph). Scenario SPI25 – Number of occurrences related to fuel handling will remain the same (pink graph), in comparison to the original forecasted values (green graph).



**Figure 141 Predicted safety performance indicators due to decreased organisational indicator O12**  
 Source: Author using IBM SPSS Statistics



## 8.6 Expanded set of safety performance indicators for Split Airport

In the case of Split Airport, as described in 8.1, there are 25 defined safety performance indicators (SPIs) that each measure designated part of airport business, i.e., its safety-related outcomes. Each of them gives a piece of information related to operator's safety performance. More pieces of safety-relevant information provides even better view of airport safety performance.

In 8.1, 25 defined safety performance indicators (SPIs) are the following: SPI1 – Number of occurrences related to LIRF and loadsheet crosscheck, SPI2 – Number of occurrences related to wrong figures for loadsheet, SPI3 – Number of dangerous goods incidents, SPI4 – Number of aircraft damage occurrences, SPI5 – Number of personnel or passenger injuries, SPI6 – Number of runway incursions/excursions, SPI7 – Number of training deficiencies, SPI8 – Number of apron maintenance incidents, SPI9 – Number of vehicle maintenance incidents, SPI10 – Number of occurrences related to manoeuvring area maintenance, SPI11 – Number of occurrences related to communication, SPI12 – Number of incidents related to taxiing to/from apron, SPI13 – Number of aircraft marshalling occurrences, SPI14 – Number of occurrences related to FOD presence, SPI15 – Number of occurrences related to passenger handling at the gate, SPI16 – Number of occurrences related to passenger handling – disembarking/embarking, SPI17 – Number of occurrences related to personal protective equipment, SPI18 – Number of aircraft chocking incidents, SPI19 – Number of aircraft conning incidents, SPI20 – Number of occurrences related to baggage loading/unloading, SPI21 – Number of occurrences related to ground traffic (GSE) and vehicle driving, SPI22 – Number of anti-collision occurrences, SPI23 – Number of engine start-up incidents, SPI24 – Number of occurrences related to wildlife, SPI25 – Number of occurrences related to fuel handling.

Due to analysis of registered occurrences at the targeted airport, i.e., Split Airport, and in cooperation of Split Airport Safety Department, new occurrences have been detected related to the medical emergency landings at the airport, and they were observed recently, i.e., from May 2022 to June 2022. The safety performance indicator has not yet been assigned to this area, but the events had been recorded. It is assumed that these events affect safety and that it would be useful to monitor them via safety performance indicator in the future.

To prove that new safety performance indicator is relevant to safety and impacts other areas of airport operations, predictive safety management methodology developed in this research, is used. Causal modelling methods can detect impact relations of newly established indicator with other areas of airport operations, and predictive methods can anticipate reoccurrence of the same in the observed future period. Table 79 shows the dataset of organisational indicators (OIs) and safety performance indicators (SPIs) at the Split Airport including newly established safety performance indicator SPI26 – Number of occurrences related to medical emergency landings.

**Table 79 Dataset of organisational indicators (OIs) and safety performance indicators (SPIs) at the Split Airport including newly established SPI26**

Month-Year	O1	O2	SPI1	SPI2	SPI3	SPI4	SPI5	SPI6	SPI7	SPI8	SPI9	SPI10	SPI11	SPI12	SPI13	SPI14	SPI15	SPI16	SPI17	SPI18	SPI19	SPI20	SPI21	SPI22	SPI23	SPI24	SPI25	SPI26
Jan-14	438	24900	0	0	0	0	0	0	0	0	0	0	0	0	0	0	0	0	0	0	0	0	1	0	0	0	0	0
Feb-14	392	20825	0	0	0	0	0	0	0	0	0	0	0	0	0	0	0	0	1	0	0	1	0	0	0	0	0	0
Mar-14	514	26410	0	0	0	0	0	0	0	0	0	0	0	0	0	1	0	0	0	0	0	1	1	0	0	1	0	0
Apr-14	1032	77575	0	0	0	0	0	0	0	2	0	4	1	0	0	0	0	0	0	0	0	0	1	0	0	0	0	0
May-14	1942	157070	0	0	0	0	0	0	0	1	0	0	0	0	0	0	0	1	0	0	0	0	1	0	0	1	0	0
Jun-14	2554	234139	0	0	0	0	2	0	0	1	0	0	0	0	1	1	1	0	1	0	0	1	6	0	0	0	0	0
Jul-14	3872	386039	0	0	1	0	1	0	0	0	0	0	0	0	1	0	5	0	0	0	0	0	1	0	0	10	0	0
Aug-14	3954	389032	0	0	0	0	0	0	0	0	1	1	0	0	0	0	0	1	0	0	0	0	3	0	1	1	0	0
Sep-14	2592	240991	0	0	0	1	0	0	0	1	1	0	0	0	0	1	2	0	0	0	0	1	0	0	1	2	0	0
Oct-14	1470	114161	0	0	0	0	0	0	0	1	0	0	0	0	0	0	0	0	0	0	0	0	1	0	0	2	0	0
Nov-14	504	27359	0	0	0	0	0	0	0	0	0	0	0	0	0	0	0	0	0	0	0	0	0	0	0	0	0	0
Dec-14	528	30811	0	0	0	0	0	0	0	0	0	0	0	0	0	0	0	0	0	0	0	0	0	0	0	0	0	0
Jan-15	504	23513	0	0	0	0	0	0	0	0	0	1	0	0	0	0	0	0	0	0	0	0	0	0	0	0	0	0
Feb-15	454	22234	0	0	0	0	0	0	0	0	0	0	0	0	0	0	0	0	0	0	0	0	2	0	0	0	0	0
Mar-15	576	31941	0	0	0	0	0	0	0	0	0	0	0	0	0	1	0	0	0	0	0	0	0	0	0	0	0	0
Apr-15	1132	73149	0	0	0	0	0	0	0	0	0	0	0	0	1	0	2	0	0	0	0	0	1	0	0	2	0	0
May-15	2232	179794	0	0	1	0	0	0	0	0	1	0	0	0	0	0	1	0	0	0	0	0	1	0	1	0	0	0
Jun-15	2942	267755	0	0	0	0	0	0	0	1	0	0	0	0	0	0	1	1	0	0	0	2	1	0	1	1	0	0
Jul-15	4374	431014	1	0	1	1	1	0	0	0	0	0	0	0	0	1	10	0	0	0	0	1	3	0	0	4	1	0
Aug-15	4162	427830	0	0	0	0	1	0	0	0	0	0	0	0	0	0	10	0	1	0	0	0	2	0	0	3	0	0
Sep-15	2826	285446	0	0	0	0	1	0	0	1	0	0	0	0	0	0	6	0	0	0	0	0	1	0	0	0	0	0
Oct-15	1582	133129	0	0	0	0	0	0	0	1	0	0	0	0	0	0	2	0	0	0	0	0	1	0	0	0	0	0
Nov-15	640	27938	0	0	0	0	0	0	0	0	1	0	0	0	0	0	0	0	0	0	0	0	0	0	0	0	0	0
Dec-15	564	27137	0	0	0	0	0	0	0	1	0	0	0	0	0	1	0	0	0	0	0	0	0	0	0	0	0	0
Jan-16	492	25028	0	0	0	0	0	0	0	0	0	0	0	0	0	0	0	0	0	0	0	0	1	0	0	0	0	0
Feb-16	494	22782	0	0	0	0	0	0	0	0	1	0	0	0	0	0	0	0	0	0	0	0	3	0	0	1	0	0
Mar-16	624	33477	1	0	0	0	1	0	1	0	0	0	0	0	0	0	1	0	0	0	0	0	0	0	0	0	0	0
Apr-16	1142	73764	0	0	0	0	0	0	0	0	0	0	0	0	0	0	1	0	0	0	0	0	1	0	0	0	0	0
May-16	2390	201906	0	0	1	0	2	0	1	0	0	0	0	0	0	0	6	0	1	0	0	1	2	0	0	2	0	0
Jun-16	3148	319135	0	0	1	0	0	0	0	0	0	0	0	0	0	0	14	0	0	0	0	2	3	0	0	1	1	0
Jul-16	4824	540778	0	0	0	0	1	0	0	0	1	0	0	0	0	0	16	0	0	0	0	0	3	0	0	0	0	0
Aug-16	4518	483215	0	0	0	1	1	0	0	1	0	0	0	0	0	0	15	1	0	0	0	1	3	0	0	0	1	0
Sep-16	3280	337967	0	0	0	0	1	0	0	1	0	0	1	0	1	0	5	0	0	0	0	3	5	1	0	2	2	0
Oct-16	1876	165299	0	0	0	0	0	0	0	0	0	0	0	0	0	0	2	0	0	0	0	2	1	0	0	1	0	0
Nov-16	582	30676	0	0	0	0	0	0	0	0	0	0	0	0	0	0	0	0	0	0	0	0	1	0	0	0	0	0
Dec-16	570	28779	0	0	0	0	0	0	0	0	0	0	0	0	0	0	2	0	0	0	0	0	0	0	0	0	0	0
Jan-17	586	28994	0	0	0	1	0	0	0	0	0	1	0	0	0	0	0	1	0	0	0	0	0	0	0	0	0	0
Feb-17	496	22646	0	0	0	0	0	0	0	0	0	0	0	0	0	0	0	0	0	1	0	0	0	0	0	1	1	0
Mar-17	640	31878	1	0	0	0	0	0	0	0	0	0	0	0	0	0	0	0	0	0	0	0	0	0	0	1	1	0
Apr-17	1378	120980	0	0	0	0	0	0	0	0	0	0	0	0	0	0	1	0	0	0	0	0	0	0	0	1	0	0
May-17	2644	254265	0	0	0	0	1	0	0	0	1	0	0	0	0	0	3	0	0	0	0	0	1	0	0	3	0	0
Jun-17	3594	401347	0	0	0	0	0	0	0	0	0	0	0	0	0	0	6	0	0	0	0	0	5	1	0	0	1	0
Jul-17	5216	653743	0	0	0	0	3	0	0	0	0	0	0	0	0	0	7	0	0	0	0	0	0	0	0	2	0	0
Aug-17	5078	590830	0	0	0	0	0	0	0	1	0	0	0	0	0	0	0	0	0	0	0	0	4	0	0	3	0	0
Sep-17	378	418836	0	0	0	0	0	0	0	0	0	0	0	0	0	0	1	0	0	0	0	0	0	0	0	4	1	0
Oct-17	2116	195837	0	0	0	0	0	0	0	0	0	0	0	0	0	0	1	0	0	1	1	0	0	0	0	1	1	0
Nov-17	654	37343	0	0	0	0	0	0	0	0	0	1	0	0	1	0	0	0	0	0	0	0	0	0	0	0	0	0
Dec-17	554	34626	0	0	0	0	0	0	0	0	0	0	0	0	0	0	0	0	0	0	0	0	0	0	0	0	0	0
Jan-18	590	32006	0	0	0	0	0	0	0	0	0	1	0	0	0	0	0	0	0	0	0	0	1	0	0	0	0	0
Feb-18	520	29109	0	0	0	0	0	0	0	0	0	1	0	0	0	1	0	0	0	2	0	0	0	0	0	1	0	0
Mar-18	748	51331	0	0	0	0	0	0	0	0	0	1	0	1	0	0	0	0	0	0	0	0	2	0	0	0	0	0
Apr-18	1486	121372	0	0	0	0	0	0	0	0	0	0	0	0	0	0	1	0	0	0	0	1	1	0	0	2	0	0
May-18	2878	301377	0	0	0	0	0	0	0	0	0	0	0	0	0	0	5	0	0	0	0	0	1	0	0	0	0	0
Jun-18	4052	471962	0	0	0	0	0	0	0	0	0	0	0	0	0	0	2	0	0	0	0	0	0	0	0	0	1	0
Jul-18	5504	691810	0	0	0	0	1	0	0	0	0	0	0	0	0	0	6	0	0	0	0	2	8	0	0	1	0	0
Aug-18	5136	625209	0	0	0	0	0	0	0	0	0	1	0	0	1	0	5	1	0	0	0	3	0	0	0	3	0	0
Sep-18	3842	452964	0	0	0	0	0	0	0	0	0	0	0	0	0	0	4	0	1	0	0	0	3	0	0	4	0	0
Oct-18	2272	223092	0	0	0	0	2	0	0	0	1	0	0	0	0	0	5	0	0	0	0	1	1	1	0	0	0	0

Nov-18	750	52942	0	0	0	0	0	0	0	0	0	0	0	0	0	2	0	0	0	0	0	1	0	0	0	0	0	0	
Dec-18	646	42434	0	0	0	0	0	0	0	0	0	0	0	0	0	0	0	0	0	0	0	0	0	0	0	0	0	0	
Jan-19	664	34694	0	0	0	0	0	0	0	0	0	0	0	0	0	0	0	0	0	0	0	0	0	0	0	0	0	0	
Feb-19	634	33087	0	0	0	0	0	0	0	0	0	0	0	0	0	0	0	0	0	0	0	3	0	0	0	0	0	0	
Mar-19	800	48095	0	0	0	0	0	0	1	0	0	0	0	1	0	0	0	0	0	0	0	0	0	0	0	0	0	0	
Apr-19	1698	153474	0	0	0	0	0	0	0	0	0	0	0	1	0	4	0	0	0	0	0	0	1	0	0	1	0	0	
May-19	2992	308447	0	0	0	0	1	0	0	0	0	0	0	0	1	0	0	0	0	0	0	1	0	0	2	0	0	0	
Jun-19	4318	510438	0	0	0	0	0	0	0	0	0	0	0	0	5	0	0	0	0	0	1	1	0	0	2	0	0	0	
Jul-19	5576	719796	2	0	1	0	1	0	0	0	0	0	0	0	1	0	0	0	0	0	0	2	0	0	13	0	0	0	
Aug-19	5320	669403	0	0	0	0	0	0	1	0	1	0	0	0	2	2	0	0	0	0	1	2	0	0	5	0	0	0	
Sep-19	3848	467544	0	0	0	0	0	0	0	0	0	0	0	0	0	0	0	0	0	1	0	0	0	0	0	0	0	0	
Oct-19	2372	244259	0	0	3	0	0	0	0	0	2	0	0	0	1	0	0	0	0	0	0	4	0	0	0	0	0	0	0
Nov-19	634	42859	0	0	1	0	0	0	0	0	0	0	0	0	2	0	0	0	0	0	0	0	0	0	1	0	0	0	
Dec-19	574	38949	0	0	0	0	0	0	0	0	0	0	0	0	2	0	0	0	0	0	0	1	0	0	0	0	0	0	
Jan-20	567	35282	0	0	0	0	0	0	0	0	0	0	0	0	0	0	0	0	0	0	0	1	0	0	0	0	0	0	
Feb-20	474	24606	0	0	0	0	0	0	0	0	0	0	0	0	0	0	0	0	0	0	0	0	0	0	0	0	0	0	
Mar-20	370	16117	0	0	0	0	0	0	0	0	0	0	0	0	0	0	0	0	0	0	0	0	0	0	0	0	0	0	
Apr-20	16	0	0	0	0	0	0	0	1	0	0	0	0	0	0	0	0	0	0	0	0	0	0	0	0	0	0	0	
May-20	194	2319	0	0	0	0	0	0	0	0	0	0	0	0	0	0	0	0	0	0	0	0	0	0	0	0	0	0	
Jun-20	818	24929	0	0	0	0	0	0	0	0	0	0	0	0	0	2	0	0	1	0	0	0	0	0	1	0	0	0	
Jul-20	2757	169229	0	0	0	0	3	0	0	0	0	0	0	0	0	11	1	0	0	0	0	1	0	0	6	0	0	0	
Aug-20	3676	271362	1	0	0	0	0	0	0	0	0	0	1	0	0	7	0	0	0	0	0	0	0	0	0	0	0	0	
Sep-20	1807	74653	0	0	0	0	0	0	0	0	0	0	0	0	2	0	0	0	0	0	1	0	0	1	0	0	0	0	
Oct-20	720	25050	0	0	0	0	0	0	0	0	0	0	0	0	1	0	0	0	0	0	0	0	0	0	1	1	0	0	
Nov-20	410	7658	0	0	1	0	0	0	0	0	0	0	0	0	0	0	0	0	0	0	0	0	0	0	0	0	0	0	
Dec-20	341	8145	0	0	0	0	0	0	0	0	0	0	0	0	0	0	0	0	0	0	0	0	0	0	0	0	0	0	
Jan-21	314	7415	0	0	0	0	0	0	0	0	0	0	0	0	0	0	0	0	0	0	0	0	0	0	0	0	0	0	
Feb-21	274	5706	0	0	0	0	0	0	0	0	0	0	0	0	0	0	0	0	0	0	0	0	0	0	0	0	0	0	
Mar-21	358	8031	0	0	0	0	0	0	0	0	0	0	0	0	0	0	0	0	0	0	0	0	0	0	0	0	0	0	
Apr-21	587	13964	0	0	0	0	0	0	0	0	0	0	0	0	0	0	0	0	0	0	0	0	0	0	0	0	0	0	
May-21	883	32754	0	0	0	0	0	0	0	0	0	0	0	0	2	0	0	0	0	0	0	1	0	0	0	0	0	0	
Jun-21	2051	114687	0	0	0	0	1	0	0	0	0	0	0	0	0	2	0	0	0	0	0	2	0	0	1	0	0	0	
Jul-21	4084	349042	0	1	0	0	0	0	2	0	0	0	0	0	0	0	2	0	0	0	0	0	0	0	0	0	0	0	
Aug-21	4728	491358	0	0	0	0	0	0	0	0	0	0	0	0	0	0	0	0	0	0	1	0	0	7	1	0	0	0	
Sep-21	3435	326347	0	0	0	0	0	0	0	0	0	0	0	0	1	0	0	0	0	1	1	0	0	1	0	0	0	0	
Oct-21	2090	160720	0	0	0	0	1	0	0	0	0	0	0	0	0	0	0	0	0	0	0	0	0	0	0	0	0	0	
Nov-21	613	25726	0	0	0	0	0	0	0	0	0	0	0	0	0	0	0	0	0	0	0	0	0	0	0	0	0	0	
Dec-21	615	23428	0	0	0	0	0	0	0	0	0	0	0	0	0	0	0	0	0	1	0	0	0	0	0	0	0	0	
Jan-22	572	20400	0	0	0	0	0	0	0	0	1	0	0	0	1	0	0	0	0	0	0	0	0	0	0	0	0	0	
Feb-22	519	19678	0	0	0	0	0	0	0	0	0	0	0	0	0	0	0	0	0	0	0	0	0	0	0	0	0	0	
Mar-22	753	32445	0	0	0	0	0	0	0	0	0	0	0	0	0	1	0	0	0	0	0	0	0	0	0	0	0	0	
Apr-22	1657	133316	0	0	0	1	0	0	1	0	1	0	0	0	0	0	0	0	0	0	1	0	0	0	0	0	0	0	
May-22	2560	251341	1	1	0	0	0	0	0	0	1	0	0	0	0	0	0	0	0	0	1	0	0	3	0	0	1	0	
Jun-22	2854	422419	0	0	0	0	0	0	0	0	1	0	0	0	0	0	0	0	0	0	1	0	0	3	0	0	3	0	
Jul-22	5160	641982	0	0	0	0	0	0	0	0	0	0	0	0	1	0	1	0	0	0	4	0	0	1	0	0	0	0	

Source: Author according to (Split Airport, 2022)

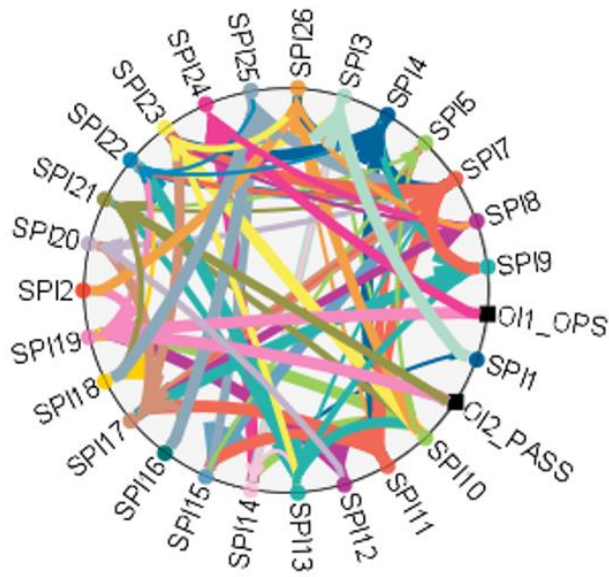
To obtain impact relations between organisational and safety performance indicators, IBM SPSS function „Temporal Causal Modelling” was used. The set-up was made in such way that independent variables are organisational indicators (OIs), i.e., OIs are set to be „inputs” in temporal causal model, and safety performance indicators (SPIs) are dependent and independent variables, i.e., SPIs are set to be „both inputs and targets”. The new safety performance indicator SPI26 – Number of occurrences related to medical emergency landings is added in the analysis. SPI6 model was excluded due to the fact that values are constant, i.e., equal to 0. Table 80 shows fit statistics for top causal models generated for each of 25 safety performance indicators of Split Airport, including newly established safety performance indicator SPI26 – Number of occurrences related to medical emergency landings.

**Table 80 Fit statistics for top causal models including newly established SPI26**

Target Model	Model Quality				
	RMSE	RMSPE	AIC	BIC	R-squared
SPI1	0.26	0.17	-242.91	-175.70	0.43
SPI2	0.14	0.11	-356.98	-289.77	0.23
SPI3	0.26	0.16	-240.34	-173.13	0.69
SPI4	0.14	0.10	-359.60	-292.40	0.69
SPI5	0.53	0.23	-102.18	-34.98	0.45
SPI7	0.09	0.05	-441.65	-374.44	0.68
SPI8	0.35	0.20	-186.47	-119.26	0.44
SPI9	0.21	0.14	-281.86	-214.65	0.56
SPI10	0.28	0.19	-228.70	-161.49	0.62
SPI11	0.05	0.02	-576.16	-508.95	0.84
SPI12	0.15	0.11	-356.45	-289.24	0.48
SPI13	0.19	0.12	-306.55	-239.35	0.61
SPI14	0.65	0.23	-63.00	4.21	0.49
SPI15	1.87	0.41	144.72	211.93	0.77
SPI16	0.31	0.18	-205.76	-138.55	0.36
SPI17	0.14	0.08	-362.46	-295.25	0.63
SPI18	0.15	0.11	-343.88	-276.67	0.74
SPI19	0.04	0.01	-600.61	-533.40	0.87
SPI20	0.46	0.21	-131.16	-63.95	0.62
SPI21	1.11	0.40	42.55	109.76	0.59
SPI22	0.13	0.08	-375.45	-308.24	0.57
SPI23	0.10	0.07	-425.79	-358.58	0.81
SPI24	1.43	0.47	91.87	159.08	0.65
SPI25	0.23	0.13	-270.56	-203.35	0.73
<b>SPI26</b>	<b>0.33</b>	<b>0.11</b>	<b>-195.24</b>	<b>-128.03</b>	<b>0.73</b>

Source: Author using IBM SPSS Statistics

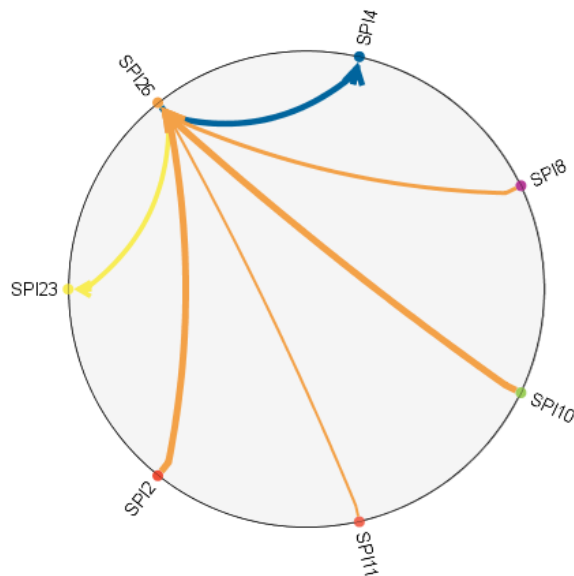
Figure 142 shows causal model of all relations between organisational indicators (OIs) and safety performance indicators (SPIs) at the Split Airport, including newly established safety performance indicator SPI26 – Number of occurrences related to medical emergency landings.



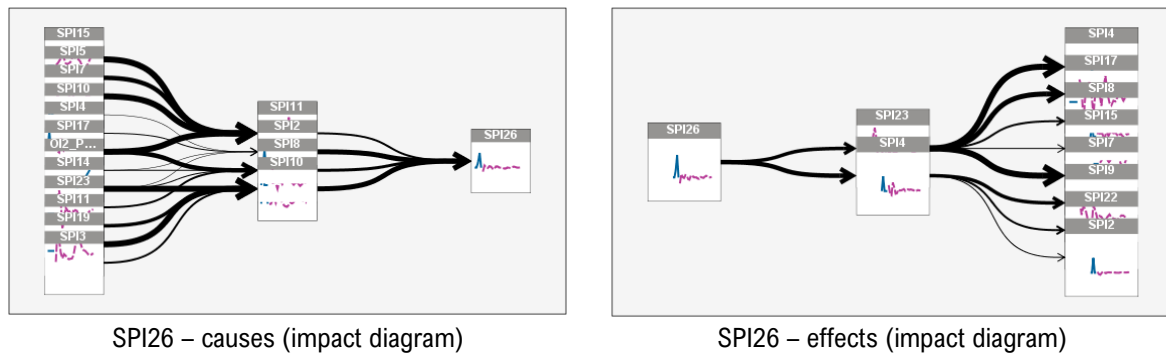
**Figure 142 Causal model of Split Airport organisational and safety performance indicators including new safety performance indicator**

*Source: Author using IBM SPSS Statistics*

Figure 143 shows impact relations of newly established safety performance indicators (SPI26 – Number of occurrences related to medical emergency landings) at the Split Airport, i.e., impact diagrams of cause-effect relations.



Impact relations of SPI26



**Figure 143 Impact of newly established safety performance indicator**

*Source: Author using IBM SPSS Statistics*

Next step would include forecasting for newly established safety performance indicator, i.e., SPI26 – Number of occurrences related to medical emergency landings, using the IBM SPSS Statistics software function “Forecasting”. This part would not be performed due to lack of data in the dataset of newly established safety performance indicator, i.e., SPI26 – Number of occurrences related to medical emergency landings. Forecasting cannot be conducted with accuracy and reliability but monitoring these events in the future and gathering data will give better base for future forecasting of the same.

Analysis of newly established safety performance indicator SPI26 – Number of occurrences related to medical emergency landings, using predictive and causal modelling methods showed that detected SPI impacts six other safety performance indicators, i.e. SPI2 – Number of occurrences related to wrong figures for loadsheet, SPI4 – Number of aircraft damage occurrences, SPI8 – Number of apron maintenance incidents, SPI10 – Number of occurrences related to manoeuvring area maintenance, SPI11 – Number of occurrences related to communication, and SPI23 – Number of engine start-up incidents. Causal model detected that SPI26 – Number of occurrences related to medical emergency landings, is directly caused by SPI2 – Number of occurrences related to wrong figures for loadsheet, SPI8 – Number of apron maintenance incidents, SPI10 – Number of occurrences related to manoeuvring area maintenance, and SPI11 – Number of occurrences related to communication. It detected, as well, that SPI26 – Number of occurrences related to medical emergency landings, directly impacts (affects) events in area SPI4 – Number of aircraft damage occurrences, and SPI23 – Number of engine start-up incidents. By finding causal relations (impacts) of newly established safety performance indicator SPI26 – Number of occurrences related to medical emergency landings, it is proven that occurrences related to newly established area of safety performance monitoring (SPI26 – Number of occurrences related to medical emergency landings) is relevant to safety performance and therefore worth tracking in the future. Hence, including newly established safety performance indicator SPI26 – Number of occurrences related to medical emergency landings, into the existing set of safety performance indicators, it can be concluded that total set of safety performance indicators at the Split Airport, has been expanded.

What is learned by causal model of new SPI26 – Number of occurrences related to medical emergency landings, and its impact relations, specifically in the areas which are detected as “causes of SPI26”, i.e., the areas of SPI2 – Number of occurrences related to wrong figures for

loadsheets, SPI8 – Number of apron maintenance incidents, SPI10 – Number of occurrences related to manoeuvring area maintenance, and SPI11 – Number of occurrences related to communication, is useful to define and implement some mitigative measures to ensure better safety performance. Table 81 shows the overview of proposed mitigation measures to mitigate newly emerged occurrences related to medical emergency landings.

**Table 81 Proposed mitigation measures for newly established SPI26**

Detected causal factors (SPIs)	Area of causal impact	Proposed mitigation measure/ action
SPI2	Wrong figures for loadsheet	<ol style="list-style-type: none"> <li>1. Conduct inspection related to wrong figures on loadsheet; check whether the procedures are carried out in accordance with the regulations; established findings can reveal omissions and help define specific mitigation measures.</li> <li>2. Check whether the personnel who carry loadsheet crosscheck is qualified to perform the tasks, and whether all refreshers are carried out on time.</li> <li>3. Check in particular whether all employees have undergone training in the field of safety and human factors, and whether they are familiar with all safety problems in their field of work.</li> <li>4. Check the accuracy of all data on the loadsheet, i.e., destination, flight number, registration, aircraft type, crew and flight date, and whether it is correctly signed by the responsible persons.</li> <li>5. Check the accuracy of entered operating weights and the weight of passengers and baggage.</li> <li>6. Check the correctness of other documentation according to prescribed requirements.</li> </ol>
SPI8	Apron maintenance	<ol style="list-style-type: none"> <li>1. Conduct inspection in the area of apron maintenance; check whether the procedures related to apron maintenance are carried out in accordance with the regulations; established findings can reveal omissions and help define specific mitigation measures.</li> <li>2. Check whether the personnel who carry out procedures related to apron maintenance is qualified to perform the tasks, and whether all refreshers are carried out on time.</li> <li>3. Check in particular whether all employees have undergone training in the field of safety and human factors, and whether they are familiar with all safety problems in their field of work.</li> <li>4. Check whether there is major damage to the pavement of the apron area.</li> <li>5. Check whether there are one or more foreign objects on the pavement of the apron that may endanger the safety of the aircraft (FOD).</li> <li>6. Check whether there are greasy stains from lubricants, motor oil, fuel or the like on the pavement of the apron.</li> </ol>
SPI10	Manoeuvring area maintenance	<ol style="list-style-type: none"> <li>1. Conduct inspection in the manoeuvring area maintenance; check whether the procedures in the manoeuvring area maintenance are carried out in accordance with the regulations; established findings can reveal omissions and help define specific mitigation measures.</li> <li>2. Check whether the personnel who carry out procedures in the manoeuvring area maintenance is qualified to perform the tasks, and whether all refreshers are carried out on time.</li> <li>3. Check in particular whether all employees have undergone training in the field of safety and human factors, and whether they are familiar with all safety problems in their field of work.</li> </ol>

		<ol style="list-style-type: none"> <li>4. Check whether there is major damage to the pavement of the manoeuvring area.</li> <li>5. Check whether there are one or more foreign objects on the pavement of the manoeuvring area that may endanger the safety of the aircraft (FOD).</li> <li>6. Check whether there are greasy stains from lubricants, motor oil, fuel or the like on the pavement of the manoeuvring area.</li> <li>7. Check the correctness of horizontal and vertical signalisation on the manoeuvring area.</li> <li>8. Check whether all vehicles, means and equipment are placed in their designated places.</li> </ol>
SPI11	Communication	<ol style="list-style-type: none"> <li>1. Conduct inspection in the communication-related equipment, personnel and procedures; check whether the procedures are carried out in accordance with the regulations; established findings can reveal omissions and help define specific mitigation measures.</li> <li>2. Check whether the personnel who carry out procedures is qualified to perform the tasks, and whether all refreshers are carried out on time.</li> <li>3. Check in particular whether all employees have undergone training in the field of safety and human factors, and whether they are familiar with all safety problems in their field of work.</li> <li>4. Inspect the technical fitness of communication equipment and systems.</li> <li>5. Check whether there are language barriers in communication and transfer of information.</li> </ol>

*Source: Author*

Another proposal of expanding set of safety performance indicators (SPIs) is to divide existing set of safety performance indicators (SPIs) into even more specific parts, and, by doing so, obtain more pieces of safety-relevant information. Each safety performance indicator measures designated part of airport business, i.e., its safety-related outcomes, and gives a piece of information related to operator's safety performance in that designated area. Hence, by dividing existing set of safety performance indicators (SPIs) into more specific areas of business, insights could be obtained in which area of business the concentration of most safety-related problems, is located, and therefore manage that area with more attention. Targeted airport could therefore describe occurrences that happen in each area of concern, i.e., in relation to personnel, equipment/vehicles or management/planning. Hence, additional safety performance indicators could be set up in relation to human factors, technical factors or organisational factors. For example, SPI4 – Number of aircraft damage occurrences, could be divided into three additional areas of concern inside the general area of monitoring "aircraft damage occurrences", i.e., SPI4a – Number of aircraft damage occurrences due to human factors, SPI4b – Number of aircraft damage occurrences due to technical factors, and SPI4c – Number of aircraft damage occurrences due to organisational factors.



## **8.7 Summary of results and proposal of mitigation measures based on predictive safety management methodology for Split Airport**

In the first step, analysis showed which areas of dataset are most critical in observed time period from January 2014 until December 2021, i.e., SPI15 – Number of occurrences related to passenger handling at the gate (which even reached 16 occurrences per month in 2016), SPI21 – Number of occurrences related to ground traffic (GSE) and vehicle driving (which reached 8 occurrences per month in 2018), and SPI24 – Number of occurrences related to wildlife (which even reached 13 occurrences per month in 2019).

In second step, causal modelling of organisational and safety performance indicators was performed, using IBM SPSS Statistics and function called Temporal Causal Model. With this model, causal relations were detected among each dataset of organisational and safety performance indicators at the Split Airport. Causal relations of individual organisational indicators (OIs) and safety performance indicators (SPIs) at the Split Airport, revealed which indicator influence the others the most, i.e., SPI7 – Number of training deficiencies, SPI13 – Number of aircraft marshalling occurrences, SPI17 – Number of occurrences related to personal protective equipment, SPI21 – Number of occurrences related to ground traffic (GSE) and vehicle driving, and SPI23 – Number of engine start-up incidents. Each of these impacts 6 or more other indicators. This suggests that certain mitigation measures should be implemented in these areas of airport operations, to generally prevent adverse effects. It can also be observed that all of these areas are related to the human factor element, hence measures such as additional training and more frequent inspections could be possible solution for mitigating deficiencies in detected areas.

In third step, outlier root cause analysis was performed (8.3), to analyse more closely outliers, which in fact represent extreme values of indicators, and which are in fact, of most interest to any operator because those extreme values (outliers) are exactly the ones that are of most concern to an operator and exactly the ones any operator wishes to mitigate. Applying root cause analysis of outliers can be very useful to determine which indicators caused these extreme values in order to mitigate or prevent them in the future. Outlier root cause analysis also revealed which indicators influence the others the most and helped to map out the path of each occurrence over the timeline, i.e., SPI7 – Number of training deficiencies, SPI10 – Number of occurrences related to manoeuvring area maintenance, SPI13 – Number of aircraft marshalling occurrences, SPI21 – Number of occurrences related to ground traffic (GSE) and vehicle driving, and SPI23 – Number of engine start-up incidents.

Next step was performing forecasting (prediction) of each organisational and safety performance indicator, using the IBM SPSS Statistics software. Forecasting of indicators is conducted using function „Expert Modeler” and „Forecasting using Temporal Causal Model” (8.4). Three sets of forecasts are made, and the best fit was obtained by using exponential smoothing methods with seasonal component. The significant events (ones that also showed they might cross safety performance target levels) are predicted to occur in July 2022 and July 2023, in the area SPI15 – Number of occurrences related to passenger handling at the gate, and

in September 2022 and September 2023, in the area SPI24 – Number of occurrences related to wildlife. Other events are predicted to happen in areas SPI5 – Number of personnel or passenger injuries, SPI14 – Number of occurrences related to FOD presence, SPI20 – Number of occurrences related to baggage loading/unloading, and SPI21 – Number of occurrences related to ground traffic (GSE) and vehicle driving. All of these are anticipated in summer months when the airport is the busiest, so more attention and additional mitigation measures should be implemented in these areas.

To mitigate or prevent anticipated occurrences, it is useful to use detected obtained causes that impact future events. Hence, per causal model in 8.2, SPI5 – Number of personnel or passenger injuries is impacted by SPI10 – Number of occurrences related to manoeuvring area maintenance, SPI15 – Number of occurrences related to passenger handling at the gate and SPI21 – Number of occurrences related to ground traffic (GSE) and vehicle driving. SPI14 – Number of occurrences related to FOD presence is impacted by SPI3 – Number of dangerous goods incidents, SPI11 – Number of occurrences related to communication and SPI13 – Number of aircraft marshalling occurrences. SPI15 – Number of occurrences related to passenger handling at the gate is impacted by SPI7 – Number of training deficiencies, SPI21 – Number of occurrences related to ground traffic (GSE) and vehicle driving and SPI23 – Number of engine start-up incidents. SPI20 – Number of occurrences related to baggage loading/unloading is impacted by SPI7 – Number of training deficiencies, SPI21 – Number of occurrences related to ground traffic (GSE) and vehicle driving and OI2 – Number of passengers. SPI21 – Number of occurrences related to ground traffic (GSE) and vehicle driving is impacted by SPI1 – Number of occurrences related to LIRF and loadsheet crosscheck, SPI10 – Number of occurrences related to manoeuvring area maintenance and OI1 – Number of aircraft operations. SPI24 – Number of occurrences related to wildlife is impacted by SPI11 – Number of occurrences related to communication, SPI14 – Number of occurrences related to FOD presence and OI1 – Number of aircraft operations. All impacts are shown in Figure 144.

After conducting forecasting of each indicator at the Split Airport, predictive analysis of safety performance indicators was performed (8.5), i.e., four scenario analyses were conducted to show how different values of organisational indicators (lower or higher than original values), due to established causal relations, would impact future occurrences (SPIs) at Split Airport. Two organisational indicators were available for analysis, i.e., OI1 – Number of aircraft operations and OI2 – Number of passengers. Two scenarios were made for each organisational indicator (increase and decrease for 30%) to see how they will impact safety performance indicators. Since forecasts of OI1 and OI2 both anticipate an increase, scenarios showing how increased OI1 and OI2 impact SPIs, can be useful. Due to increase of OI1 – Number of aircraft operations, it can be observed that SPI1, SPI3, SPI4, SPI8, SPI9, SPI10, SPI11, SPI12, SPI13, SPI14, SPI17, SPI18, SPI23, SPI24 would decrease, SPI2, SPI5, SPI16, SPI19, SPI20, SPI21, SPI22, SPI25 would approximately remain the same, and only SPI7 and SPI15 are detected to be increased. Additional attention should be paid to these anticipated areas of increased occurrences. Due to increase of OI2 – Number of passengers, it can be observed that SPI1, SPI3, SPI4, SPI5, SPI9, SPI10, SPI11, SPI12, SPI14, SPI15, SPI17, SPI18, SPI19, SPI21, SPI23, SPI24 would increase, SPI2, SPI8, SPI13, SPI16, SPI20, SPI22, SPI25 would approximately remain the same, and only SPI7 is detected to be decreased. Additional attention should be paid to these anticipated areas

of increased occurrences. These two organisational indicators have opposite effects on safety performance indicators, hence in summary, attention should be paid to SPI5 – Number of personnel or passenger injuries, SPI8 – Number of apron maintenance incidents, and SPI15 – Number of occurrences related to passenger handling at the gate. Analysis of additional organisational indicators could show further what happens with safety performance indicators.

Last part presented how predictive and causal modelling methods of predictive safety management can be used to confirm impact relations and relevance to safety of newly established safety performance indicators. Newly emerged events at Split Airport related to the medical emergency landings, were observed, and monitored. These events are placed under the category of newly established safety performance indicator SPI26 which is named Number of occurrences related to medical emergency landings. Causal analysis has detected impact relations of newly established safety performance indicator SPI26 – Number of occurrences related to medical emergency landings with six other safety performance indicators, i.e., SPI2 – Number of occurrences related to wrong figures for loadsheet, SPI4 – Number of aircraft damage occurrences, SPI8 – Number of apron maintenance incidents, SPI10 – Number of occurrences related to manoeuvring area maintenance, SPI11 – Number of occurrences related to communication, and SPI23 – Number of engine start-up incidents, proving with it, its relevance to safety.

Table 82 shows dataset of observed and predicted organisational and safety performance indicators at the Split Airport, obtained by using conceptual model of predictive safety management in aviation.

Figure 144 shows graphically events occurring over the observed time period from January 2014 to December 2021 and predicted time period from January 2022 to December 2023, obtained by using conceptual model of predictive safety management in aviation. Figure shows all events and most probable causes of predicted events.

Table 83 shows a layout of proposed mitigation measures based on predictive safety management methodology, on the sample of Split Airport operations. Table includes importance level, anticipated time of occurrence, tolerance interval of anticipated time of occurrence, detected SPI (area of occurrence), name of detected SPI, area of concern, anticipated number of occurrences, proposed mitigation measure/ action (direct), causal factors (OIs & SPIs), area of causal impact and additional proposed mitigation measure/ action.

**Table 82 Dataset of observed and predicted organisational and safety performance indicators at the Split Airport**

Month-Year	OI1	OI2	SPI1	SPI2	SPI3	SPI4	SPI5	SPI6	SPI7	SPI8	SPI9	SPI10	SPI11	SPI12	SPI13	SPI14	SPI15	SPI16	SPI17	SPI18	SPI19	SPI20	SPI21	SPI22	SPI23	SPI24	SPI25
Jan-14	438	24900	0	0	0	0	0	0	0	0	0	0	0	0	0	0	0	0	0	0	0	0	1	0	0	0	0
Feb-14	392	20825	0	0	0	0	0	0	0	0	0	0	0	0	0	0	0	0	1	0	0	1	0	0	0	0	0
Mar-14	514	26410	0	0	0	0	0	0	0	0	0	0	0	0	0	1	0	0	0	0	0	1	1	0	0	1	0
Apr-14	1032	77575	0	0	0	0	0	0	0	2	0	4	1	0	0	0	0	0	0	0	0	0	1	0	0	0	0
May-14	1942	157070	0	0	0	0	0	0	0	1	0	0	0	0	0	0	0	1	0	0	0	0	1	0	0	1	0
Jun-14	2554	234139	0	0	0	0	2	0	0	1	0	0	0	0	1	1	1	0	1	0	0	1	6	0	0	0	0
Jul-14	3872	386039	0	0	1	0	1	0	0	0	0	0	0	0	1	0	5	0	0	0	0	0	1	0	0	10	0
Aug-14	3954	389032	0	0	0	0	0	0	0	0	1	1	0	0	0	0	0	1	0	0	0	0	3	0	1	1	0
Sep-14	2592	240991	0	0	0	1	0	0	0	1	1	0	0	0	0	1	2	0	0	0	0	1	0	0	1	2	0
Oct-14	1470	114161	0	0	0	0	0	0	0	1	0	0	0	0	0	0	0	0	0	0	0	0	1	0	0	2	0
Nov-14	504	27359	0	0	0	0	0	0	0	0	0	0	0	0	0	0	0	0	0	0	0	0	0	0	0	0	0
Dec-14	528	30811	0	0	0	0	0	0	0	0	0	0	0	0	0	0	0	0	0	0	0	0	0	0	0	0	0
Jan-15	504	23513	0	0	0	0	0	0	0	0	0	1	0	0	0	0	0	0	0	0	0	0	0	0	0	0	0
Feb-15	454	22234	0	0	0	0	0	0	0	0	0	0	0	0	0	0	0	0	0	0	0	0	2	0	0	0	0
Mar-15	576	31941	0	0	0	0	0	0	0	0	0	0	0	0	0	1	0	0	0	0	0	0	0	0	0	0	0
Apr-15	1132	73149	0	0	0	0	0	0	0	0	0	0	0	0	1	0	2	0	0	0	0	0	1	0	0	2	0
May-15	2232	179794	0	0	1	0	0	0	0	0	1	0	0	0	0	0	1	0	0	0	0	0	1	0	1	0	0
Jun-15	2942	267755	0	0	0	0	0	0	0	1	0	0	0	0	0	0	1	1	0	0	0	2	1	0	1	1	0
Jul-15	4374	431014	1	0	1	1	1	0	0	0	0	0	0	0	0	1	10	0	0	0	0	1	3	0	0	4	1
Aug-15	4162	427830	0	0	0	0	1	0	0	0	0	0	0	0	0	0	10	0	1	0	0	0	2	0	0	3	0
Sep-15	2826	285446	0	0	0	0	1	0	0	1	0	0	0	0	0	0	6	0	0	0	0	0	1	0	0	0	0
Oct-15	1582	133129	0	0	0	0	0	0	0	1	0	0	0	0	0	0	2	0	0	0	0	0	1	0	0	0	0
Nov-15	640	27938	0	0	0	0	0	0	0	0	1	0	0	0	0	0	0	0	0	0	0	0	0	0	0	0	0
Dec-15	564	27137	0	0	0	0	0	0	0	1	0	0	0	0	0	1	0	0	0	0	0	0	0	0	0	0	0
Jan-16	492	25028	0	0	0	0	0	0	0	0	0	0	0	0	0	0	0	0	0	0	0	0	1	0	0	0	0
Feb-16	494	22782	0	0	0	0	0	0	0	0	1	0	0	0	0	0	0	0	0	0	0	0	3	0	0	1	0
Mar-16	624	33477	1	0	0	0	1	0	1	0	0	0	0	0	0	0	1	0	0	0	0	0	0	0	0	0	0
Apr-16	1142	73764	0	0	0	0	0	0	0	0	0	0	0	0	0	0	1	0	0	0	0	0	1	0	0	0	0
May-16	2390	201906	0	0	1	0	2	0	1	0	0	0	0	0	0	0	6	0	1	0	0	1	2	0	0	2	0
Jun-16	3148	319135	0	0	1	0	0	0	0	0	0	0	0	0	0	0	14	0	0	0	0	2	3	0	0	1	1
Jul-16	4824	540778	0	0	0	0	1	0	0	0	1	0	0	0	0	0	16	0	0	0	0	0	3	0	0	0	0
Aug-16	4518	483215	0	0	0	1	1	0	0	1	0	0	0	0	0	0	15	1	0	0	0	1	3	0	0	0	1
Sep-16	3280	337967	0	0	0	0	1	0	0	1	0	0	1	0	1	0	5	0	0	0	0	3	5	1	0	2	2
Oct-16	1876	165299	0	0	0	0	0	0	0	0	0	0	0	0	0	0	2	0	0	0	0	2	1	0	0	1	0
Nov-16	582	30676	0	0	0	0	0	0	0	0	0	0	0	0	0	0	0	0	0	0	0	0	1	0	0	0	0
Dec-16	570	28779	0	0	0	0	0	0	0	0	0	0	0	0	0	0	2	0	0	0	0	0	0	0	0	0	0
Jan-17	586	28994	0	0	0	1	0	0	0	0	0	1	0	0	0	0	0	1	0	0	0	0	0	0	0	0	0
Feb-17	496	22646	0	0	0	0	0	0	0	0	0	0	0	0	0	0	0	0	0	1	0	0	0	0	0	1	1
Mar-17	640	31878	1	0	0	0	0	0	0	0	0	0	0	0	0	0	0	0	0	0	0	0	0	0	0	1	1
Apr-17	1378	120980	0	0	0	0	0	0	0	0	0	0	0	0	0	0	1	0	0	0	0	0	0	0	0	1	0
May-17	2644	254265	0	0	0	0	1	0	0	0	1	0	0	0	0	0	3	0	0	0	0	0	1	0	0	3	0
Jun-17	3594	401347	0	0	0	0	0	0	0	0	0	0	0	0	0	0	6	0	0	0	0	0	5	1	0	0	1
Jul-17	5216	653743	0	0	0	0	3	0	0	0	0	0	0	0	0	0	7	0	0	0	0	0	0	0	0	2	0
Aug-17	5078	590830	0	0	0	0	0	0	0	1	0	0	0	0	0	0	0	0	0	0	0	0	4	0	0	3	0
Sep-17	378	418836	0	0	0	0	0	0	0	0	0	0	0	0	0	0	1	0	0	0	0	0	0	0	0	4	1
Oct-17	2116	195837	0	0	0	0	0	0	0	0	0	0	0	0	0	0	1	0	0	1	1	0	0	0	0	1	1
Nov-17	654	37343	0	0	0	0	0	0	0	0	0	1	0	0	0	0	0	0	0	0	0	0	0	0	0	0	0
Dec-17	554	34626	0	0	0	0	0	0	0	0	0	0	0	0	0	0	0	0	0	0	0	0	0	0	0	0	0
Jan-18	590	32006	0	0	0	0	0	0	0	0	0	1	0	0	0	0	0	0	0	0	0	0	1	0	0	0	0
Feb-18	520	29109	0	0	0	0	0	0	0	0	0	1	0	0	0	1	0	0	0	2	0	0	0	0	0	1	0
Mar-18	748	51331	0	0	0	0	0	0	0	0	0	1	0	1	0	0	0	0	0	0	0	0	2	0	0	0	0
Apr-18	1486	121372	0	0	0	0	0	0	0	0	0	0	0	0	0	0	1	0	0	0	0	1	1	0	0	2	0
May-18	2878	301377	0	0	0	0	0	0	0	0	0	0	0	0	0	0	5	0	0	0	0	0	1	0	0	0	0
Jun-18	4052	471962	0	0	0	0	0	0	0	0	0	0	0	0	0	0	2	0	0	0	0	0	0	0	0	0	1
Jul-18	5504	691810	0	0	0	0	1	0	0	0	0	0	0	0	0	0	6	0	0	0	0	2	8	0	0	1	0
Aug-18	5136	625209	0	0	0	0	0	0	0	0	0	1	0	0	0	0	5	1	0	0	0	3	0	0	0	3	0
Sep-18	3842	452964	0	0	0	0	0	0	0	0	0	0	0	0	0	0	4	0	1	0	0	0	3	0	0	4	0
Oct-18	2272	223092	0	0	0	0	2	0	0	0	1	0	0	0	0	0	5	0	0	0	0	1	1	1	0	0	0

Nov-18	750	52942	0	0	0	0	0	0	0	0	0	0	0	0	0	0	0	0	0	0	0	0	0	0	0	0
Dec-18	646	42434	0	0	0	0	0	0	0	0	0	0	0	0	0	0	0	0	0	0	0	0	0	0	0	0
Jan-19	664	34694	0	0	0	0	0	0	0	0	0	0	0	0	0	0	0	0	0	0	0	0	0	0	0	0
Feb-19	634	33087	0	0	0	0	0	0	0	0	0	0	0	0	0	0	0	0	0	0	0	0	3	0	0	0
Mar-19	800	48095	0	0	0	0	0	0	0	1	0	0	0	0	1	0	0	0	0	0	0	0	0	0	0	0
Apr-19	1698	153474	0	0	0	0	0	0	0	0	0	0	0	1	0	4	0	0	0	0	0	0	1	0	0	1
May-19	2992	308447	0	0	0	0	1	0	0	0	0	0	0	0	1	0	0	0	0	0	0	0	1	0	0	2
Jun-19	4318	510438	0	0	0	0	0	0	0	0	0	0	0	0	5	0	0	0	0	0	0	1	1	0	0	2
Jul-19	5576	719796	2	0	1	0	1	0	0	0	0	0	0	0	1	0	0	0	0	0	0	0	2	0	0	13
Aug-19	5320	669403	0	0	0	0	0	0	0	1	0	1	0	0	2	2	0	0	0	0	0	1	2	0	0	5
Sep-19	3848	467544	0	0	0	0	0	0	0	0	0	0	0	0	0	0	0	0	0	0	0	1	0	0	0	0
Oct-19	2372	244259	0	0	3	0	0	0	0	0	0	2	0	0	1	0	0	0	0	0	0	0	4	0	0	0
Nov-19	634	42859	0	0	1	0	0	0	0	0	0	0	0	0	2	0	0	0	0	0	0	0	0	0	0	1
Dec-19	574	38949	0	0	0	0	0	0	0	0	0	0	0	0	2	0	0	0	0	0	0	1	0	0	0	0
Jan-20	567	35282	0	0	0	0	0	0	0	0	0	0	0	0	0	0	0	0	0	0	0	0	1	0	0	0
Feb-20	474	24606	0	0	0	0	0	0	0	0	0	0	0	0	0	0	0	0	0	0	0	0	0	0	0	0
Mar-20	370	16117	0	0	0	0	0	0	0	0	0	0	0	0	0	0	0	0	0	0	0	0	0	0	0	0
Apr-20	16	0	0	0	0	0	0	0	0	1	0	0	0	0	0	0	0	0	0	0	0	0	0	0	0	0
May-20	194	2319	0	0	0	0	0	0	0	0	0	0	0	0	0	0	0	0	0	0	0	0	0	0	0	0
Jun-20	818	24929	0	0	0	0	0	0	0	0	0	0	0	0	0	2	0	0	0	0	0	0	0	0	0	1
Jul-20	2757	169229	0	0	0	0	3	0	0	0	0	0	0	0	0	11	1	0	0	0	0	0	1	0	0	6
Aug-20	3676	271362	1	0	0	0	0	0	0	0	0	0	1	0	0	7	0	0	0	0	0	0	0	0	0	0
Sep-20	1807	74653	0	0	0	0	0	0	0	0	0	0	0	0	0	2	0	0	0	0	0	1	0	0	1	0
Oct-20	720	25050	0	0	0	0	0	0	0	0	0	0	0	0	0	1	0	0	0	0	0	0	0	0	0	1
Nov-20	410	7658	0	0	1	0	0	0	0	0	0	0	0	0	0	0	0	0	0	0	0	0	0	0	0	0
Dec-20	341	8145	0	0	0	0	0	0	0	0	0	0	0	0	0	0	0	0	0	0	0	0	0	0	0	0
Jan-21	314	7415	0	0	0	0	0	0	0	0	0	0	0	0	0	0	0	0	0	0	0	0	0	0	0	0
Feb-21	274	5706	0	0	0	0	0	0	0	0	0	0	0	0	0	0	0	0	0	0	0	0	0	0	0	0
Mar-21	358	8031	0	0	0	0	0	0	0	0	0	0	0	0	0	0	0	0	0	0	0	0	0	0	0	0
Apr-21	587	13964	0	0	0	0	0	0	0	0	0	0	0	0	0	0	0	0	0	0	0	0	0	0	0	0
May-21	883	32754	0	0	0	0	0	0	0	0	0	0	0	0	2	0	0	0	0	0	0	0	1	0	0	0
Jun-21	2051	114687	0	0	0	0	1	0	0	0	0	0	0	0	0	2	0	0	0	0	0	0	2	0	0	1
Jul-21	4084	349042	0	1	0	0	0	0	0	2	0	0	0	0	0	0	2	0	0	0	0	0	0	0	0	0
Aug-21	4728	491358	0	0	0	0	0	0	0	0	0	0	0	0	0	0	0	0	0	0	0	0	1	0	0	7
Sep-21	3435	326347	0	0	0	0	0	0	0	0	0	0	0	0	0	1	0	0	0	0	0	1	1	0	0	1
Oct-21	2090	160720	0	0	0	0	1	0	0	0	0	0	0	0	0	0	0	0	0	0	0	0	0	0	0	0
Nov-21	613	25726	0	0	0	0	0	0	0	0	0	0	0	0	0	0	0	0	0	0	0	0	0	0	0	0
Dec-21	615	23428	0	0	0	0	0	0	0	0	0	0	0	0	0	0	0	0	0	0	0	1	0	0	0	0
Jan-22	599	20618	0	0	0	0	0	0	0	0	0	0	0	0	0	0	0	0	0	0	0	0	0	0	0	0
Feb-22	546	16764	0	0	0	0	0	0	0	0	0	0	0	0	0	0	0	0	0	0	0	0	0	0	0	0
Mar-22	658	25049	0	0	0	0	0	0	0	0	0	0	0	0	0	0	0	0	0	0	0	0	0	0	0	0
Apr-22	1138	73424	0	0	0	0	0	0	0	0	0	0	0	0	0	0	0	0	0	0	0	0	0	0	0	1
May-22	2099	173881	0	0	0	0	0	0	0	0	0	0	0	0	0	2	0	0	0	0	0	0	0	0	0	1
Jun-22	3014	287188	0	0	0	0	0	0	0	0	0	0	0	0	1	3	0	0	0	0	0	1	2	0	0	1
Jul-22	4605	486821	0	0	0	0	1	0	0	0	0	0	0	0	0	7	0	0	0	0	0	0	2	0	0	4
Aug-22	4651	487669	0	0	0	0	0	0	0	0	0	0	0	0	0	5	0	0	0	0	0	1	1	0	0	3
Sep-22	2830	319733	0	0	0	0	0	0	0	0	0	0	0	0	0	2	0	0	0	0	0	1	1	0	0	2
Oct-22	1891	151833	0	0	0	0	0	0	0	0	0	0	0	0	0	1	0	0	0	0	0	0	0	0	0	0
Nov-22	678	25702	0	0	0	0	0	0	0	0	0	0	0	0	0	0	0	0	0	0	0	0	0	0	0	0
Dec-22	628	23428	0	0	0	0	0	0	0	0	0	0	0	0	0	0	0	0	0	0	0	0	0	0	0	0
Jan-23	599	20618	0	0	0	0	0	0	0	0	0	0	0	0	0	0	0	0	0	0	0	0	0	0	0	0
Feb-23	546	16764	0	0	0	0	0	0	0	0	0	0	0	0	0	0	0	0	0	0	0	0	0	0	0	0
Mar-23	658	25049	0	0	0	0	0	0	0	0	0	0	0	0	0	0	0	0	0	0	0	0	0	0	0	0
Apr-23	1138	73424	0	0	0	0	0	0	0	0	0	0	0	0	0	0	0	0	0	0	0	0	0	0	0	1
May-23	2099	173881	0	0	0	0	0	0	0	0	0	0	0	0	0	2	0	0	0	0	0	0	0	0	0	1
Jun-23	3014	287188	0	0	0	0	0	0	0	0	0	0	0	0	1	3	0	0	0	0	0	1	2	0	0	1
Jul-23	4605	486821	0	0	0	0	1	0	0	0	0	0	0	0	0	7	0	0	0	0	0	0	2	0	0	4
Aug-23	4651	487669	0	0	0	0	0	0	0	0	0	0	0	0	0	5	0	0	0	0	0	1	1	0	0	3
Sep-23	2830	319733	0	0	0	0	0	0	0	0	0	0	0	0	0	2	0	0	0	0	0	1	1	0	0	2
Oct-23	1891	151833	0	0	0	0	0	0	0	0	0	0	0	0	0	1	0	0	0	0	0	0	0	0	0	0



**Table 83 Proposed mitigation measures to improve safety performance at the Split Airport**

Importance level	Anticipated time of occurrence	Tolerance interval of anticipated time of occurrence	Detected SPI	Name of detected SPI	Area of concern	Anticipated number of occurrences	Proposed mitigation measure/ action (direct)	Causal factors (OIs & SPIs)	Area of causal impact	Proposed mitigation measure/ action (additional)
	April 2022	1-3 months	SPI24	Number of occurrences related to wildlife	Wildlife	1	<ol style="list-style-type: none"> <li>Adjust flight schedules where possible, to minimize the chance of a strike with wildlife species that have predictable pattern of movement.</li> <li>Temporarily close a runway with unusually high bird activity or a large mammal incursion until wildlife control personnel can disperse the animals.</li> <li>Reduces, eliminate, or exclude one or more of elements that attract wildlife, such as food, cover or standing water.</li> <li>Minimize exposed areas that birds can use for perching and nesting.</li> <li>Build a fence or net to prevent wildlife into the airport area.</li> <li>Use repellent and harassment techniques to make the wildlife uncomfortable or fearful.</li> <li>Conduct regular patrols of airside areas to disperse birds and other hazardous wildlife.</li> </ol>	SPI11	Communication	<ol style="list-style-type: none"> <li>Conduct inspection in the communication-related equipment, personnel, and procedures; check whether the procedures are carried out in accordance with the regulations; established findings can reveal omissions and help define specific mitigation measures.</li> <li>Check whether the personnel who carry out procedures is qualified to perform the tasks, and whether all refreshers are carried out on time.</li> <li>Check in particular whether all employees have undergone training in the field of safety and human factors, and whether they are familiar with all safety problems in their field of work.</li> <li>Inspect the technical fitness of communication equipment and systems.</li> <li>Check whether there are language barriers in communication and transfer of information.</li> </ol>
								SPI14	FOD presence	<ol style="list-style-type: none"> <li>Conduct inspection in the area related to FOD presence; check whether the procedures in the area are carried out in accordance with the regulations; established findings can reveal omissions and help define specific mitigation measures.</li> <li>Check whether the personnel who carry out procedures in the area related to FOD presence is qualified to perform the tasks, and whether all refreshers are carried out on time.</li> <li>Check in particular whether all employees have undergone training in the field of safety and human factors, and whether they are familiar with all safety problems in their field of work.</li> <li>Inspect the stand before parking the aircraft to detect FOD presence (FOD check).</li> <li>Inspect manoeuvring surfaces to detect FOD presence (FOD check).</li> </ol>
								OI1	Aircraft operations	ORGANISATIONAL INDICATOR
	May 2022	1-3 months	SPI15	Number of occurrences related to passenger handling at the gate	Passenger handling at the gate	2	<ol style="list-style-type: none"> <li>Conduct inspection related to passenger handling at the gate; check whether the procedures are carried out in accordance with the regulations; established findings can reveal omissions and help define specific mitigation measures.</li> <li>Check whether the personnel who carry out procedures of passenger handling at the gate is qualified to perform the tasks, and whether all refreshers are carried out on time.</li> <li>Check in particular whether all employees have undergone training in the field of safety and human factors, and whether they are familiar with all safety problems in their field of work.</li> <li>Check how passenger security check is conducted at the gate; whether it is carried out efficiently, and in accordance with the regulations.</li> <li>Check the technical fitness of equipment and systems used to handle passengers at the gate.</li> </ol>	SPI17	Training deficiencies	<ol style="list-style-type: none"> <li>Conduct inspection of the personnel training procedures; check whether the procedures are carried out in accordance with the regulations; established findings can reveal omissions and help define specific mitigation measures.</li> <li>Check whether the personnel who carry out training is qualified, and whether training materials are up to date and carried out on time.</li> <li>Check in particular whether all employees have undergone training in the field of safety and human factors, and whether they are familiar with all safety problems related to training deficiencies.</li> </ol>
								SPI21	Ground traffic (GSE) and vehicle driving	<ol style="list-style-type: none"> <li>Conduct inspection in the area of ground traffic (GSE) and vehicle driving; check whether the procedures in this area are carried out in accordance with the regulations; established findings can reveal omissions and help define specific mitigation measures.</li> <li>Check whether the personnel who carry out tasks in the area of ground traffic (GSE) and vehicle driving is qualified to perform the tasks, and whether all refreshers are carried out on time.</li> <li>Check in particular whether all employees have undergone training in the field of safety and human factors, and whether they are familiar with all safety problems in their field of work.</li> <li>Check if the procedures are implemented in correct way, and whether means of transport and equipment are used in correct way.</li> <li>Check whether employees comply with the rules on the maximum permitted driving speed on the operating surface.</li> <li>Check whether there are unnecessary detentions of vehicles and other means and equipment on the service road or at the apron.</li> <li>Check the technical fitness and equipment of all vehicles and other means.</li> </ol>
								SPI23	Engine start-up	<ol style="list-style-type: none"> <li>Conduct inspection related to engine start-up procedures; check whether the procedures are carried out in accordance with the regulations; established findings can reveal omissions and help define specific mitigation measures.</li> <li>Check whether the personnel who carry out procedures is qualified and trained to perform the tasks, and whether all refreshers are carried out on time.</li> <li>Check in particular whether all employees have undergone training in the field of safety and human factors, and whether they are familiar with all safety problems in their field of work.</li> <li>Check whether before engine start-up, an inspection of the aircraft was carried out in order to detect any defects or damage.</li> </ol>

	May 2022	1-3 months	SPI24	Number of occurrences related to wildlife	Wildlife	1	<ol style="list-style-type: none"> <li>Adjust flight schedules where possible, to minimize the chance of a strike with wildlife species that have predictable pattern of movement.</li> <li>Temporarily close a runway with unusually high bird activity or a large mammal incursion until wildlife control personnel can disperse the animals.</li> <li>Reduces, eliminate, or exclude one or more of elements that attract wildlife, such as food, cover or standing water.</li> <li>Minimize exposed areas that birds can use for perching and nesting.</li> <li>Build a fence or net to prevent wildlife into the airport area.</li> <li>Use repellent and harassment techniques to make the wildlife uncomfortable or fearful.</li> <li>Conduct regular patrols of airside areas to disperse birds and other hazardous wildlife.</li> </ol>	SPI11	Communication	<ol style="list-style-type: none"> <li>Conduct inspection in the communication-related equipment, personnel, and procedures; check whether the procedures are carried out in accordance with the regulations; established findings can reveal omissions and help define specific mitigation measures.</li> <li>Check whether the personnel who carry out procedures is qualified to perform the tasks, and whether all refreshers are carried out on time.</li> <li>Check in particular whether all employees have undergone training in the field of safety and human factors, and whether they are familiar with all safety problems in their field of work.</li> <li>Inspect the technical fitness of communication equipment and systems.</li> <li>Check whether there are language barriers in communication and transfer of information.</li> </ol>
								SPI14	FOD presence	<ol style="list-style-type: none"> <li>Conduct inspection in the area related to FOD presence; check whether the procedures in the area are carried out in accordance with the regulations; established findings can reveal omissions and help define specific mitigation measures.</li> <li>Check whether the personnel who carry out procedures in the area related to FOD presence is qualified to perform the tasks, and whether all refreshers are carried out on time.</li> <li>Check in particular whether all employees have undergone training in the field of safety and human factors, and whether they are familiar with all safety problems in their field of work.</li> <li>Inspect the stand before parking the aircraft to detect FOD presence (FOD check).</li> <li>Inspect manoeuvring surfaces to detect FOD presence (FOD check).</li> </ol>
								O11	Aircraft operations	ORGANISATIONAL INDICATOR
	June 2022	1-3 months	SPI14	Number of occurrences related to FOD presence	FOD presence	1	<ol style="list-style-type: none"> <li>Conduct inspection in the area related to FOD presence; check whether the procedures in the area are carried out in accordance with the regulations; established findings can reveal omissions and help define specific mitigation measures.</li> <li>Check whether the personnel who carry out procedures in the area related to FOD presence is qualified to perform the tasks, and whether all refreshers are carried out on time.</li> <li>Check in particular whether all employees have undergone training in the field of safety and human factors, and whether they are familiar with all safety problems in their field of work.</li> <li>Inspect the stand before parking the aircraft to detect FOD presence (FOD check).</li> <li>Inspect manoeuvring surfaces to detect FOD presence (FOD check).</li> </ol>	SPI3	Dangerous goods	<ol style="list-style-type: none"> <li>Conduct inspection in the area of handling dangerous goods; check whether the procedures are carried out in accordance with the regulations regarding dangerous goods (DGR); established findings can reveal omissions and help define specific mitigation measures.</li> <li>Check whether the personnel who carry out handling dangerous goods is qualified to perform the tasks, and whether all refreshers are carried out on time.</li> <li>Check in particular whether all employees have undergone training in the field of safety and human factors, and whether they are familiar with all safety problems in their field of work.</li> </ol>
								SPI11	Communication	<ol style="list-style-type: none"> <li>Conduct inspection in the communication-related equipment, personnel, and procedures; check whether the procedures are carried out in accordance with the regulations; established findings can reveal omissions and help define specific mitigation measures.</li> <li>Check whether the personnel who carry out procedures is qualified to perform the tasks, and whether all refreshers are carried out on time.</li> <li>Check in particular whether all employees have undergone training in the field of safety and human factors, and whether they are familiar with all safety problems in their field of work.</li> <li>Inspect the technical fitness of communication equipment and systems.</li> <li>Check whether there are language barriers in communication and transfer of information.</li> </ol>
								SPI13	Aircraft marshalling	<ol style="list-style-type: none"> <li>Conduct inspection related to aircraft marshalling procedures; check whether the procedures are carried out in accordance with the regulations; established findings can reveal omissions and help define specific mitigation measures.</li> <li>Check whether the personnel who carry out procedures related to aircraft marshalling is qualified to perform the tasks, and whether all refreshers are carried out on time.</li> <li>Check in particular whether all employees have undergone training in the field of safety and human factors, and whether they are familiar with all safety problems in their field of work.</li> </ol>
	June 2022	1-3 months	SPI15	Number of occurrences related to passenger handling at the gate	Passenger handling at the gate	3	<ol style="list-style-type: none"> <li>Conduct inspection related to passenger handling at the gate; check whether the procedures are carried out in accordance with the regulations; established findings can reveal omissions and help define specific mitigation measures.</li> <li>Check whether the personnel who carry out procedures of passenger handling at the gate is qualified to perform the tasks, and whether all refreshers are carried out on time.</li> <li>Check in particular whether all employees have undergone training in the field of safety and human factors, and whether they are familiar with all safety problems in their field of work.</li> <li>Check how passenger security check is conducted at the gate; whether it is carried out efficiently, and in accordance with the regulations.</li> <li>Check the technical fitness of equipment and systems used to handle passengers at the gate.</li> </ol>	SPI7	Training deficiencies	<ol style="list-style-type: none"> <li>Conduct inspection of the personnel training procedures; check whether the procedures are carried out in accordance with the regulations; established findings can reveal omissions and help define specific mitigation measures.</li> <li>Check whether the personnel who carry out training is qualified, and whether training materials are up to date and carried out on time.</li> <li>Check in particular whether all employees have undergone training in the field of safety and human factors, and whether they are familiar with all safety problems related to training deficiencies.</li> </ol>
								SPI21	Ground traffic (GSE) and vehicle driving	<ol style="list-style-type: none"> <li>Conduct inspection in the area of ground traffic (GSE) and vehicle driving; check whether the procedures in this area are carried out in accordance with the regulations; established findings can reveal omissions and help define specific mitigation measures.</li> <li>Check whether the personnel who carry out tasks in the area of ground traffic (GSE) and vehicle driving is qualified to perform the tasks, and whether all refreshers are carried out on time.</li> <li>Check in particular whether all employees have undergone training in the field of safety and human factors, and whether they are familiar with all safety problems in their field of work.</li> <li>Check if the procedures are implemented in correct way, and whether means of transport and equipment are used in correct way.</li> <li>Check whether employees comply with the rules on the maximum permitted driving speed on the operating surface.</li> <li>Check whether there are unnecessary detentions of vehicles and other means and equipment on the service road or at the apron.</li> <li>Check the technical fitness and equipment of all vehicles and other means.</li> </ol>



	June 2022	1-3 months	SPI20	Number of occurrences related to baggage loading/unloading	Baggage loading/unloading	1	<ol style="list-style-type: none"> <li>1. Conduct inspection of the procedures related to baggage loading/unloading; check whether the procedures are carried out in accordance with the regulations; established findings can reveal omissions and help define specific mitigation measures.</li> <li>2. Check whether the personnel who carry out baggage loading/unloading is qualified, and refreshers are carried out on time.</li> <li>3. Check in particular whether all employees have undergone training in the field of safety and human factors, and whether they are familiar with all safety problems related to their field of work.</li> <li>4. Check if the equipment and systems used for baggage loading/unloading are correct and correctly used.</li> </ol>	SPI23	Engine start-up	<ol style="list-style-type: none"> <li>1. Conduct inspection related to engine start-up procedures; check whether the procedures are carried out in accordance with the regulations; established findings can reveal omissions and help define specific mitigation measures.</li> <li>2. Check whether the personnel who carry out procedures is qualified and trained to perform the tasks, and whether all refreshers are carried out on time.</li> <li>3. Check in particular whether all employees have undergone training in the field of safety and human factors, and whether they are familiar with all safety problems in their field of work.</li> <li>4. Check whether before engine start-up, an inspection of the aircraft was carried out in order to detect any defects or damage.</li> </ol>
								SPI17	Training deficiencies	<ol style="list-style-type: none"> <li>1. Conduct inspection of the personnel training procedures; check whether the procedures are carried out in accordance with the regulations; established findings can reveal omissions and help define specific mitigation measures.</li> <li>2. Check whether the personnel who carry out training is qualified, and whether training materials are up to date and carried out on time.</li> <li>3. Check in particular whether all employees have undergone training in the field of safety and human factors, and whether they are familiar with all safety problems related to training deficiencies.</li> </ol>
								SPI21	Ground traffic (GSE) and vehicle driving	<ol style="list-style-type: none"> <li>1. Conduct inspection in the area of ground traffic (GSE) and vehicle driving; check whether the procedures in this area are carried out in accordance with the regulations; established findings can reveal omissions and help define specific mitigation measures.</li> <li>2. Check whether the personnel who carry out tasks in the area of ground traffic (GSE) and vehicle driving is qualified to perform the tasks, and whether all refreshers are carried out on time.</li> <li>3. Check in particular whether all employees have undergone training in the field of safety and human factors, and whether they are familiar with all safety problems in their field of work.</li> <li>4. Check if the procedures are implemented in correct way, and whether means of transport and equipment are used in correct way.</li> <li>5. Check whether employees comply with the rules on the maximum permitted driving speed on the operating surface.</li> <li>6. Check whether there are unnecessary detentions of vehicles and other means and equipment on the service road or at the apron.</li> <li>7. Check the technical fitness and equipment of all vehicles and other means.</li> </ol>
								OI2	Passengers	ORGANISATIONAL INDICATOR
	June 2022	1-3 months	SPI21	Number of occurrences related to ground traffic (GSE) and vehicle driving	Ground traffic (GSE) and vehicle driving	2	<ol style="list-style-type: none"> <li>1. Conduct inspection in the area of ground traffic (GSE) and vehicle driving; check whether the procedures in this area are carried out in accordance with the regulations; established findings can reveal omissions and help define specific mitigation measures.</li> <li>2. Check whether the personnel who carry out tasks in the area of ground traffic (GSE) and vehicle driving is qualified to perform the tasks, and whether all refreshers are carried out on time.</li> <li>3. Check in particular whether all employees have undergone training in the field of safety and human factors, and whether they are familiar with all safety problems in their field of work.</li> <li>4. Check if the procedures are implemented in correct way, and whether means of transport and equipment are used in correct way.</li> <li>5. Check whether employees comply with the rules on the maximum permitted driving speed on the operating surface.</li> <li>6. Check whether there are unnecessary detentions of vehicles and other means and equipment on the service road or at the apron.</li> <li>7. Check the technical fitness and equipment of all vehicles and other means.</li> </ol>	SPI11	LIRF and loadsheet crosscheck	<ol style="list-style-type: none"> <li>1. Conduct inspection in the area of LIRF and loadsheet crosscheck; check whether the procedures are carried out in accordance with the regulations; established findings can reveal omissions and help define specific mitigation measures.</li> <li>2. Check whether the personnel who carry out LIRF and loadsheet crosscheck is qualified to perform the tasks, and whether all refreshers are carried out on time.</li> <li>3. Check in particular whether all employees have undergone training in the field of safety and human factors, and whether they are familiar with all safety problems in their field of work.</li> <li>4. Check the accuracy of all data on the loadsheet, i.e., destination, flight number, registration, aircraft type, crew and flight date, and whether it is correctly signed by the responsible persons.</li> <li>5. Check the accuracy of entered operating weights and the weight of passengers and baggage.</li> <li>6. Check the correctness of other documentation according to prescribed requirements.</li> </ol>
								SPI10	Manoeuvring area maintenance	<ol style="list-style-type: none"> <li>1. Conduct inspection in the manoeuvring area maintenance; check whether the procedures in the manoeuvring area maintenance are carried out in accordance with the regulations; established findings can reveal omissions and help define specific mitigation measures.</li> <li>2. Check whether the personnel who carry out procedures in the manoeuvring area maintenance is qualified to perform the tasks, and whether all refreshers are carried out on time.</li> <li>3. Check in particular whether all employees have undergone training in the field of safety and human factors, and whether they are familiar with all safety problems in their field of work.</li> <li>4. Check whether there is major damage to the pavement of the manoeuvring area.</li> <li>5. Check whether there are one or more foreign objects on the pavement of the manoeuvring area that may endanger the safety of the aircraft (FOD).</li> <li>6. Check whether there are greasy stains from lubricants, motor oil, fuel or the like on the pavement of the manoeuvring area.</li> <li>7. Check the correctness of horizontal and vertical signalisation on the manoeuvring area.</li> <li>8. Check whether all vehicles, means and equipment are placed in their designated places.</li> </ol>
								OI1	Aircraft operations	ORGANISATIONAL INDICATOR

	June 2022	1-3 months	SPI24	Number of occurrences related to wildlife	Wildlife	1	<ol style="list-style-type: none"> <li>1. Adjust flight schedules where possible, to minimize the chance of a strike with wildlife species that have predictable pattern of movement.</li> <li>2. Temporarily close a runway with unusually high bird activity or a large mammal incursion until wildlife control personnel can disperse the animals.</li> <li>3. Reduces, eliminate, or exclude one or more of elements that attract wildlife, such as food, cover or standing water.</li> <li>4. Minimize exposed areas that birds can use for perching and nesting.</li> <li>5. Build a fence or net to prevent wildlife into the airport area.</li> <li>6. Use repellent and harassment techniques to make the wildlife uncomfortable or fearful.</li> <li>7. Conduct regular patrols of airside areas to disperse birds and other hazardous wildlife.</li> </ol>	SPI11	Communication	<ol style="list-style-type: none"> <li>1. Conduct inspection in the communication-related equipment, personnel, and procedures; check whether the procedures are carried out in accordance with the regulations; established findings can reveal omissions and help define specific mitigation measures.</li> <li>2. Check whether the personnel who carry out procedures is qualified to perform the tasks, and whether all refreshers are carried out on time.</li> <li>3. Check in particular whether all employees have undergone training in the field of safety and human factors, and whether they are familiar with all safety problems in their field of work.</li> <li>4. Inspect the technical fitness of communication equipment and systems.</li> <li>5. Check whether there are language barriers in communication and transfer of information.</li> </ol>
	July 2022	1-3 months	SPI5	Number of personnel or passenger injuries	Personnel or passenger injuries	1	<ol style="list-style-type: none"> <li>1. Check information and guidance system for passengers, to prevent them from getting lost or injured.</li> <li>2. Check if the markings and signs are visible and correctly installed on all areas where passengers are not allowed to enter, i.e., secure, or restricted areas, to prevent them from getting lost or injured.</li> </ol>	O11	Aircraft operations	<p style="text-align: center;">ORGANISATIONAL INDICATOR</p>
								SPI10	Manoeuvring area maintenance	<ol style="list-style-type: none"> <li>1. Conduct inspection in the manoeuvring area maintenance; check whether the procedures in the manoeuvring area maintenance are carried out in accordance with the regulations; established findings can reveal omissions and help define specific mitigation measures.</li> <li>2. Check whether the personnel who carry out procedures in the manoeuvring area maintenance is qualified to perform the tasks, and whether all refreshers are carried out on time.</li> <li>3. Check in particular whether all employees have undergone training in the field of safety and human factors, and whether they are familiar with all safety problems in their field of work.</li> <li>4. Check whether there is major damage to the pavement of the manoeuvring area.</li> <li>5. Check whether there are one or more foreign objects on the pavement of the manoeuvring area that may endanger the safety of the aircraft (FOD).</li> <li>6. Check whether there are greasy stains from lubricants, motor oil, fuel, or the like on the pavement of the manoeuvring area.</li> <li>7. Check the correctness of horizontal and vertical signalisation on the manoeuvring area.</li> <li>8. Check whether all vehicles, means and equipment are placed in their designated places.</li> </ol>
								SPI15	Passenger handling at the gate	<ol style="list-style-type: none"> <li>1. Conduct inspection related to passenger handling at the gate; check whether the procedures are carried out in accordance with the regulations; established findings can reveal omissions and help define specific mitigation measures.</li> <li>2. Check whether the personnel who carry out procedures of passenger handling at the gate is qualified to perform the tasks, and whether all refreshers are carried out on time.</li> <li>3. Check in particular whether all employees have undergone training in the field of safety and human factors, and whether they are familiar with all safety problems in their field of work.</li> <li>4. Check how passenger security check is conducted at the gate; whether it is carried out efficiently, and in accordance with the regulations.</li> <li>5. Check the technical fitness of equipment and systems used to handle passengers at the gate.</li> </ol>
								SPI21	Ground traffic (GSE) and vehicle driving	<ol style="list-style-type: none"> <li>1. Conduct inspection in the area of ground traffic (GSE) and vehicle driving; check whether the procedures in this area are carried out in accordance with the regulations; established findings can reveal omissions and help define specific mitigation measures.</li> <li>2. Check whether the personnel who carry out tasks in the area of ground traffic (GSE) and vehicle driving is qualified to perform the tasks, and whether all refreshers are carried out on time.</li> <li>3. Check in particular whether all employees have undergone training in the field of safety and human factors, and whether they are familiar with all safety problems in their field of work.</li> <li>4. Check if the procedures are implemented in correct way, and whether means of transport and equipment are used in correct way.</li> <li>5. Check whether employees comply with the rules on the maximum permitted driving speed on the operating surface.</li> <li>6. Check whether there are unnecessary detentions of vehicles and other means and equipment on the service road or at the apron.</li> <li>7. Check the technical fitness and equipment of all vehicles and other means.</li> </ol>

	July 2022	1-3 months	SPI15	Number of occurrences related to passenger handling at the gate	Passenger handling at the gate	7  1. Conduct inspection related to passenger handling at the gate; check whether the procedures are carried out in accordance with the regulations; established findings can reveal omissions and help define specific mitigation measures. 2. Check whether the personnel who carry out procedures of passenger handling at the gate is qualified to perform the tasks, and whether all refreshers are carried out on time. 3. Check in particular whether all employees have undergone training in the field of safety and human factors, and whether they are familiar with all safety problems in their field of work. 4. Check how passenger security check is conducted at the gate; whether it is carried out efficiently, and in accordance with the regulations. 5. Check the technical fitness of equipment and systems used to handle passengers at the gate.	SPI7	Training deficiencies	1. Conduct inspection of the personnel training procedures; check whether the procedures are carried out in accordance with the regulations; established findings can reveal omissions and help define specific mitigation measures. 2. Check whether the personnel who carry out training is qualified, and whether training materials are up to date and carried out on time. 3. Check in particular whether all employees have undergone training in the field of safety and human factors, and whether they are familiar with all safety problems related to training deficiencies.
	July 2022	1-3 months	SPI21	Number of occurrences related to ground traffic (GSE) and vehicle driving	Ground traffic (GSE) and vehicle driving	2  1. Conduct inspection in the area of ground traffic (GSE) and vehicle driving; check whether the procedures in this area are carried out in accordance with the regulations; established findings can reveal omissions and help define specific mitigation measures. 2. Check whether the personnel who carry out tasks in the area of ground traffic (GSE) and vehicle driving is qualified to perform the tasks, and whether all refreshers are carried out on time. 3. Check in particular whether all employees have undergone training in the field of safety and human factors, and whether they are familiar with all safety problems in their field of work. 4. Check if the procedures are implemented in correct way, and whether means of transport and equipment are used in correct way. 5. Check whether employees comply with the rules on the maximum permitted driving speed on the operating surface. 6. Check whether there are unnecessary detentions of vehicles and other means and equipment on the service road or at the apron. 7. Check the technical fitness and equipment of all vehicles and other means.	SPI11	LIRF and loadsheet crosscheck	1. Conduct inspection in the area of LIRF and loadsheet crosscheck; check whether the procedures are carried out in accordance with the regulations; established findings can reveal omissions and help define specific mitigation measures. 2. Check whether the personnel who carry out LIRF and loadsheet crosscheck is qualified to perform the tasks, and whether all refreshers are carried out on time. 3. Check in particular whether all employees have undergone training in the field of safety and human factors, and whether they are familiar with all safety problems in their field of work. 4. Check the accuracy of all data on the loadsheet, i.e., destination, flight number, registration, aircraft type, crew and flight date, and whether it is correctly signed by the responsible persons. 5. Check the accuracy of entered operating weights and the weight of passengers and baggage. 6. Check the correctness of other documentation according to prescribed requirements.
	July 2022	1-3 months	SPI24	Number of occurrences related to wildlife	Wildlife	4  1. Adjust flight schedules where possible, to minimize the chance of a strike with wildlife species that have predictable pattern of movement. 2. Temporarily close a runway with unusually high bird activity or a large mammal incursion until wildlife control personnel can disperse the animals. 3. Reduces, eliminate, or exclude one or more of elements that attract wildlife, such as food, cover or standing water. 4. Minimize exposed areas that birds can use for perching and nesting. 5. Build a fence or net to prevent wildlife into the airport area. 6. Use repellent and harassment techniques to make the wildlife	SPI11	Communication	1. Conduct inspection in the communication-related equipment, personnel, and procedures; check whether the procedures are carried out in accordance with the regulations; established findings can reveal omissions and help define specific mitigation measures. 2. Check whether the personnel who carry out procedures is qualified to perform the tasks, and whether all refreshers are carried out on time. 3. Check in particular whether all employees have undergone training in the field of safety and human factors, and whether they are familiar with all safety problems in their field of work. 4. Inspect the technical fitness of communication equipment and systems. 5. Check whether there are language barriers in communication and transfer of information.
							OI1	Aircraft operations	ORGANISATIONAL INDICATOR

					uncomfortable or fearful. 7. Conduct regular patrols of airside areas to disperse birds and other hazardous wildlife.	SPI14	FOD presence	<ol style="list-style-type: none"> <li>1. Conduct inspection in the area related to FOD presence; check whether the procedures in the area are carried out in accordance with the regulations; established findings can reveal omissions and help define specific mitigation measures.</li> <li>2. Check whether the personnel who carry out procedures in the area related to FOD presence is qualified to perform the tasks, and whether all refreshers are carried out on time.</li> <li>3. Check in particular whether all employees have undergone training in the field of safety and human factors, and whether they are familiar with all safety problems in their field of work.</li> <li>4. Inspect the stand before parking the aircraft to detect FOD presence (FOD check).</li> <li>5. Inspect manoeuvring surfaces to detect FOD presence (FOD check).</li> </ol>		
						O11	Aircraft operations	ORGANISATIONAL INDICATOR		
	August 2022	4-6 months	SPI15	Number of occurrences related to passenger handling at the gate	Passenger handling at the gate	5	<ol style="list-style-type: none"> <li>1. Conduct inspection related to passenger handling at the gate; check whether the procedures are carried out in accordance with the regulations; established findings can reveal omissions and help define specific mitigation measures.</li> <li>2. Check whether the personnel who carry out procedures of passenger handling at the gate is qualified to perform the tasks, and whether all refreshers are carried out on time.</li> <li>3. Check in particular whether all employees have undergone training in the field of safety and human factors, and whether they are familiar with all safety problems in their field of work.</li> <li>4. Check how passenger security check is conducted at the gate; whether it is carried out efficiently, and in accordance with the regulations.</li> <li>5. Check the technical fitness of equipment and systems used to handle passengers at the gate.</li> </ol>	SPI17	Training deficiencies	<ol style="list-style-type: none"> <li>1. Conduct inspection of the personnel training procedures; check whether the procedures are carried out in accordance with the regulations; established findings can reveal omissions and help define specific mitigation measures.</li> <li>2. Check whether the personnel who carry out training is qualified, and whether training materials are up to date and carried out on time.</li> <li>3. Check in particular whether all employees have undergone training in the field of safety and human factors, and whether they are familiar with all safety problems related to training deficiencies.</li> </ol>
								SPI21	Ground traffic (GSE) and vehicle driving	<ol style="list-style-type: none"> <li>1. Conduct inspection in the area of ground traffic (GSE) and vehicle driving; check whether the procedures in this area are carried out in accordance with the regulations; established findings can reveal omissions and help define specific mitigation measures.</li> <li>2. Check whether the personnel who carry out tasks in the area of ground traffic (GSE) and vehicle driving is qualified to perform the tasks, and whether all refreshers are carried out on time.</li> <li>3. Check in particular whether all employees have undergone training in the field of safety and human factors, and whether they are familiar with all safety problems in their field of work.</li> <li>4. Check if the procedures are implemented in correct way, and whether means of transport and equipment are used in correct way.</li> <li>5. Check whether employees comply with the rules on the maximum permitted driving speed on the operating surface.</li> <li>6. Check whether there are unnecessary detentions of vehicles and other means and equipment on the service road or at the apron.</li> <li>7. Check the technical fitness and equipment of all vehicles and other means.</li> </ol>
								SPI23	Engine start-up	<ol style="list-style-type: none"> <li>1. Conduct inspection related to engine start-up procedures; check whether the procedures are carried out in accordance with the regulations; established findings can reveal omissions and help define specific mitigation measures.</li> <li>2. Check whether the personnel who carry out procedures is qualified and trained to perform the tasks, and whether all refreshers are carried out on time.</li> <li>3. Check in particular whether all employees have undergone training in the field of safety and human factors, and whether they are familiar with all safety problems in their field of work.</li> <li>4. Check whether before engine start-up, an inspection of the aircraft was carried out in order to detect any defects or damage.</li> </ol>
	August 2022	4-6 months	SPI20	Number of occurrences related to baggage loading/unloading	Baggage loading/unloading	1	<ol style="list-style-type: none"> <li>1. Conduct inspection of the procedures related to baggage loading/unloading; check whether the procedures are carried out in accordance with the regulations; established findings can reveal omissions and help define specific mitigation measures.</li> <li>2. Check whether the personnel who carry out baggage loading/unloading is qualified, and refreshers are carried out on time.</li> <li>3. Check in particular whether all employees have undergone training in the field of safety and human factors, and whether they are familiar with all safety problems related to their field of work.</li> <li>4. Check if the equipment and systems used for baggage loading/unloading are correct and correctly used.</li> </ol>	SPI17	Training deficiencies	<ol style="list-style-type: none"> <li>1. Conduct inspection of the personnel training procedures; check whether the procedures are carried out in accordance with the regulations; established findings can reveal omissions and help define specific mitigation measures.</li> <li>2. Check whether the personnel who carry out training is qualified, and whether training materials are up to date and carried out on time.</li> <li>3. Check in particular whether all employees have undergone training in the field of safety and human factors, and whether they are familiar with all safety problems related to training deficiencies.</li> </ol>
								SPI21	Ground traffic (GSE) and vehicle driving	<ol style="list-style-type: none"> <li>1. Conduct inspection in the area of ground traffic (GSE) and vehicle driving; check whether the procedures in this area are carried out in accordance with the regulations; established findings can reveal omissions and help define specific mitigation measures.</li> <li>2. Check whether the personnel who carry out tasks in the area of ground traffic (GSE) and vehicle driving is qualified to perform the tasks, and whether all refreshers are carried out on time.</li> <li>3. Check in particular whether all employees have undergone training in the field of safety and human factors, and whether they are familiar with all safety problems in their field of work.</li> <li>4. Check if the procedures are implemented in correct way, and whether means of transport and equipment are used in correct way.</li> <li>5. Check whether employees comply with the rules on the maximum permitted driving speed on the operating surface.</li> <li>6. Check whether there are unnecessary detentions of vehicles and other means and equipment on the service road or at the apron.</li> <li>7. Check the technical fitness and equipment of all vehicles and other means.</li> </ol>
								O12	Passengers	ORGANISATIONAL INDICATOR

	August 2022	4-6 months	SPI21	Number of occurrences related to ground traffic (GSE) and vehicle driving	Ground traffic (GSE) and vehicle driving	1  1. Conduct inspection in the area of ground traffic (GSE) and vehicle driving; check whether the procedures in this area are carried out in accordance with the regulations; established findings can reveal omissions and help define specific mitigation measures. 2. Check whether the personnel who carry out tasks in the area of ground traffic (GSE) and vehicle driving is qualified to perform the tasks, and whether all refreshers are carried out on time. 3. Check in particular whether all employees have undergone training in the field of safety and human factors, and whether they are familiar with all safety problems in their field of work. 4. Check if the procedures are implemented in correct way, and whether means of transport and equipment are used in correct way. 5. Check whether employees comply with the rules on the maximum permitted driving speed on the operating surface. 6. Check whether there are unnecessary detentions of vehicles and other means and equipment on the service road or at the apron. 7. Check the technical fitness and equipment of all vehicles and other means.	SPI11	LIRF and loadsheet crosscheck	1. Conduct inspection in the area of LIRF and loadsheet crosscheck; check whether the procedures are carried out in accordance with the regulations; established findings can reveal omissions and help define specific mitigation measures. 2. Check whether the personnel who carry out LIRF and loadsheet crosscheck is qualified to perform the tasks, and whether all refreshers are carried out on time. 3. Check in particular whether all employees have undergone training in the field of safety and human factors, and whether they are familiar with all safety problems in their field of work. 4. Check the accuracy of all data on the loadsheet, i.e., destination, flight number, registration, aircraft type, crew and flight date, and whether it is correctly signed by the responsible persons.  5. Check the accuracy of entered operating weights and the weight of passengers and baggage. 6. Check the correctness of other documentation according to prescribed requirements.
	August 2022	4-6 months	SPI24	Number of occurrences related to wildlife	Wildlife	3  1. Adjust flight schedules where possible, to minimize the chance of a strike with wildlife species that have predictable pattern of movement. 2. Temporarily close a runway with unusually high bird activity or a large mammal incursion until wildlife control personnel can disperse the animals. 3. Reduces, eliminate, or exclude one or more of elements that attract wildlife, such as food, cover or standing water. 4. Minimize exposed areas that birds can use for perching and nesting. 5. Build a fence or net to prevent wildlife into the airport area. 6. Use repellent and harassment techniques to make the wildlife uncomfortable or fearful. 7. Conduct regular patrols of airside areas to disperse birds and other hazardous wildlife.	SPI11	Communication	1. Conduct inspection in the communication-related equipment, personnel, and procedures; check whether the procedures are carried out in accordance with the regulations; established findings can reveal omissions and help define specific mitigation measures. 2. Check whether the personnel who carry out procedures is qualified to perform the tasks, and whether all refreshers are carried out on time. 3. Check in particular whether all employees have undergone training in the field of safety and human factors, and whether they are familiar with all safety problems in their field of work. 4. Inspect the technical fitness of communication equipment and systems. 5. Check whether there are language barriers in communication and transfer of information.
	September 2022	4-6 months	SPI15	Number of occurrences related to passenger handling at the gate	Passenger handling at the gate	2  1. Conduct inspection related to passenger handling at the gate; check whether the procedures are carried out in accordance with the regulations; established findings can reveal omissions and help define specific mitigation measures. 2. Check whether the personnel who carry out procedures of passenger handling at the gate is qualified to perform the tasks, and whether all refreshers are carried out on time. 3. Check in particular whether all employees have undergone training in the field of safety and human factors, and whether they are familiar with all safety problems in their field of work. 4. Check how passenger security check is conducted at the gate; whether it is carried out efficiently, and in accordance with the regulations.	SPI14	FOD presence	1. Conduct inspection in the area related to FOD presence; check whether the procedures in the area are carried out in accordance with the regulations; established findings can reveal omissions and help define specific mitigation measures. 2. Check whether the personnel who carry out procedures in the area related to FOD presence is qualified to perform the tasks, and whether all refreshers are carried out on time. 3. Check in particular whether all employees have undergone training in the field of safety and human factors, and whether they are familiar with all safety problems in their field of work. 4. Inspect the stand before parking the aircraft to detect FOD presence (FOD check). 5. Inspect manoeuvring surfaces to detect FOD presence (FOD check).
							OI1	Aircraft operations	ORGANISATIONAL INDICATOR
							SPI7	Training deficiencies	1. Conduct inspection of the personnel training procedures; check whether the procedures are carried out in accordance with the regulations; established findings can reveal omissions and help define specific mitigation measures. 2. Check whether the personnel who carry out training is qualified, and whether training materials are up to date and carried out on time. 3. Check in particular whether all employees have undergone training in the field of safety and human factors, and whether they are familiar with all safety problems related to training deficiencies.
							SPI21	Ground traffic (GSE) and vehicle driving	1. Conduct inspection in the area of ground traffic (GSE) and vehicle driving; check whether the procedures in this area are carried out in accordance with the regulations; established findings can reveal omissions and help define specific mitigation measures. 2. Check whether the personnel who carry out tasks in the area of ground traffic (GSE) and vehicle driving is qualified to perform the tasks, and whether all refreshers are carried out on time. 3. Check in particular whether all employees have undergone training in the field of safety and human factors, and whether they are familiar with all safety problems in their field of work.

					<p>5. Check the technical fitness of equipment and systems used to handle passengers at the gate.</p>			<p>4. Check if the procedures are implemented in correct way, and whether means of transport and equipment are used in correct way.</p> <p>5. Check whether employees comply with the rules on the maximum permitted driving speed on the operating surface.</p> <p>6. Check whether there are unnecessary detentions of vehicles and other means and equipment on the service road or at the apron.</p> <p>7. Check the technical fitness and equipment of all vehicles and other means.</p>
	September 2022	4-6 months	SPI20	Number of occurrences related to baggage loading/unloading	<p>1</p> <p>Baggage loading/unloading</p> <p>1. Conduct inspection of the procedures related to baggage loading/unloading; check whether the procedures are carried out in accordance with the regulations; established findings can reveal omissions and help define specific mitigation measures.</p> <p>2. Check whether the personnel who carry out baggage loading/unloading is qualified, and refreshers are carried out on time.</p> <p>3. Check in particular whether all employees have undergone training in the field of safety and human factors, and whether they are familiar with all safety problems related to their field of work.</p> <p>4. Check if the equipment and systems used for baggage loading/unloading are correct and correctly used.</p>	SPI23	Engine start-up	<p>1. Conduct inspection related to engine start-up procedures; check whether the procedures are carried out in accordance with the regulations; established findings can reveal omissions and help define specific mitigation measures.</p> <p>2. Check whether the personnel who carry out procedures is qualified and trained to perform the tasks, and whether all refreshers are carried out on time.</p> <p>3. Check in particular whether all employees have undergone training in the field of safety and human factors, and whether they are familiar with all safety problems in their field of work.</p> <p>4. Check whether before engine start-up, an inspection of the aircraft was carried out in order to detect any defects or damage.</p>
	September 2022	4-6 months	SPI21	Number of occurrences related to ground traffic (GSE) and vehicle driving	<p>1</p> <p>Ground traffic (GSE) and vehicle driving</p> <p>1. Conduct inspection in the area of ground traffic (GSE) and vehicle driving; check whether the procedures in this area are carried out in accordance with the regulations; established findings can reveal omissions and help define specific mitigation measures.</p> <p>2. Check whether the personnel who carry out tasks in the area of ground traffic (GSE) and vehicle driving is qualified to perform the tasks, and whether all refreshers are carried out on time.</p> <p>3. Check in particular whether all employees have undergone training in the field of safety and human factors, and whether they are familiar with all safety problems in their field of work.</p> <p>4. Check if the procedures are implemented in correct way, and whether means of transport and equipment are used in correct way.</p> <p>5. Check whether employees comply with the rules on the maximum permitted driving speed on the operating surface.</p> <p>6. Check whether there are unnecessary detentions of vehicles and other means and equipment on the service road or at the apron.</p> <p>7. Check the technical fitness and equipment of all vehicles and other means.</p>	SPI17	Training deficiencies	<p>1. Conduct inspection of the personnel training procedures; check whether the procedures are carried out in accordance with the regulations; established findings can reveal omissions and help define specific mitigation measures.</p> <p>2. Check whether the personnel who carry out training is qualified, and whether training materials are up to date and carried out on time.</p> <p>3. Check in particular whether all employees have undergone training in the field of safety and human factors, and whether they are familiar with all safety problems related to training deficiencies.</p>
						SPI21	Ground traffic (GSE) and vehicle driving	<p>1. Conduct inspection in the area of ground traffic (GSE) and vehicle driving; check whether the procedures in this area are carried out in accordance with the regulations; established findings can reveal omissions and help define specific mitigation measures.</p> <p>2. Check whether the personnel who carry out tasks in the area of ground traffic (GSE) and vehicle driving is qualified to perform the tasks, and whether all refreshers are carried out on time.</p> <p>3. Check in particular whether all employees have undergone training in the field of safety and human factors, and whether they are familiar with all safety problems in their field of work.</p> <p>4. Check if the procedures are implemented in correct way, and whether means of transport and equipment are used in correct way.</p> <p>5. Check whether employees comply with the rules on the maximum permitted driving speed on the operating surface.</p> <p>6. Check whether there are unnecessary detentions of vehicles and other means and equipment on the service road or at the apron.</p> <p>7. Check the technical fitness and equipment of all vehicles and other means.</p>
						O12	Passengers	<p>ORGANISATIONAL INDICATOR</p>
						SPI11	LIRF and loadsheet crosscheck	<p>1. Conduct inspection in the area of LIRF and loadsheet crosscheck; check whether the procedures are carried out in accordance with the regulations; established findings can reveal omissions and help define specific mitigation measures.</p> <p>2. Check whether the personnel who carry out LIRF and loadsheet crosscheck is qualified to perform the tasks, and whether all refreshers are carried out on time.</p> <p>3. Check in particular whether all employees have undergone training in the field of safety and human factors, and whether they are familiar with all safety problems in their field of work.</p> <p>4. Check the accuracy of all data on the loadsheet, i.e., destination, flight number, registration, aircraft type, crew, and flight date, and whether it is correctly signed by the responsible persons.</p> <p>5. Check the accuracy of entered operating weights and the weight of passengers and baggage.</p> <p>6. Check the correctness of other documentation according to prescribed requirements.</p>
						SPI10	Manoeuvring area maintenance	<p>1. Conduct inspection in the manoeuvring area maintenance; check whether the procedures in the manoeuvring area maintenance are carried out in accordance with the regulations; established findings can reveal omissions and help define specific mitigation measures.</p> <p>2. Check whether the personnel who carry out procedures in the manoeuvring area maintenance is qualified to perform the tasks, and whether all refreshers are carried out on time.</p> <p>3. Check in particular whether all employees have undergone training in the field of safety and human factors, and whether they are familiar with all safety problems in their field of work.</p> <p>4. Check whether there is major damage to the pavement of the manoeuvring area.</p> <p>5. Check whether there are one or more foreign objects on the pavement of the manoeuvring area that may endanger the safety of the aircraft (FOD).</p> <p>6. Check whether there are greasy stains from lubricants, motor oil, fuel, or the like on the pavement of the manoeuvring area.</p> <p>7. Check the correctness of horizontal and vertical signalisation on the manoeuvring area.</p> <p>8. Check whether all vehicles, means and equipment are placed in their designated places.</p>

	September 2022	4-6 months	SPI24	Number of occurrences related to wildlife	Wildlife	2	<ol style="list-style-type: none"> <li>1. Adjust flight schedules where possible, to minimize the chance of a strike with wildlife species that have predictable pattern of movement.</li> <li>2. Temporarily close a runway with unusually high bird activity or a large mammal incursion until wildlife control personnel can disperse the animals.</li> <li>3. Reduces, eliminate, or exclude one or more of elements that attract wildlife, such as food, cover or standing water.</li> <li>4. Minimize exposed areas that birds can use for perching and nesting.</li> <li>5. Build a fence or net to prevent wildlife into the airport area.</li> <li>6. Use repellent and harassment techniques to make the wildlife uncomfortable or fearful.</li> <li>7. Conduct regular patrols of airside areas to disperse birds and other hazardous wildlife.</li> </ol>	011	Aircraft operations	ORGANISATIONAL INDICATOR
		October 2022	4-6 months	SPI15	Number of occurrences related to passenger handling at the gate	Passenger handling at the gate	1	<ol style="list-style-type: none"> <li>1. Conduct inspection related to passenger handling at the gate; check whether the procedures are carried out in accordance with the regulations; established findings can reveal omissions and help define specific mitigation measures.</li> <li>2. Check whether the personnel who carry out procedures of passenger handling at the gate is qualified to perform the tasks, and whether all refreshers are carried out on time.</li> <li>3. Check in particular whether all employees have undergone training in the field of safety and human factors, and whether they are familiar with all safety problems in their field of work.</li> <li>4. Check how passenger security check is conducted at the gate; whether it is carried out efficiently, and in accordance with the regulations.</li> <li>5. Check the technical fitness of equipment and systems used to handle passengers at the gate.</li> </ol>	SPI11	Communication
								SPI14	FOD presence	<ol style="list-style-type: none"> <li>1. Conduct inspection in the area related to FOD presence; check whether the procedures in the area are carried out in accordance with the regulations; established findings can reveal omissions and help define specific mitigation measures.</li> <li>2. Check whether the personnel who carry out procedures in the area related to FOD presence is qualified to perform the tasks, and whether all refreshers are carried out on time.</li> <li>3. Check in particular whether all employees have undergone training in the field of safety and human factors, and whether they are familiar with all safety problems in their field of work.</li> <li>4. Inspect the stand before parking the aircraft to detect FOD presence (FOD check).</li> <li>5. Inspect manoeuvring surfaces to detect FOD presence (FOD check).</li> </ol>
								011	Aircraft operations	ORGANISATIONAL INDICATOR
								SPI7	Training deficiencies	<ol style="list-style-type: none"> <li>1. Conduct inspection of the personnel training procedures; check whether the procedures are carried out in accordance with the regulations; established findings can reveal omissions and help define specific mitigation measures.</li> <li>2. Check whether the personnel who carry out training is qualified, and whether training materials are up to date and carried out on time.</li> <li>3. Check in particular whether all employees have undergone training in the field of safety and human factors, and whether they are familiar with all safety problems related to training deficiencies.</li> </ol>
								SPI21	Ground traffic (GSE) and vehicle driving	<ol style="list-style-type: none"> <li>1. Conduct inspection in the area of ground traffic (GSE) and vehicle driving; check whether the procedures in this area are carried out in accordance with the regulations; established findings can reveal omissions and help define specific mitigation measures.</li> <li>2. Check whether the personnel who carry out tasks in the area of ground traffic (GSE) and vehicle driving is qualified to perform the tasks, and whether all refreshers are carried out on time.</li> <li>3. Check in particular whether all employees have undergone training in the field of safety and human factors, and whether they are familiar with all safety problems in their field of work.</li> <li>4. Check if the procedures are implemented in correct way, and whether means of transport and equipment are used in correct way.</li> <li>5. Check whether employees comply with the rules on the maximum permitted driving speed on the operating surface.</li> <li>6. Check whether there are unnecessary detentions of vehicles and other means and equipment on the service road or at the apron.</li> <li>7. Check the technical fitness and equipment of all vehicles and other means.</li> </ol>
								SPI23	Engine start-up	<ol style="list-style-type: none"> <li>1. Conduct inspection related to engine start-up procedures; check whether the procedures are carried out in accordance with the regulations; established findings can reveal omissions and help define specific mitigation measures.</li> <li>2. Check whether the personnel who carry out procedures is qualified and trained to perform the tasks, and whether all refreshers are carried out on time.</li> <li>3. Check in particular whether all employees have undergone training in the field of safety and human factors, and whether they are familiar with all safety problems in their field of work.</li> <li>4. Check whether before engine start-up, an inspection of the aircraft was carried out in order to detect any defects or damage.</li> </ol>

Source: Author

## 9 CONCLUSION

The dissertation is composed of 9 chapters: an introduction, seven chapters of thematic research and results, and a conclusion.

In the introductory chapter, review of previous research related to the topic of the predictive safety management methodology in aviation is discussed, the aim and hypotheses are set, as well as the methodology, research plan, and expected scientific contribution of the proposed research.

Chapter 2 of the dissertation describes safety management in aviation, including historical development of aviation safety management, safety concepts, functions, and aspects in aviation, development phases of aviation safety management system, comparison of traditional and modern approach to safety management, concepts of accident causation in aviation, definition of aviation safety management system, aim and purpose of establishing an aviation safety management system, regulatory and operational requirements of the aviation safety management system, basic ICAO framework: components and elements of the aviation safety management system, implementation of the aviation safety management system, safety risk management and safety assurance as the core components of an effective aviation safety management system, and finally comprehensive overview of the aviation safety management system.

Chapter 3 of the dissertation describes specific part of safety management in aviation, i.e., safety performance management. Core elements of safety performance management include safety data collection and processing systems, safety data analysis (descriptive, inferential, predictive, combined), data-driven decision-making and its process, advantages, and challenges, safety objectives, safety performance indicators, safety performance targets and safety triggers.

Chapter 4 of the dissertation analyses aviation safety management methodologies and applicable methods. It includes analysis of basic aviation safety management methodologies (reactive, proactive, predictive), application of predictive methods in aviation industry, analysis of types of analytical methods such as descriptive statistics, frequency histogram, stem-and-leaf plots, Q-Q plots, box plots and tests of normality, analysis of predictive methods used for forecasting in aviation, i.e., general overview of forecasting methods including trend projection, nonseasonal exponential smoothing, seasonal exponential smoothing, moving average method, auto regressive integrated moving average (ARIMA), and econometric analysis, as well as analysis of predictive methods used for forecasting in specific segments of aviation industry (air navigation services, airport operations, and airline operations). Based on analysis of predictive methods, selection and overview of predictive methods applicable in aviation safety management is presented.

Chapter 5 of the dissertation describes detected liaison between aviation safety management methodologies. Chapter includes theoretical overview of safety performance indicators as a bridge between safety management methodologies and case study conducted on the sample aviation organisation, i.e., pilot training organisation. The focus was to show the liaison between proactive and predictive safety management methodology in aviation. Based on safety data of



pilot training organisation, two examples of application of safety management methodologies were conducted. First example showed the proactive methodology that is actually used in pilot training organisation, with defined organisation's safety performance indicators and set safety performance targets. The results show how proactive methodology is used to monitor safety performance of the organisation. Second example shows possible way of using predictive methods to enhance existing proactive methodology, i.e., predictive methodology. The same safety data, safety performance indicators and safety performance targets were used to show the liaison between proactive and predictive methodology and possible upgrade of proactive methodology with predictive one. The predictive methods (trend analysis and moving average) were used to forecast future fluctuation of safety data and safety performance indicators. Two examples in this paper showed that both methodologies use same input data, i.e., safety data obtained from safety reporting systems which therefore shows the liaison between two methodologies. Second example also revealed that predictive methodology may act as an upgrade for proactive methodology, as it can analyse values of safety performance indicators to predict their future behaviour pattern.

Chapter 6 of the dissertation includes two parts. By using predictive analytics software, it is possible to create a causal models of all variables in observed data set, and predict the future scenarios, using such causal models. This chapter shows how predictive methods and causal modelling methods can be useful in the aspect of aviation safety. First part defines a link between causation and prediction (theoretical overview), presenting connections between causal factors and predicted events. Second part is case study of predictive analysis and causal modelling of organisational and safety performance indicators conducted on the sample aviation organisation, i.e., aviation training organisation. This part includes analysis of an organisation's safety database, analysis of organisational and safety performance indicators of an aviation training organisation using statistics methods, forecasting of safety performance indicators of an aviation training organisation using predictive methods, causal modelling of organisational and safety performance indicators of an aviation training organisation, and predicting safety performance indicators using predictive methods and causal modelling, creating case scenarios and their analyses. This research proved that there are relations between organisational and safety performance indicators in the organisation, and by revealing that, opened up the possibility to know which indicators to increase or decrease in order to obtain desired level of safety performance in the organisation.

Chapter 7 of the dissertation presents conceptual model of predictive safety management in aviation. New conceptual model of predictive safety management, which is developed, represents an upgrade to previous reactive and proactive safety management methodologies. The research conducted in previous chapters, helped establish steps and tools of predictive safety management methodology. Predictive safety management methodology ensures obtaining information on organisation's safety performance in the future period, and through that, detects future adverse occurrences by using predictive methods and provides mitigation tools to react before adverse event occurs by using causal modelling methods.

Chapter 8 of the dissertation includes validation and verification of conceptual model of predictive safety management on the sample airport (Split Airport). Validation and verification

of conceptual model of predictive safety management is conducted through analysis of Split Airport safety database, causal modelling of Split Airport organisational and safety performance indicators, outlier root cause analysis of Split Airport safety performance indicators, predictive analysis of safety performance (forecasting of Split Airport organisational and safety performance indicators), predictive analysis and causal modelling (scenario cases for Split Airport), and expanded set of safety performance indicators for Split Airport. Based on the conducted analysis using predictive safety management methodology, summary of results and proposal of mitigation measures are presented for Split Airport.

Working hypotheses of the doctoral dissertation were:

- H1. existing safety management methodologies are inadequate, and upgrading safety management with predictive methodology could improve safety management in aviation organisations,
- H2. by developing predictive safety management in aviation, hazards that may arise in the future could be detected and identified, which would ensure earlier response, mitigation measures, and continuing maintenance of an acceptable level of safety in aviation organisations.

First hypothesis (H1) assumes that existing safety management methodologies are inadequate and upgrading safety management with predictive methodology could improve safety management in aviation organisations.

Proof: Based on analysis of basic methodologies (reactive, proactive, predictive) established in aviation safety management, it has been concluded that most organisations use reactive or proactive safety management methodology. Predictive safety management methodology is not yet well established nor used. Predictive methodology in a current form uses real-time analytics software to analyse large amounts of flight data to detect emerging hazards but does not include predictive (forecasting) methods in the process. On the other hand, predictive (forecasting) methods are used in aviation industry, mostly for planning purposes of future capacity or traffic demand but not in the segment of aviation safety management. Analysing the performance of existing safety methodologies (reactive and proactive) in the sample aviation organisations, showed the constant increase in number of adverse occurrences in some organisations, especially in last few years, which proves inadequacy of implemented safety management methodologies in those organisations. Due to constant increase in air transport activities and traffic, including introduction of new technologies and equipment in the aviation sector, it is necessary, and almost inevitable, to keep in track with all changes future aviation brings, and with all future hazards that come with those changes. This dictates the necessity for improved safety management that can cope with new and larger scope of future hazards. Hence, developing an improved aviation safety management with predictive upgrade is an imperative to keep acceptable safety performance level at each aviation organisation.

Second hypothesis (H2) assumes that by developing predictive safety management in aviation, hazards that may arise in the future could be detected and identified, which would ensure earlier response, mitigation measures, and continuing maintenance of an acceptable level of safety in aviation organisations.

Proof: As already stated, constant increase in air transport activities and traffic, including introduction of new technologies and equipment in the aviation sector, dictates the necessity for improved safety management that can cope with new and larger scope of future hazards. Hence, developing an improved aviation safety management is an imperative. This thesis presents conceptual model of improved safety management, i.e., predictive safety management that use of predictive (forecasting) and causal modelling methods to identify potential and possible hazards in the future, as well as their causal factors which can help define timely and efficient mitigation measures to prevent or restrain emerging hazards turning into adverse events. The conceptual model of predictive safety management was validated and verified on the sample airport (Split Airport) and proved efficient in detecting future hazards, and causal factors, as well as in generating appropriate mitigation measures for the purpose of continuing maintenance of an acceptable level of safety in an organisation.

Based on the hypotheses set, defined aim and results of the proposed research, the following scientific contributions are achieved:

- an expanded set of organisation's safety performance indicators in an aviation organization is defined,
- conceptual model of predictive safety management in aviation is developed.

First scientific contribution expected to define an expanded set of organisation's safety performance indicators in an aviation organization. Expanding the set of organisation's safety performance indicators was performed on a sample airport, i.e., Split Airport. There were 25 defined safety performance indicators (SPIs) that each measure designated part of Split Airport business, i.e., its safety-related outcomes. Due to analysis of registered occurrences at the sample airport, i.e., Split Airport, and in cooperation of Split Airport Safety Department, new occurrences (events) had been detected related to the medical emergency landings at the airport. The safety performance indicator had not yet been assigned to this area, but the events had been recorded. It was assumed that these events affect safety and that it would be useful to monitor them via safety performance indicator in the future. These events were placed under the category of newly established safety performance indicator SPI26 named Number of occurrences related to medical emergency landings. It was presented how causal modelling methods of predictive safety management can be used to confirm impact relations and relevance to safety of newly established safety performance indicator. Causal analysis has detected impact relations of newly established safety performance indicator SPI26 – Number of occurrences related to medical emergency landings with six other safety performance indicators, proving with it, its relevance to safety performance. Hence, proving the relevance regarding safety and including newly established safety performance indicator SPI26 – Number of occurrences related to medical emergency landings, into the existing set of safety performance indicators, the total set of safety performance indicators at the Split Airport, had been expanded.

Second scientific contribution expected to develop conceptual model of predictive safety management in aviation. The research conducted in this thesis, defined steps and tools of predictive safety management methodology. By analysing the existing methodologies in aviation safety management, it has been established that three methodologies were used, i.e., reactive, proactive and predictive. By looking closely at each of these safety management methodologies,

necessary inputs (safety data) and tools used, were detected and described. It was observed that proactive safety management methodology acts as an upgrade to reactive one. Next step in the research, was the analysis of existing predictive safety management methodology, and it has been concluded, that existing predictive safety management methodology refers to flight data monitoring and analysis in the real-time. It does not actually implement the usage of predictive methods, but it is considered to be “predictive” because by gathering real-time data and analysing them gives the organisation insights in future emerging hazards, hence organisations can anticipate, i.e., “predict” upcoming future hazards. It is also observed that existing “predictive” methodology, besides using tools of real-time flight data monitoring and analysis, also use the same safety data and information that is used by reactive and proactive safety management methodology, as inputs to make “predictive” analysis. Hence, it was observed that existing predictive safety management methodology acts as an upgrade to proactive one, as well. After establishing correlations between all existing safety management methodologies, the aim was to expand existing predictive safety management methodology with introducing usage of predictive methods and causal modelling methods in the area of safety performance management. By predicting safety performance indicators with usage of predictive methods, which are proactively monitored in an organisation, future hazards can be detected and anticipated. Using causal modelling methods, as another useful tool, causal relations between safety performance indicators (occurrences) can be detected and provide the organisation with the tool to mitigate anticipated future events (occurrences) in an organisation. Due to conducted research regarding safety management methodologies, new conceptual model of predictive safety management, was developed, representing an upgrade to previous reactive and proactive safety management methodologies, and introducing use of predictive methods and causal modelling methods in the area of safety performance management.

In the future research, the focus will be to define improved cause-sequenced breakdown of hazard/occurrence categories (SPIs) in order to obtain specific safety performance indicators related to each organisational area of activity. These categories could help define extensive set of organisational and safety performance indicators that can be monitored, analysed and predicted to mitigate or prevent future emerging hazards in the organisation. Improving safety data input process, in general, would make predictive safety management methodology more efficient and useful.

Future research will be focused on implementing predictive and causal modelling methods in a total management system, at the organisational level, as well. The intention is to capillary integrate safety management system within a total management system of the organisation. This would allow an organisation to consider all the interactions (causal relations) throughout the whole organisational system, that impact directly or indirectly organisation’s safety performance.

During this research, specifically in process of detecting new occurrences that could be monitored via safety performance indicators, there were occurrences, for example, related to PBN implementation at the Split Airport but aren't and couldn't be established for monitoring via SPI, as the airport operator wasn't in charge to monitor these events, because such events are exclusively monitored by ANSP. It has been observed that this indicator should be monitored as

intra-relating performance indicator of air traffic management and airport management, proving the necessity of introducing collaborative decision-making (CDM) between different service providers. Future research shall investigate the possibilities of establishing such intra-relating performance indicators with a purpose of introducing collaborative decision-making (CDM) between different service providers, related to detecting and mitigating hazards that impact multiple sectors in aviation. In the first phase, CDM between airport operator and air traffic services could be introduced, and subsequently, at the later date, an upgrade to CDM between the airport operator, air traffic services and airlines, as well.

## REFERENCES

- [1] Adjekum, D. K., 2014. Safety Management Systems in Aviation Operations in the United States: Is the Return on Investment Worth the Cost? *Prime Journal of Business Administration and Management (BAM)*, 4(1), pp. 1442-1450.
- [2] Adjekum, D. K. & Tous, M. F., 2020. Assessing the Relationship between Organizational Management Factors and a Resilient Safety Culture in a Collegiate Aviation Program with Safety Management Systems (SMS). *Safety Science*, 131(1), pp. 1-15, DOI: 10.1016/j.ssci.2020.104909.
- [3] AFCAC, 2019. *Mechanism for Monitoring Implementation of Safety Systems & Initiatives*. Dakar-Yoff: African Civil Aviation Commission.
- [4] AG-DASA, 2015. *TAREG 4.4.4 Safety Management Systems in Maintenance*. Canberra: Australian Government, Defence Aviation Safety Authority.
- [5] Airbus, 2014. Flight Data Analysis (FDA), a Predictive Tool for Safety Management System (SMS) [Airbus Safety Magazine: Safety First, Issue 17], Online: [https://safetyfirst.airbus.com/app/themes/mh\\_newsdesk/pdf.php?p=25663](https://safetyfirst.airbus.com/app/themes/mh_newsdesk/pdf.php?p=25663) [29 May 2020].
- [6] Akinyemy, Y. C., 2018. Determinants of Domestic Air Travel Demand in Nigeria: Cointegration and Causality Analysis. *Geojournal*, 84(5), pp. 1239-1256, DOI: 10.1007/s10708-018-9918-8.
- [7] Akyuz, E., 2017. A Marine Accident Analysing Model to Evaluate Potential Operational Causes in Cargo Ships. *Safety Science*, 92(1), pp. 17-25, DOI: 10.1016/j.ssci.2016.09.010.
- [8] Albery, S., Borys, D. & Tepe, S., 2016. Advantages for Risk Assessment: Evaluating Learnings from Question Sets Inspired by the FRAM and the Risk Matrix in a Manufacturing Environment. *Safety Science*, 89(1), pp. 180-189, DOI: 10.1016/j.ssci.2016.06.005.
- [9] Ale, B. J. M., Bellamy, L. J., van der Boom, R., Cooper, J., Cooke, R. M., Goossens, L. H. J., Hale, A. R., Kurowicka, D., Morales, O., Roelen, A. L. C. & Spouge, J., 2009. Further Development of a Causal Model for Air Transport Safety (CATS): Building the Mathematical Heart. *Reliability Engineering & System Safety*, 94(9), pp. 1433-1441, DOI: 10.1016/j.ress.2009.02.024.
- [10] Al-shanini, A., Ahmad, A. & Khan, F., 2014. Accident Modelling and Analysis in Process Industries. *Journal of Loss Prevention in the Process Industries*, 32(1), pp. 319-334, DOI: 10.1016/j.jlp.2014.09.016.
- [11] Ancel, E., Shih, A. T., Jones, S. M., Reveley, M. S. & Luxhøj, J., 2015. Predictive Safety Analytics: Inferring Aviation Accident Shaping Factors and Causation. *Journal of Risk Research*, 18(4), pp. 428-451, DOI: 10.1080/13669877.2014.896402.

- [12] Apostolakis, G., 1990. The Concept of Probability in Safety Assessments of Technological Systems. *Science*, 250(1), pp. 1359-1364, DOI: 10.1126/science.2255906.
- [13] Araujo Vieir, E. M., Norte da Silva, J. M. & Silva, L., 2017. Modeling Bayesian Networks from a Conceptual Framework for Occupational Risk Analysis. *Production*, 27(1), pp. 1-12, DOI: 10.1590/0103-6513.223916.
- [14] Atmanspacher, H. & Filk, T., 2012. Determinism, Causation, Prediction, and the Affine Time Group. *Journal of Consciousness Studies*, 19(5-6), pp. 75-94.
- [15] Attwood, D., Khan, F. & Veitch, B., 2006. Can We Predict Occupational Accident Frequency? *Process Safety and Environmental Protection*, 84(3), pp. 208-221, DOI: 10.1205/psep.05113.
- [16] Attwood, D., Khan, F. & Veitch, B., 2006. Occupational Accident Models – Where Have We Been and Where Are We Going? *Journal of Loss Prevention in the Process Industries*, 19(6), pp. 664-682, DOI: 10.1016/j.jlp.2006.02.001.
- [17] Badreddine, A. & Ben Amor, N., 2013. A Bayesian Approach to Construct Bow Tie Diagrams for Risk Evaluation. *Process Safety and Environmental Protection*, 91(3), pp. 159-171, DOI: 10.1016/j.psep.2012.03.005.
- [18] Baksi, A. K. & Parid, B. B., 2020. Impact of Responsible Tourism Metrics on Socio-Environmental Indicators in Post Covid-19 Environment: A Predictive Analysis Using Temporal Causal Modelling. Kerala: School of Tourism Studies, Mahatma Gandhi University: 1st Asian Tourism Research Conference: Interpreting the Landscape of Asian Tourism, 1-3 December 2020, pp. 379-399.
- [19] Bartulović, D., 2012. *Risk Assessment Methodology in Air Traffic Safety Management System* [Master Thesis]. Zagreb: Faculty of Transport and Traffic Sciences.
- [20] Bartulović, D., 2021. Predictive Safety Management System Development. *Transactions on Maritime Science*, 10(1), pp. 135-146, DOI: 10.7225/toms.v10.n01.010.
- [21] Bartulović, D. & Steiner, S., 2020. Liaison between Proactive and Predictive Methodology of Aviation Safety Management System. Portorož, Slovene Association of Transport Sciences: 19th International Conference on Transport Science, 17-18 September 2020.
- [22] Bartulović, D. & Steiner, S., 2022. Cause-Effect Relations between Organizational and Safety Performance Indicators. Portorož, Slovene Association of Transport Sciences: 20th International Conference on Transport Science, 23-24 May 2022.
- [23] BCAA, 2010. *Manual on Aerodrome Safety Management System*. Dhaka: Civil Aviation Authority of Bangladesh.
- [24] Bedford, T. & Cooke, R., 2001. *Probabilistic Risk Analysis: Foundations and Methods*. New York, NY: Cambridge University Press.

- [25] Beebee, H., Hitchcock, C. & Menzies, P., 2009. *The Oxford Handbook of Causation*. Oxford: Oxford University Press.
- [26] Belobaba, P. P., Odoni, A., Barnhart, C., 2009. *The Global Airline Industry*, London: John Wiley & Sons.
- [27] Ben, B., Cui, L., Chen, H., Liu, M. & Wang, F., 2019. A New Method for Aviation Safety Prediction Based on the Highest Density Domain in Uncertainty Environment. IEEE, 5th International Conference on Control Science and Systems Engineering (ICCSSE 2019), 14-16 August 2019, pp. 5-9, DOI: 10.1109/ICCSSE.2019.00009.
- [28] BHDCA, 2014. *[Instruction on Risk Management in the Flight Safety System]*. Banja Luka: Bosnia and Herzegovina Directorate of Civil Aviation.
- [29] Biernbaum, L. & Hagemann, G., 2012. *Runway Incursion Severity Risk Analysis (DOT-VNTSC-FAA-12-13)*. Cambridge, MA: Volpe National Transportation Systems Center.
- [30] Boeing, 2012. Boeing Safety Management System Overview, Online: <http://www.aviationunion.ru/Files/7%20En%20Boeing%20SMS%20Overview.pdf> [29 May 2020].
- [31] Bohm, F., 2008. Einführung von Safety Management Systemen im Flugbetrieb, Online: [https://www.lba.de/SharedDocs/Downloads/DE/B/B2\\_Flugbetrieb/Rundschreiben/94\\_RS\\_2008\\_16\\_Praesentation.pdf?\\_\\_blob=publicationFile&v=1](https://www.lba.de/SharedDocs/Downloads/DE/B/B2_Flugbetrieb/Rundschreiben/94_RS_2008_16_Praesentation.pdf?__blob=publicationFile&v=1) [29 May 2020].
- [32] Brockwell, P. J. & Davis, R. A., 2016. *Introduction to Time Series and Forecasting, 3rd Edition*. New York, Springer International Publishing.
- [33] Buehner, M. J., 2012. Understanding the Past, Predicting the Future: Causation, Not Intentional Action, Is the Root of Temporal Binding. *Psychological Science*, 23(12), pp. 1490-1497, DOI: 10.1177/0956797612444612.
- [34] Bugayko, D., Isaienko, V., Sokolova, N., Leshchynskiy, O. & Zamiar, Z., 2019. Analysis of the Aviation Safety Management System by Fractal and Statistical Tools. *Logistics and Transport*, 44(4), pp. 41-60, DOI: 10.26411/83-1734-2015-4-44-5-19.
- [35] Burin, J., 2013. Being Predictive in a Reactive World, ISASI Journal, 46(1), Online: <https://www.skybrary.aero/bookshelf/books/3337.pdf> [21 June 2020].
- [36] Button, K. & Yuan, J., 2013. Airfreight Transport and Economic Development: An Examination of Causality. *Urban Studies*, 50(2), pp. 329-340, DOI: 10.1177/0042098012446999.
- [37] CAA NZ, 2013. *Aviation Risk Management*. Wellington: Civil Aviation Authority of New Zealand.
- [38] Cacciabue, P. C., 2004. *Guide to Applying Human Factors Methods – Human Error and Accident Management in Safety Critical Systems*. London: Springer.



- [39] Canders, M. F., 2016. Peer Reviewed Safety Management System (SMS): Collaboration for Continuous Improvement (Literature Review). *International Journal of Aviation, Aeronautics, and Aerospace*, 3(2), pp. 1-14, DOI: 10.15394/ijaaa.2016.1113.
- [40] Cartwright, N., 2004. Causation: One Word, Many Things. *Philosophy of Science*, 71(5), pp. 805-819, DOI: 10.1086/426771.
- [41] CCAA, 2021. *Implementation of Safety Management Systems (SMS): Air Safety Order ASO-2010-004, Revision 5*. Zagreb: Croatian Civil Aviation Agency.
- [42] CG, 2015. [State Safety Programme] NN 141/2015. Zagreb: Croatian Government.
- [43] CG, 2015. *Ordinance on the Implementation of Regulation (EU) 376/2014* [NN 107/2015, 92/2016, 28/2019]. Zagreb: Croatian Government.
- [44] Chatzi, A. V., 2019. Safety Management Systems: An Opportunity and a Challenge for Military Aviation Organisations. *Aircraft Engineering and Aerospace Technology*, 91(1), pp. 190-196, DOI: 10.1108/AEAT-05-2018-0146.
- [45] Chen, M., Chen, Y. & Ma, S., 2021. Identifying Safety Performance Indicators for Risk Assessment in Civil Aviation. Shaanxi, IOP Publishing: IOP Conference Series: Materials Science and Engineering, The 10th International Conference on Quality, Reliability, Risk, Maintenance, and Safety Engineering (QR2MSE 2020), 8-11 October 2020, pp. 1-7.
- [46] Chen, M., Luo, M., Zhang, Y. & Chen, Y., 2019. A Framework to Quantitatively Assess Safety Performance for Civil Aviation Organization. Orlando, FL, International Conference on Human-Computer Interaction: HCII 2019: Digital Human Modeling and Applications in Health, Safety, Ergonomics and Risk Management. Human Body and Motion, 26-31 July 2019, pp. 369-381.
- [47] Chen, W. & Li, J., 2016. Safety Performance Monitoring and Measurement of Civil Aviation Unit. *Journal of Air Transport Management*, 57(1), pp. 228-233, DOI: 10.1016/j.jairtraman.2016.08.015.
- [48] Cusick, S. K., Cortes, A. I. & Rodrigues, C. C., 2017. *Commercial Aviation Safety, 6th Edition*. New York: McGraw-Hill.
- [49] Čokorilo, O. & Dell'Acqua, G., 2013. Aviation Hazards Identification Using Safety Management System (SMS) Techniques. Portorož, 16th International Conference on Transport Science (ICTS 2013).
- [50] Čokorilo, O., Ivković, I. & Kaplanović, S., 2019. Prediction of Exhaust Emission Costs in Air and Road Transportation. *Sustainability*, 11(17), pp. 1-18, DOI: 10.3390/su11174688.
- [51] Čokorilo, O., Miroslavljević, P. & Gvozdenović, S., 2011. An Approach to Safety Management System (SMS) Implementation in Aircraft Operations. *African Journal of Business Management*, 5(5), pp. 1942-1950.
- [52] de Carvalho, P. V. R., 2011. The Use of Functional Resonance Analysis Method (FRAM) in a Mid-Air Collision to Understand Some Characteristics of the Air Traffic Management

- System Resilience. *Reliability Engineering & System Safety*, 96(11), pp. 1482-1498, DOI: 10.1016/j.ress.2011.05.009.
- [53] Delikhoon, M., Zarei, E., Valdez Banda, O., Faridan, M. & Habibi, E., 2022. Systems Thinking Accident Analysis Models: A Systematic Review for Sustainable Safety Management. *Sustainability*, 14(10), pp. 1-28, DOI: 10.3390/su14105869.
- [54] Di Gravio, G., Mancini, M., Patriarca, R. & Costantino, F., 2015. Overall Safety Performance of Air Traffic Management System: Forecasting and Monitoring. *Safety Science*, 72(1), pp. 351-362, DOI: 10.1016/j.ssci.2014.10.003.
- [55] Dien, Y., Dechy, N. & Guillaume, E., 2012. Accident Investigation: From Searching Direct Causes to Finding In-Depth Causes – Problem of Analysis or/and of Analyst? *Safety Science*, 50(6), pp. 1398-1407, DOI: 10.1016/j.ssci.2011.12.010.
- [56] Doran, G. T., 1981. There's a S.M.A.R.T. Way to Write Management's Goals and Objectives. *Management Review*, 70(11), pp. 35-36.
- [57] Duanmu, J. S., Ma, Z. Y. & Chang, H., 2013. *Theoretical Methods of Aviation Accident Prediction, Early Warning and Prevention*. Beijing: National Defense Industry Press.
- [58] Du, H. B. & Qin, P. H., 2011. Time-Series Extrapolation Analysis Model for Short-Term Prediction of Flight Accidents in American General Aviation. *Journal of Safety and Environment*, 11(3), pp. 208-211.
- [59] EASA, 2011. Commission Regulation (EU) No 1178/2011 Laying down Technical Requirements and Administrative Procedures Related to Civil Aviation Aircrew; Part-ORA. Cologne: European Union Aviation Safety Agency.
- [60] EASA, 2012. Commission Regulation (EU) No 965/2012 Laying down Technical Requirements and Administrative Procedures Related to Air Operations; Part-ORO. Cologne: European Union Aviation Safety Agency.
- [61] EASA, 2014. Commission Regulation (EU) No 1321/2014 on the Continuing Airworthiness of Aircraft and Aeronautical Products, Parts and Appliances, and on the Approval of Organisations and Personnel Involved in these Tasks; Part-145 and Part-M. Cologne: European Union Aviation Safety Agency.
- [62] EASA, 2014. Commission Regulation (EU) No 139/2014 Laying down Requirements and Administrative Procedures Related to Aerodromes, Part-ADR.OR. Cologne: European Union Aviation Safety Agency.
- [63] EASA, 2014. Regulation (EU) No 376/2014 on the Reporting, Analysis, and Follow-up of Occurrences in Civil Aviation. Cologne: European Union Aviation Safety Agency.
- [64] EASA, 2015. Commission Implementing Regulation (EU) 2015/1018 of 29 June 2015 Laying down a List Classifying Occurrences in Civil Aviation to be Mandatorily Reported. Cologne: European Union Aviation Safety Agency.

- [65] Eastwell, P. H., 2012. Hypothesis, Prediction, and Conclusion: Using Nature of Science Terminology Correctly. *The Science Education Review*, 11(1), pp. 37-43.
- [66] Eastwell, P. H., 2014. Understanding Hypotheses, Predictions, Laws, and Theories. *The Science Education Review*, 13(1), pp. 16-21.
- [67] Ellis, K. K., Krois, P., Koelling, J., Prinzel, L. J., Davies, M. & Mah, R., 2021. A Concept of Operations (ConOps) of an In-time Aviation Safety Management System (IASMS) for Advanced Air Mobility (AAM). Virtual, AIAA Scitech 2021 Forum, 11-15 & 19-21 January, pp. 1-14, DOI: 10.2514/6.2021-1978.
- [68] Elvik, R. & Elvebakk, B., 2016. Safety Inspectorates and Safety Performance: A Tentative Analysis for Aviation and Rail in Norway. *Safety*, 2(2), pp. 1-11, DOI: 10.3390/safety2020013.
- [69] Erjavac, A. J., Iammartino, R. & Fossaceca, J. M., 2018. Evaluation of Preconditions Affecting Symptomatic Human Error in General Aviation and Air Carrier Aviation Accidents. *Reliability Engineering & System Safety*, 178(1), pp. 156-163, DOI: 10.1016/j.ress.2018.05.021.
- [70] EUROCONTROL, 2021. EUROCONTROL Forecast Update 2021-2027, Online: <https://www.eurocontrol.int/publication/eurocontrol-forecast-update-2021-2027> [4 April 2022].
- [71] Everdij, M. H. C., Blom, H. A. P. & Kirwan, B., 2006. Development of A Structured Database of Safety Methods. New Orleans, LA, Proceedings of the 8th International Conference on Probabilistic Safety Assessment & Management (PSAM8), 14-18 May 2006.
- [72] Ferdous, R., Khan, F., Sadiq, R., Amyotte, P. & Veitch, B., 2013. Analysing System Safety and Risk under Uncertainty Using a Bow-Tie Diagram. An Innovative Approach. *Process Safety and Environmental Protection*, 91(1-2), pp. 1-18, DOI: 10.1016/j.psep.2011.08.010.
- [73] Ferguson, M. D. & Nelson, S., 2014. *Aviation Safety: A Balanced Industry Approach, 1st Edition*. New York: Delmar.
- [74] Ferjencik, M., 2011. An Integrated Approach to the Analysis of Incident Causes. *Safety Science*, 49(6), pp. 886-905, DOI: 10.1016/j.ssci.2011.02.005.
- [75] Ferjencik, M., 2014. IPICA\_Lite – Improvements to Root Cause Analysis. *Reliability Engineering & System Safety*, 131(1), pp. 1-13, DOI: 10.1016/j.ress.2014.06.004.
- [76] Fogarty, G. J. & Shaw, A., 2010. Safety Climate and the Theory of Planned Behavior: Towards the Prediction of Unsafe Behavior. *Accident Analysis & Prevention*, 42(5), pp. 1455-1459, DOI: 10.1016/j.aap.2009.08.008.
- [77] Ford, C., Jack, T., Crisp, V. & Sandusky, R., 1999. Aviation Accident Causal Analysis. *SAE Technical Paper*, pp. 1-33, DOI: 10.4271/1999-01-1432.

- [78] Franjo Tuđman Airport, 2022. Franjo Tuđman Airport Statistics, Online: <https://www.zagreb-airport.hr/poslovnib2b-223/statistika/statistika-za-2022-godinu/746> [3 April 2022].
- [79] GAIN Working Group B, 2003. Guide to Methods & Tools for Airline Flight Safety Analysis, Online: [https://flightsafety.org/files/methods\\_tools\\_safety\\_analysis.pdf](https://flightsafety.org/files/methods_tools_safety_analysis.pdf) [28 May 2020].
- [80] Georgiev, K., 2021. Aviation Safety Training Methodology. *Heliyon*, 7(12), pp. 1-8, DOI: 10.1016/j.heliyon.2021.e08511.
- [81] Ghobbar, A. A. & Friend, C. H., 2003. Evaluation of Forecasting Methods for Intermittent Parts Demand in the Field of Aviation: A Predictive Model. *Computers & Operations Research*, 30(14), pp. 2097-2114, DOI: 10.1016/S0305-0548(02)00125-9.
- [82] Gilliam, W. J., 2019. MINDSPACE and Development of Organizational Culture in Aviation Safety Management. *International Journal of Aviation, Aeronautics, and Aerospace*, 6(1), pp. 1-18, DOI: 10.15394/ijaaa.2019.1314.
- [83] Glymour, C., Madigan, D., Pregibon, D. & Smyth, P., 1996. Statistical Inference and Data Mining. *Communications of the ACM*, 39(11), pp. 35-41.
- [84] Goetsch, D. L., 2008. *Occupational Safety and Health for Technologists, Engineers, and Managers*. Upper Saddle River, NJ: Pearson Prentice Hall.
- [85] Google Maps, 2022. Split Airport, Online: <https://www.google.com/maps/> [8 July 2022].
- [86] Greene, W. H., 2003. *Econometric Analysis, 5th Edition*. New Jersey: Prentice Hall.
- [87] Granger, C. W. J., 1969. Investigating Causal Relations by Econometric Models and Cross-Spectral Methods. *Econometrica*, 37(3), pp. 424-438, DOI: 10.2307/1912791.
- [88] Granger, C. W. J., 1980. Testing for Causality: A Personal Viewpoint. *Journal of Economic Dynamics and Control*, 2(1), pp. 329-352, DOI: 10.1016/0165-1889(80)90069-X.
- [89] Granger, C. W. J., 1988. Some Recent Development in a Concept of Causality. *Journal of Econometrics*, 39(1-2), pp. 199-211, DOI: 10.1016/0304-4076(88)90045-0.
- [90] Grant, E., Salmon, P. M., Stevens, N. J., Goode, N. & Read, G. J., 2018. Back to the Future: What do Accident Causation Models Tell Us about Accident Prediction? *Safety Science*, 104(1), pp. 99-109, DOI: 10.1016/j.ssci.2017.12.018.
- [91] Grötschelová, K., Lališ, A. & Guskova, N., 2021. Systemic Safety Data Collection and Processing in Aviation Safety Oversight. Brno, 2021 International Conference on Military Technologies (ICMT), 08-11 June 2021, pp. 1-6.
- [92] Gui, F., 2013. *Safety Management: A Behavior-Based Approach to Accident Prevention*. Beijing: Science Press.
- [93] Gui, F., Xuecai, X., Qingsong, J., Zonghan, L., Ping, C. & Ying, G., 2019. The Development History of Accident Causation Models in the Past 100 Years: 24Model, a More Modern

- Accident Causation Model. *Process Safety and Environmental Protection*, 134(1), pp. 47-82, DOI: 10.1016/j.psep.2019.11.027.
- [94] Guskova, N., Lališ, A. & Grötschelová, K., 2020. Systemic Safety Data Collection and Processing in Aviation Maintenance. IEEE, 2020 New Trends in Civil Aviation (NTCA), 23-24 November 2020.
- [95] Hale, A., Wilpert, B. & Freitag, M., 1997. *After the Event. From Accidents to Organisational Learning*. Oxford: Pergamon.
- [96] Hall, N., 2004. *Two Concepts of Causation*. In: *Causation and Counterfactuals*. Cambridge, MA: MIT Press, pp. 225-276.
- [97] Hänninen, M. & Kujala, P., 2010. The Effects of Causation Probability on the Ship Collision Statistics in the Gulf of Finland. *International Journal on Marine Navigation and Safety of Sea Transportation*, 4(1), pp. 79-84.
- [98] Hänninen, M. & Kujala, P., 2012. Influences of Variables on Ship Collision Probability in a Bayesian Belief Network Model. *Reliability Engineering and System Safety*, 102(1), pp. 27-40, DOI: 10.1016/j.ress.2012.02.008.
- [99] Hastie, T., Tibshirani, R. & Friedman, J., 2009. *The Elements of Statistical Learning: Data Mining, Inference, and Prediction, 2nd Edition*. New York, NY: Springer.
- [100] Heinze-Deml, C., Maathuis, M. H. & Meinshausen, N., 2018. Causal Structure Learning. *Annual Review of Statistics and Its Application*, 5(1), pp. 371-391, DOI: 10.48550/arXiv.1706.09141.
- [101] Heinze-Deml, C., Peters, J. & Meinshausen, N., 2018. Invariant Causal Prediction for Nonlinear Models. *Journal of Causal Inference*, 6(2), pp. 1-35, DOI: 10.1515/jci-2017-0016.
- [102] Helmreich, R. L., 1998. Building Safety on the Three Cultures of Aviation. Bangkok, Proceedings of the IATA Human Factors Seminar, pp. 39-43.
- [103] Herrera, I. A. & Woltje, R., 2010. Comparing a Multi-Linear (STEP) and Systemic (FRAM) Method for Accident Analysis. *Reliability Engineering & System Safety*, 95(12), pp. 1269-1275, DOI: 10.1016/j.ress.2010.06.003.
- [104] Hofman, J. M., Sharma, A. & Watts, D. J., 2017. Prediction and Explanation in Social Systems. *Science*, 355(1), pp. 486-488, DOI: 10.1126/science.aal3856.
- [105] Holbrook, J., 2021. Exploring Methods to Collect and Analyze Data on Human Contributions to Aviation Safety. Corvallis, International Symposium on Aviation Psychology.
- [106] Hollnagel, E., 2004. *Barriers and Accident Prevention*. London: Ashgate Publishing Limited.

- [107] Hollnagel, E., 2014. *Safety-I and Safety-II: The Past and Future of Safety Management*. Farnham: Ashgate.
- [108] Hsiao, Y.-L., Drury, C., Wu, C. & Paquet, V., 2012. Predictive Models of Safety Based on Audit Findings: Part 1: Model Development and Reliability. *Applied Ergonomics*, 44(2), pp. 261-273, DOI: 10.1016/j.apergo.2012.07.010.
- [109] Hsiao, Y.-L., Drury, C., Wu, C. & Paquet, V., 2013. Predictive Models of Safety Based on Audit Findings: Part 2: Measurement of Model Validity. *Applied Ergonomics*, 44(4), pp. 659-666, DOI: 10.1016/j.apergo.2013.01.003.
- [110] Hulme, A., Stanton, N. A., Walker, G. H., Waterson, P. & Salmon, P. M., 2019. What do Applications of Systems Thinking Accident Analysis Methods Tell Us about Accident Causation? A Systematic Review of Applications between 1990 and 2018. *Safety Science*, 117(1), pp. 164-183, DOI: 10.1016/j.ssci.2019.04.016.
- [111] IBM, 2021. IBM SPSS Statistics, Online: <https://www.ibm.com/> [10 October 2021].
- [112] ICAO, 2005. *ICAO Accident Prevention Program*, Montreal: International Civil Aviation Organization.
- [113] ICAO, 2006. *Convention on International Civil Aviation, 9th Edition* [Doc 7300]. Montreal: International Civil Aviation Organization.
- [114] ICAO, 2007. *Manual on the Prevention of Runway Incursions* [Doc 9870 AN/463]. Montreal: International Civil Aviation Organization.
- [115] ICAO, 2011. *Safety Management Principles*. Montreal: International Civil Aviation Organization.
- [116] ICAO, 2013. *Global Aviation Safety Plan, 2014-2016 Edition*. Montreal: International Civil Aviation Organization.
- [117] ICAO, 2013. *State of Global Aviation Safety* [SGAS 2013]. Montreal: International Civil Aviation Organization.
- [118] ICAO, 2016. *Annex 13 to the Convention on International Civil Aviation: Aircraft Accident and Incident Investigation, 11th Edition*. Montreal: International Civil Aviation Organization.
- [119] ICAO, 2016. *Annex 19 to the Convention on International Civil Aviation: Safety Management, 2nd Edition*. Montreal: International Civil Aviation Organization.
- [120] ICAO, 2018. *Safety Management Manual (SMM), 4th Edition* [Doc 9859 AN/474]. Montreal(Quebec): International Civil Aviation Organization.
- [121] ICAO, 2019. *Global Aviation Safety Plan, 2020-2022 Edition* [Doc 10004]. Montreal: International Civil Aviation Organization.

- [122] Insua, D. R., Alfaro, C., Gomez, J., Hernandez-Coronado, P. & Bernal, F., 2018. A Framework for Risk Management Decisions in Aviation Safety at State Level. *Reliability Engineering & System Safety*, 179(1), pp. 74-82, DOI: 10.1016/j.ress.2016.12.002.
- [123] Insua, D. R., Alfaro, C., Gomez, J., Hernandez-Coronado, P. & Bernal, F., 2019. Forecasting and Assessing Consequences of Aviation Safety Occurrences. *Safety Science*, 111(1), pp. 243-252, DOI: 10.1016/j.ssci.2018.07.018.
- [124] Ioannou, C., Harris, D. & Dahlstrom, N., 2017. Safety Management Practices Hindering the Development of Safety Performance Indicators in Aviation Service Providers. *Aviation Psychology and Applied Human Factors*, 7(2), pp. 95-106, DOI: 10.1027/2192-0923/a000118.
- [125] ITF, 2018. *Safety Management Systems*, Paris: OECD Publishing.
- [126] Jakovljević, I., Čokorilo, O., Dell-Acqua, G. & Mirosavljević, P., 2017. Aircraft Departure Control Systems-Hidden Safety Risks. *International Journal for Traffic and Transport Engineering (IJTTE)*, 7(3), pp. 298-311, DOI: 10.7708/ijtte.2017.7(3).02.
- [127] Kambadur, P., Lozano, A. C. & Luss, R., 2016. Temporal Causal Modeling. In: *Financial Signal Processing and Machine Learning*. Hoboken, NJ: Wiley-IEEE Press, pp. 41-66.
- [128] Kaspers, S., Karanikas, N., Piric, S., van Aalst, R., De Boer, R. J. & Roelen, A. L. C., 2017. Measuring Safety in Aviation: Empirical Results about the Relation between Safety Outcomes and Safety Management System Processes, Operational Activities and Demographic Data. Venice, The Seventh International Conference on Performance, Safety and Robustness in Complex Systems and Applications (PESARO 2017), 23-27 April 2017.
- [129] Kaspers, S., Karanikas, N., Roelen, A. L. C., Piric, S. & De Boer, R. J., 2019. How Does Aviation Industry Measure Safety Performance? Current Practice and Limitations. *International Journal of Aviation Management*, 4(3), pp. 224-245, DOI: 10.1504/IJAM.2019.10019874.
- [130] Kaspers, S., Karanikas, N., Roelen, A. L. C., Piric, S., van Aalst, R. & De Boer, R. J., 2016. Exploring the Diversity in Safety Measurement Practices: Empirical Results from Aviation. *Journal of Safety Studies*, 2(2), pp. 18-29, DOI: 10.5296/jss.v2i2.10437.
- [131] Kelly, D. & Smith, C., 2011. *Bayesian Inference for Probabilistic Risk Assessment: A Practitioner's Guidebook*. London: Springer.
- [132] Khakzada, N., Khan, F. & Amyotte, P., 2013. Dynamic Safety Analysis of Process Systems by Mapping Bow-Tie into Bayesian Network. *Process Safety and Environmental Protection*, 91(1-2), pp. 46-53, DOI: 10.1016/j.psep.2012.01.005.
- [133] Khoshkhoo, R., 2017. Adaptation of Line Operations Safety Audit (LOSA) to Dispatch Operations (DOSAs). *Journal of Airline and Airport Management*, 7(2), pp. 65-74, DOI: 10.3926/jairm.112.

- [134] Kinnersley, S. & Roelen, A. L. C., 2007. The Contribution of Design to Accidents. *Safety Science*, 45(1-2), pp. 31-60, DOI: 10.1016/j.ssci.2006.08.010.
- [135] Kjaerulff, U. B. & Madsen, A. L., 2008. *Bayesian Networks and Influence Diagrams: A Guide to Construction and Analysis*. New York, NY: Springer.
- [136] Koller, D. & Friedman, N., 2009. *Probabilistic Graphical Models: Principles and Techniques*. Cambridge, MA: MIT Press.
- [137] Kraus, J., Lališ, A., Plos, V., Vittek, P. & Stojić, S., 2018. Utilizing Ontologies and Structural Conceptual Models for Safety Data Management in Aviation Maintenance, Repair and Overhaul Organizations. *Transportation Research Procedia*, 35(1), pp. 35-43, DOI: 10.1016/j.trpro.2018.12.005.
- [138] Krueger, J. I., 2020. Prediction and Explanation in a Postmodern World. *Frontiers in Psychology*, 11(1), pp. 1-14, DOI: 10.3389/fpsyg.2020.597706.
- [139] Küçükönala, H. & Sedefoğlu, G., 2017. The Causality Analysis of Air Transport and Socio-Economics Factors: The Case of OECD Countries. *Transportation Research Procedia*, 28(1), pp. 16-26, DOI: 10.1016/j.trpro.2017.12.164.
- [140] Kurowicka, D. & Cooke, R., 2006. *Uncertainty Analysis with High Dimensional Dependence Modelling*. West Sussex: Wiley.
- [141] Kurt, Y. & Gerege, E., 2018. An Assessment of Aviation Safety Management System Applications from the New Institutional Theory Perspective. *International Journal of Management Economics and Business*, 14(1), pp. 97-122, DOI: 10.17130/ijmeb.2018137576.
- [142] Lališ, A., Socha, V., Kraus, J., Nagy, I. & Licu, A., 2018. Conditional and Unconditional Safety Performance Forecasts for Aviation Predictive Risk Management. IEEE, 2018 IEEE Aerospace Conference, pp. 1-8.
- [143] Lališ, A. & Vittek, P., 2014. Safety KPIs – Monitoring of Safety Performance. *Magazine of Aviation Development [MAD]*, 2(11), pp. 9-12, DOI: 10.14311/MAD.2014.11.02.
- [144] Laubach, Z. M., Murray, E. J., Hoke, K. L., Safran, R. J. & Perng, W., 2021. A Biologist's Guide to Model Selection and Causal Inference. RSPB, Proceedings B of the Royal Society Publishing, pp. 1-8, DOI: 10.1098/rspb.2020.2815.
- [145] Lawson, A. E., 2008. What Are Null Hypotheses? The Reasoning Linking Scientific and Statistical Hypothesis Testing. *The Science Education Review*, 7(3), pp. 106-112.
- [146] Lawson, A. E., 2009. Basic Inferences of Scientific Reasoning, Argumentation, and Discovery. *Science Education*, 94(1), pp. 336-364, DOI: 10.1002/sce.20357.
- [147] Lechner, K. W. & Luxhøj, J. T., 2005. Probabilistic Causal Modeling of Risk Factors Contributing to Runway Collisions: Case Studies. *Human Factors and Aerospace Safety*, 5(3), pp. 185-215.



- [148] Leech, N. L., Barrett, K. C. & Morgan, G. A., 2008. *SPSS for Intermediate Statistics: Use and Interpretation, 3rd Edition*. New York, NY: Taylor & Francis.
- [149] Lee, J. & Chung, H., 2018. A New Methodology for Accident Analysis with Human and System Interaction Based on FRAM: Case Studies in Maritime Domain. *Safety Science*, 109(1), pp. 57-66, DOI: 10.1016/j.ssci.2018.05.011.
- [150] Lehto, M. R. & Salvendy, G., 1991. Models of Accident Causation and Their Application: Review and Reappraisal. *Journal of Engineering and Technology Management*, 8(2), pp. 173-205, DOI: 10.1016/0923-4748(91)90028-P.
- [151] Lenne, M. G., Salmon, P. M., Liu, C. C. & Trotter, M., 2012. A Systems Approach to Accident Causation in Mining: An Application of the HFACS Method. *Accident Analysis and Prevention*, 48(1), pp. 111-117, DOI: 10.1016/j.aap.2011.05.026.
- [152] Leveson, N., 2015. A Systems Approach to Risk Management through Leading Safety Indicators. *Reliability Engineering & System Safety*, 136(1), pp. 17-34, DOI: 10.1016/j.ress.2014.10.008.
- [153] Leveson, N., 2017. Rasmussen's Legacy: A Paradigm Change in Engineering for Safety. *Applied Ergonomics*, 59(Part B), pp. 581-591, DOI: 10.1016/j.apergo.2016.01.015.
- [154] Liou, J. J. H., Yen, L. & Tzeng, G. H., 2008. Building an Effective Safety Management System for Airlines. *Journal of Air Transport Management*, 14(1), pp. 20-26, DOI: 10.1016/j.jairtraman.2007.10.002.
- [155] Li, W., Zhang, L. & Liang, W., 2017. An Accident Causation Analysis and Taxonomy (ACAT) Model of Complex Industrial System from Both System Safety and Control Theory Perspectives. *Safety Science*, 92(1), pp. 94-103, DOI: 10.1016/j.ssci.2016.10.001.
- [156] Longworth, F., 2006. Causation, Pluralism and Responsibility. *Philosophica*, 77(1), pp. 45-68.
- [157] Lu, C.-T., Wetmore, M. & Przetak, R., 2006. Another Approach to Enhance Airline Safety: Using Management Safety Tools. *Journal of Air Transportation*, 11(2), pp. 113-139.
- [158] Luxhøj, J. T., 2003. Probabilistic Causal Analysis for System Safety Risk Assessments in Commercial Air Transport. Williamsburg, VA, Proceedings of the Workshop on Investigating and Reporting of Incidents and Accidents (IRIA), 16-19 September, pp. 17-38.
- [159] Luxhøj, J. T., 2013. Predictive Safety Analytics for Complex Aerospace Systems. *Procedia Computer Science*, 20(1), pp. 331-336, DOI: 10.1016/j.procs.2013.09.281.
- [160] Luxhøj, J. T. & Coit, D. W., 2006. *Modeling Low Probability/High Consequence Events: An Aviation Safety Risk Model*. Piscataway, NJ, Reliability and Maintainability Symposium.

- [161] Luxhøj, J. T., Jalil, M. & Jones, S. M., 2003. A Risk-Based Decision Support Tool for Evaluating Aviation Technology Integration in the National Airspace System. Denver, CO, Proceedings of the AIAA's 3rd Annual Aviation Technology, Integration, and Operations (ATIO) Technical Forum, 17-19 November 2003.
- [162] Maeng, J. & Bell, R., 2013. Theories, Laws, and Hypotheses. *The Science Teacher*, 80(7), pp. 38-43, DOI: 10.2505/4/tst13\_080\_07\_38.
- [163] Maurino, D. E., 1999. *Human Error in Aviation Maintenance: The Years to Come*. Washington, DC: FAA.
- [164] McDonald, N., Corrigan, S., Ulfvengren, P. & Baranzini, D., 2014. Proactive Safety Performance for Aviation Operations. Cambridge, International Conference on Engineering Psychology and Cognitive Ergonomics (EPCE 2014), pp. 351-362.
- [165] McIntyre, G. R., 2002. The Application of System Safety Engineering and Management Techniques at the US Federal Aviation Administration (FAA). *Safety Science*, 40(1-4), pp. 325-335, DOI: 10.1016/S0925-7535(01)00052-2.
- [166] Mirosavljević, P., Čokorilo, O. & Gvozdenović, S., 2008. Performance Monitoring in Transport Aircraft Flight Operations. [*Technique-Traffic*], 55(5), pp. 5-10.
- [167] Mosleh, A., Dias, A., Eghbali, G. & Fazen, K., 2004. *An Integrated Framework for Identification, Classification, and Assessment of Aviation Systems Hazards*. In: *Probabilistic Safety Assessment and Management*. London: Springer.
- [168] Müller, R., Wittmer, A. & Drax, C., 2014. *Aviation Risk and Safety Management: Methods and Applications in Aviation Organizations*. Cambridge: Springer.
- [169] Munteanu, I. & Aldemir, T., 2003. A Methodology for Probabilistic Accident Management. *Nuclear Technology*, 144(1), pp. 49-62, DOI: 10.13182/NT03-A3428.
- [170] Nagel, S., 2006. *Effects of Organisation on Safety: „Changing with the Times”*. Wichita, KS, The Bombardier Safety Standdown on Business Aviation Accident Prevention.
- [171] NASA, 2002. *Probabilistic Risk Assessment Procedures Guide for NASA Managers and Practitioners*. Washington, DC: National Aeronautics and Space Administration.
- [172] NavBlue, 2020. Flight Data Analysis, Online: <https://www.navblue.aero/product/flight-data-analysis-suite/> [19 August 2020].
- [173] Nazeri, Z., Bloedorn, E. & Ostwald, P., 2001. Experiences in Mining Aviation Safety Data. SIGMOD 2001, Proceedings of the 2001 ACM SIGMOD International Conference on Management of Data, pp. 562-566.
- [174] Netjasov, F. & Janic, M., 2008. A Review of Research on Risk and Safety Modelling in Civil Aviation. *Journal of Air Transport Management*, 14(4), pp. 213-220, DOI: 10.1016/j.jairtraman.2008.04.008.

- [175] O'Conner, P., O'Dea, A., Kennedy, Q. & Buttrey, S. E., 2011. Measuring Safety Climate in Aviation: A Review and Recommendations for the Future. *Safety Science*, 49(2), pp. 128-138, DOI: 10.1016/j.ssci.2010.10.001.
- [176] Onyegiri, I. E. & Oke, S. A., 2017. A Grey Relational Analytical Approach to Safety Performance Assessment in an Aviation Industry of a Developing Country. *Engineering and Applied Science Research*, 44(1), pp. 1-15, DOI: 10.14456/easr.2017.1.
- [177] Oster Jr., C. V., Strong, J. S. & Zorn, K., 2013. Analyzing Aviation Safety: Problems, Challenges, Opportunities. *Research in Transportation Economics*, 43(1), pp. 148–164, DOI: 10.1016/j.retrec.2012.12.001.
- [178] Ostrowski, K. A., Valha, D. & Ostrowski, K. E., 2014. USAF Aviation Safety Program Gap Analysis Using ICAO Safety Management Guidance. *Professional Safety*, 59(7), pp. 26-32.
- [179] Otexs, 2022. Autoregressive models, Online: <https://otexs.com/fpp2/AR.html> [19 January 2022]
- [180] Ozan Ceylan, B., Akyuz, E. & Arslanoğlu, Y., 2022. Modified Quantitative Systems Theoretic Accident Model and Processes (STAMP) Analysis: A Catastrophic Ship Engine Failure Case. *Ocean Engineering*, 253(8), pp. 111187, DOI: 10.1016/j.oceaneng.2022.111187.
- [181] Pacheco, R. R. & Fernandes, E., 2017. International Air Passenger Traffic, Trade Openness and Exchange Rate in Brazil: A Granger Causality Test. *Transportation Research Part A: Policy and Practice*, 101(1), pp. 22–29, DOI: 10.1016/j.tra.2017.04.026.
- [182] Panagopoulos, I., 2011. Flight Safety in Combat Training: A Revised Pilot's Error Framework for EU Air Forces. London, Hellenic Observatory: 5th Biennial Hellenic Observatory PhD Symposium.
- [183] Panagopoulos, I., Atkin, C. & Sikora, I., 2017. Developing a Performance Indicators Lean-Sigma Framework for Measuring Aviation System's Safety Performance. *Transportation Research Procedia*, 22(1), pp. 35-44, DOI: 10.1016/j.trpro.2017.03.005.
- [184] Pasman, H. J., Rogers, W. J. & Mannan, M. S., 2018. How Can We Improve Process Hazard Identification? What Can Accident Investigation Methods Contribute and What Other Recent Developments? A Brief Historical Survey and a Sketch of How to Advance. *Journal of Loss Prevention in the Process Industries*, 55(1), pp. 80-106, DOI: 10.1016/j.jlp.2018.05.018.
- [185] Patankar, M. S. & Taylor, J. C., 2004. *Risk Management and Error Reduction in Aviation*. Aldershot: Ashgate.
- [186] Patriarca, R., Di Gravio, G., Cioponea, R. & Licu, A., 2019. Safety Intelligence: Incremental Proactive Risk Management for Holistic Aviation Safety Performance. *Safety Science*, 118(1), pp. 551-567, DOI: 10.1016/j.ssci.2019.05.040.

- [187] Patriarca, R., Di Gravio, G. & Costantino, F., 2017. A Monte Carlo Evolution of the Functional Resonance Analysis Method (FRAM) to Assess Performance Variability in Complex Systems. *Safety Science*, 91(1), pp. 49-60, DOI: 10.1016/j.ssci.2016.07.016.
- [188] Patriarca, R., Di Gravio, G., G., Woltjer, R., Costantino, F., Praetorius, G., Ferreira, P. & Hollnagel, E., 2020. Framing the FRAM: A Literature Review on the Functional Resonance Analysis Method. *Safety Science*, 129(1), pp. 1-23, DOI: 10.1016/j.ssci.2020.104827.
- [189] Pearl, J., 2009. *Causality: Models, Reasoning, and Inference, 2nd Edition*. New York, NY: Cambridge University Press.
- [190] Pearl, J. & Mackenzie, D., 2018. *The Book of Why: The New Science of Cause and Effect*. New York, NY: Basic Books.
- [191] Peters, J., Bühlmann, P. & Meinshausen, N., 2016. Causal Inference Using Invariant Prediction: Identification and Confidence Intervals. *Journal of the Royal Statistical Society. Series B (Statistical Methodology)*, 78(5), pp. 947-1012.
- [192] Peters, J., Janzing, D. & Schölkopf, B., 2017. *Elements of Causal Inference: Foundations and Learning Algorithms*. Cambridge: MIT Press.
- [193] Pisanich, G. M. & Corker, K., 1995. A Predictive Model of Flight Crew Performance in Automated Air Traffic Control and Flight Management Operations. Columbus, Ohio State 8th International Symposium on Aviation Psychology.
- [194] Ramspek, C. L., Steyerberg, E. W., Riley, R. D., Rosendaal, F. R., Dekkers, O. M., Dekker, F. W. & van Diepen, M. 2021. Prediction or Causality? A Scoping Review of Their Confation Within Current Observational Research. *European Journal of Epidemiology*, 36(1), pp. 889-898, DOI: 10.1007/s10654-021-00794-w.
- [195] Rashid, H. S. J., Place, C. S. & Braithwaite, G. R., 2013. Investigating the Investigations: A Retrospective Study in the Aviation Maintenance Error Causation. *Cognition, Technology & Work*, 15(1), pp. 171-188, DOI: 10.1007/s10111-011-0210-7.
- [196] Rasmussen, J., 1997. Risk Management in a Dynamic Society: A Modelling Problem. *Safety Science*, 27(2-3), pp. 183-213, DOI: 10.1016/S0925-7535(97)00052-0.
- [197] Rasmussen, J. & Svedung, I., 2000. *Proactive Risk Management in a Dynamic Society*. Sweden: Swedish Rescue Services Agency.
- [198] Rathnayaka, S., Khan, F. & Amyotte, P., 2011. SHIPP Methodology: Predictive Accident Modeling Approach, Part II. Validation with Case Study. *Process Safety and Environmental Protection*, 89(2), pp. 75-88, DOI: 10.1016/j.psep.2010.12.002.
- [199] Reason, J., 1990. *Human Error*. New York, NY: Cambridge University Press.
- [200] Reason, J., 1991. Identifying the Latent Causes of Aircraft Accidents Before and after the Event. Sterling, Proceedings of the 22nd Seminar of the International Society of Air Accident Investigators, pp. 39-46.

- [201] Reason, J., 1995. A Systems Approach to Organizational Error. *Ergonomics*, 38(8), pp. 1708-1721, DOI: 10.1080/00140139508925221.
- [202] Reason, J., 1997. *Managing the Risks of Organizational Accidents*. London: Routledge.
- [203] Reason, J., 2008. *The Human Contribution: Unsafe Acts, Accidents and Heroic Recoveries*. Aldershot: Ashgate.
- [204] Reiss, J., 2009. Causation in the Social Sciences: Evidence, Inference, Purpose. *Philosophy of the Social Sciences*, 39(1), pp. 20-40, DOI: 10.1177/0048393108328150.
- [205] Reiss, J., 2012. Causation in the Sciences: An Inferentialist Account. *Studies in History and Philosophy of Science, Part C: Studies in History and Philosophy of Biological and Biomedical Sciences*, 43(4), pp. 769-777, DOI: 10.1016/j.shpsc.2012.05.005.
- [206] Rezaei, M. & Borjalilu, N., 2018. A Dynamic Risk Assessment Modeling Based on Fuzzy ANP for Safety Management Systems. *Aviation*, 22(4), pp. 143-155, DOI: 10.3846/aviation.2018.6983.
- [207] Roberts, K. H. & Bea, R., 2001. Most Accidents Happen? Lessons from High-Reliability Organisations. *Academy of Management Perspectives*, 15(3), pp. 70-79, DOI: 10.5465/AME.2001.5229613.
- [208] Robinson, S. D., 2019. Temporal Topic Modeling Applied to Aviation Safety Reports: A Subject Matter Expert Review. *Safety Science*, 116(1), pp. 275-286, DOI: 10.1016/j.ssci.2019.03.014.
- [209] Roelen, A. L. C., 2008. *Causal Risk Models of Air Transport: Comparison of User Needs and Model Capabilities*. Amsterdam: IOS Press.
- [210] Roelen, A. L. C. & Klompstra, M. B., 2012. The Challenges in Defining Aviation Safety Performance Indicators. Helsinki, PSAM 11 & ESREL 2012, 25-29 June.
- [211] Roelen, A. L. C., Lin, P. H. & Hale, A. R., 2011. Accident Models and Organisational Factors in Air Transport: The Need for Multi-Method Models. *Safety Science*, 49(1), pp. 5-10, DOI: 10.1016/j.ssci.2010.01.022.
- [212] Roelen, A. L. C., Verstraeten, J. G., Speijker, L. J. P., Munoz, S. B., Heckmann, J. P., Save, L. & Longhurst, T., 2016. Risk Models and Accident Scenarios in the Total Aviation System, Online: [https://ascos-project.eu/downloads/ascos\\_paper\\_roelen.pdf](https://ascos-project.eu/downloads/ascos_paper_roelen.pdf) [28 May 2020].
- [213] Rohrer, J. M., 2018. Thinking Clearly about Correlations and Causation: Graphical Causal Models for Observational Data. *Advances in Methods and Practices in Psychological Science*, 1(1), pp. 27-42, DOI: 10.1177/2515245917745629.
- [214] Rose, R. L., Puranik, T. G., Mavris, D. N. & Rao, A. H., 2022. Application of Structural Topic Modeling to Aviation Safety Data. *Reliability Engineering & System Safety*, 224(1), pp. 108522, DOI: 10.1016/j.ress.2022.108522.

- [215] Salmon, P. M., Cornelissen, M. & Trotter, M. J., 2012. Systems-Based Accident Analysis Methods: A comparison of Accimap, HFACS, and STAMP. *Safety Science*, 50(4), pp. 1158-1170, DOI: 10.1016/j.ssci.2011.11.009.
- [216] Salmon, P. M., Williamson, A., Lenne, M. G. & Mitsopoulos, E.; Rudin-Brown, C. M., 2010. Systems-Based Accident Analysis in the Led Outdoor Activity Domain: Application and Evaluation of a Risk Management Framework. *Ergonomics*, 53(8), pp. 927-939, DOI: 10.1080/00140139.2010.489966.
- [217] Sarasvathy, S. D., 2001. Causation and Effectuation: Toward a Theoretical Shift from Economic Inevitability to Entrepreneurial Contingency. *The Academy of Management Review*, 26(2), pp. 243-263, DOI: 10.5465/AMR.2001.4378020.
- [218] Sarter, N. B. & Alexander, H. M., 2000. Error Types and Related Error Detection Mechanisms in the Aviation Domain: An Analysis of Aviation Safety Reporting System Incident Reports. *The International Journal of Aviation Psychology*, 10(2), pp. 189-206, DOI: 10.1207/S15327108IJAP1002\_5.
- [219] Senders, J. W. & Moray, N. P., 1991. *Human Error Cause Prediction and Reduction*. Hillsdale: Lawrence Erlbaum.
- [220] Shappell, S., Detwiler, C., Holcomb, K., Hackworth, C., Boquet, A. & Wiegmann, D. A., 2009. *Human Error and Commercial Aviation Accidents: An Analysis Using the Human Factors Analysis and Classification System*. In: *Human Error in Aviation*. London: Routledge.
- [221] Shi, D., Guan, J., Zurada, J. & Manikas, A., 2017. A Data-Mining Approach to Identification of Risk Factors in Safety Management Systems. *Journal of Management Information Systems*, 34(4), pp. 1054-1081, DOI: 10.1080/07421222.2017.1394056.
- [222] Shih, A. T., Ancel, E. & Jones, S. M., 2012. Object-Oriented Bayesian Networks (OOBN) for Aviation Accident Modeling and Technology Portfolio Impact Assessment. Virginia Beach, Proceedings of the American Society for Engineering Management (ASEM), 33rd International Annual Conference, October 17-20.
- [223] Shmueli, G., 2010. To Explain or to Predict? *Statistical Science*, 25(3), pp. 289-310, DOI: 10.1214/10-STS330.
- [224] Singh, V., Kumar Sharma, S., Chadha, I. & Singh, T., 2019. Investigating the Moderating Effects of Multi-Group on Safety. *Case Studies on Transport Policy*, 7(2), pp. 477-488, DOI: 10.1016/j.cstp.2019.01.002.
- [225] Sloman, S. A., 2005. *Causal Models: How We Think about the World and Its Alternatives*. New York, NY: Oxford University Press.
- [226] Snook, S. A., 2000. *Practical Drift: Friendly Fire, The Accidental Shootdown Of U.S. Black Hawks Over Northern Iraq*. New Jersey, NJ: Princetown University Press.

- [227] Spirtes, P., Glymour, C. & Scheines, R., 2000. *Causation, Prediction, and Search, 2nd Edition*. Cambridge: MIT Press.
- [228] Split Airport, 2022. Internal Safety Performance Management (SPIs) Reports & Data 2014-2021, Split: Split Airport.
- [229] Stanton, N., Salmon, P., Harris, D., Marshall, A., Demagalski, J., Young, M., Waldmann, T. & Dekker, S., 2008. Predicting Pilot Error: Testing a New Methodology and a Multi-Methods and Analysts Approach. *Applied Ergonomics*, 40(1), pp. 464-471, DOI: 10.1016/j.apergo.2008.10.005.
- [230] Steiner, S., 1998. [*Elements of Air Traffic Safety*]. Zagreb: Faculty of Transport and Traffic Sciences.
- [231] Steiner, S., Fakleš, D. & Bartulović, D., 2018. Methodological Approach to Fatigue Risk Mitigation in Flight Operations. Belgrade, Proceedings of the Fourth International Conference on Traffic and Transport Technology (ICTTE 2018), pp. 14-21.
- [232] Steiner, S., Galović, B. & Radačić, Ž., 1998. Concept of Air Traffic Safety Program in Croatia. *Promet-Traffic-Traffico*, 10(5-6), pp. 251-256.
- [233] Steiner, S., Štimac, I., & Melvan, M., 2014. Towards to Collaborative Air Traffic and Airport Management, Proceedings of the 22nd International Symposium on Electronics in Transport (ISEP 2014), Ljubljana.
- [234] Stemn, E., Bofinger, C., Cliff, D. & Hassall, M. E., 2018. Failure to Learn from Safety Incidents: Status, Challenges and Opportunities. *Safety Science*, 101(1), pp. 313-325, DOI: 10.1016/j.ssci.2017.09.018.
- [235] Stolzer, A. J. & Goglia, J. J., 2015. *Safety Management Systems in Aviation, 2nd Edition*. Farnham: Ashgate.
- [236] Sun, H., Wang, C., Li, Q. & Zhang, B., 2021. Research on ICAO Safety Performance Monitoring Algorithm. Changsha, 2021 IEEE 3rd International Conference on Civil Aviation Safety and Information Technology (ICCASIT), 20-22 October 2021, pp. 190-193.
- [237] Sun, Y., Zhang, Y., Zhao, R. & Chen, Y., 2018. Safety Performance Evaluation for Civil Aviation Maintenance Department. DHM 2018, International Conference on Digital Human Modeling and Applications in Health, Safety, Ergonomics and Risk Management, pp. 635-646.
- [238] Svedung, I. & Rasmussen, J., 2002. Graphic Representation of Accident Scenarios: Mapping System Structure and the Causation of Accidents. *Safety Science*, 40(5), pp. 397-417, DOI: 10.1016/S0925-7535(00)00036-9.
- [239] Škurla Babić, R., 2011. Comparison of Air Travel Demand Forecasting Methods. Portorož: Slovene Association of Transport Sciences: 14th International Conference on Transport Science, 27 May 2011.

- [240] Uyar, T., 2019. Structuring Risk Assessment Process with Tallying in Aviation Safety Management. *The International Journal of Aerospace Psychology*, 29(3-4), pp. 65-73, DOI: 10.1080/24721840.2019.1621176.
- [241] Valdés, R. M. A., Comendador, F. G., Gordún, L. M. & Nieto, F. J. S., 2011. The Development of Probabilistic Models to Estimate Accident Risk (Due to Runway Overrun and Landing Undershoot) Applicable to the Design and Construction of Runway Safety Areas. *Safety Science*, 49(5), pp. 633-650, DOI: 10.1016/j.ssci.2010.09.020.
- [242] Valdez Banda, O. A. & Goerlandt, F., 2018. A STAMP-Based Approach for Designing Maritime Safety Management Systems. *Safety Science*, 109(1), pp. 109-129, DOI: 10.1016/j.ssci.2018.05.003.
- [243] Van De Vijver, E., Derudder, B. & Witlox, F., 2014. Exploring Causality in Trade and Air Passenger Travel Relationships: The Case of Asia-Pacific, 1980-2010. *Journal of Transport Geography*, 34(1), pp. 142-150, DOI: 10.1016/j.jtrangeo.2013.12.001.
- [244] Vanderhaegen, F., 2010. Human-Error-Based Design of Barriers and Analysis of Their Uses. *Cognition, Technology & Work*, 12(1), pp. 133-142, DOI: 10.1007/s10111-010-0146-3.
- [245] Velazquez, J. & Bier, N., 2015. SMS and CRM: Parallels and Opposites in their Evolution. *Journal of Aviation/Aerospace Education & Research*, 24(2).
- [246] Vileiniskis, M. & Remenyte-Prescott, R., 2017. Quantitative Risk Prognostics Framework Based on Petri Net and Bow-Tie Models. *Reliability Engineering & System Safety*, 165(1), pp. 62-73, DOI: 10.1016/j.ress.2017.03.026.
- [247] Villa, V. & Cozzani, V., 2016. Application of Bayesian Networks to Quantitative Assessment of Safety Barriers' Performance in the Prevention of Major Accidents. *Chemical Engineering Transactions*, 53(1), pp. 151-156, DOI: 10.3303/CET1653026.
- [248] Wang, B., Wu, C., Shi, B. & Huang, L., 2017. Evidence-Based Safety (EBS) Management: A New Approach to Teaching the Practice of Safety Management (SM). *Journal of Safety Research*, 63(1), pp. 21-28, DOI: 10.1016/j.jsr.2017.08.012.
- [249] Wang, Y. F., Xie, M., Chin, K. & Fu, X. J., 2013. Accident Analysis Model Based on Bayesian Network and Evidential Reasoning Approach. *Journal of Loss Prevention in the Process Industries*, 26(1), pp. 10-21, DOI: 10.1016/j.jlp.2012.08.001.
- [250] Wiedermann, W. & Von Eye, A., 2016. *Statistics and Causality*. Hoboken, NJ: John Wiley & Sons.
- [251] Wiegmann, D. A. & Shappell, S. A., 2001. Human Error Perspectives in Aviation. *The International Journal of Aviation Psychology*, 11(4), pp. 341-357, DOI: 10.1207/S15327108IJAP1104\_2.
- [252] Wiegmann, D. A. & Shappell, S. A., 2003. *A Human Error Approach to Aviation Accident Analysis*. Aldershot: Ashgate Publishing.



- [253] Wilke, S., Majumdar, A. & Ochieng, W. Y., 2014. A Framework for Assessing the Quality of Aviation Safety Databases. *Safety Science*, 63(1), pp. 133-145, DOI: 10.1016/j.ssci.2013.11.005.
- [254] Wolfers, J. & Zitzewitz, E., 2004. Prediction Markets. *Journal of Economic Perspectives*, 18(2), pp. 107-126, DOI: 10.1257/0895330041371321.
- [255] Wood, R., 2003. *Aviation Safety Programs, A Management Handbook, 3rd Edition*. Englewood, CO: Jeppesen-Sanderson.
- [256] Wu, J. S., Apostolakis, G. & Okrent, D., 1990. Uncertainties in System Analysis: Probabilistic versus Nonprobabilistic Theories. *Reliability Engineering & System Safety*, 30(1-3), pp. 163-181, DOI: 10.1016/0951-8320(90)90093-3.
- [257] X, 2020. Internal Safety Management Reports 2014-2019, Zagreb: X.
- [258] Xu, S., Chan, H.K. & Zhang, T., 2019. Forecasting the Demand of the Aviation Industry Using Hybrid Time Series SARIMA-SVR Approach. *Transportation Research Part E: Logistics and Transportation Review*, 122(1), pp. 169-180, DOI: 10.1016/j.tre.2018.12.005.
- [259] Xuecai, X., Gui, F., Yujingyang, X., Ziqi, Z., Ping, C., Baojun, L. & Song, J., 2019. Risk Prediction and Factors Risk Analysis Based on IFOA-GRNN and Apriori Algorithms: Application of Artificial Intelligence in Accident Prevention. *Process Safety and Environmental Protection*, 122(1), pp. 169-184, DOI: 10.1016/j.psep.2018.11.019.
- [260] Y, 2021. Internal Safety and Compliance Monitoring Management Reports 2014-2020, Zagreb: Y.
- [261] Yarkoni, T. & Westfall, J., 2017. Choosing Prediction over Explanation in Psychology: Lessons from Machine Learning. *Perspectives on Psychological Science*, 12(6), pp. 1100-1122, DOI: 10.1177/1745691617693393.
- [262] Yeun, R., Bates, P. & Murray, P., 2014. Aviation Safety Management Systems. *World Review of Intermodal Transportation Research*, 5(2), pp. 168-196, DOI: 10.1504/WRITR.2014.067234.
- [263] Yousefi, A., Rodriguez Hernandez, M. & Lopez Peña, V., 2018. Systemic Accident Analysis Models: A Comparison Study Between AcciMap, FRAM, and STAMP. *Process Safety Progress*, 38(2), pp. 1-16, DOI: 10.1002/prs.12002.
- [264] Yuingyang, X. & Gui, F., 2018. A Modified Accident Analysis and Investigation Model for the General Aviation Industry: Emphasizing on Human and Organizational Factors. *Journal of Safety Research*, 67(1), pp. 1-15, DOI: 10.1016/j.jsr.2018.09.008.
- [265] Zhang, Y., Dong, C., Guo, W., Dai, J. & Zhao, Z., 2022. Systems Theoretic Accident Model and Process (STAMP): A Literature Review. *Safety Science*, 152(1), pp. 105596, DOI: 10.1016/j.ssci.2021.105596.

- [266] Zheqi, Z., Ren, B., Xiaofeng, Z., Hang, Z., Tao, X. & Qingge, C., 2020. Neural Network-Based Probability Forecasting Method of Aviation Safety. Shaanxi, IOP Publishing Ltd: IOP Conference Series: Materials Science and Engineering, Volume 1043, The 10th International Conference on Quality, Reliability, Risk, Maintenance, and Safety Engineering (QR2MSE 2020), 8-11 October 2020.
- [267] Zhou, J. & Lei, Y., 2017. Paths between Latent and Active Errors: Analysis of 407 Railway Accidents/Incidents' Causes in China. *Safety Science*, 110(B), pp. 47-58, DOI: 10.1016/j.ssci.2017.12.027.
- [268] Zikrullah, N. A., Kim, H., van der Meulen, M. J. P., Skofteland, G. & Lundteigen, M. A., 2021. A Comparison of Hazard Analysis Methods Capability for Safety Requirements Generation. *Proceedings of the Institution of Mechanical Engineers, Part O: Journal of Risk and Reliability*, 235(6), pp. 1132-1153, DOI: 10.1177/1748006X211003463.

## LIST OF TABLES

Table 1 Safety risk probability table .....	30
Table 2 Safety risk severity table .....	31
Table 3 Safety risk assessment matrix .....	32
Table 4 Safety risk tolerability .....	33
Table 5 Sources of safety data and safety information .....	41
Table 6 Examples of safety objectives .....	52
Table 7 Statistical data on number of flights at Franjo Tuđman Airport for period from December 2017 to February 2022 .....	70
Table 8 Example of descriptive statistics .....	71
Table 9 Examples of tests of normality .....	74
Table 10 Statistical data of Franjo Tuđman Airport for period 2017-2022 .....	87
Table 11 Forecasts of indicators at Franjo Tuđman Airport for period 2022-2025 .....	89
Table 12 Example of data (fictional) on recorded demand .....	94
Table 13 Calculation of demand parameters using I1 method.....	95
Table 14 Calculation of demand parameters using I2 method.....	95
Table 15 Calculation of demand parameters using RWA method .....	96
Table 16 Calculation of demand parameters using RWM method .....	97
Table 17 Calculation of demand parameters using RWP75 method .....	98
Table 18 Calculation of demand parameters using BP method .....	98
Table 19 Calculation of demand parameters using EM method.....	101
Table 20 Calculation of the values of the probability density function and the probability distribution function (for demand parameters obtained using the EM method) .....	101
Table 21 Calculation of demand parameters using PD method .....	105
Table 22 Calculation of the values of the probability density function and the probability distribution function (for demand parameters obtained using the PD method) .....	105
Table 23 Selected predictive methods applicable in aviation safety management.....	108
Table 24 Safety data and safety performance indicators (SPIs) database in the period 2014- 2019.....	113
Table 25 Total number of reported occurrences (hazards) – Forecast till 2024.....	118
Table 26 Number of hazards (MOR) – Forecast till 2024.....	119
Table 27 Number of conducted risk assessments & risk mitigations – Forecast till 2024 .....	120
Table 28 Number of Safety Review Boards (SRBs) – Forecast till 2024.....	121
Table 29 Number of reported occurrences vs. number of flight hours – Forecast till 2024...	122
Table 30 List of organisational and safety performance indicators in observed dataset .....	136
Table 31 Dataset of organisational indicators (OIs) and safety performance indicators (SPIs) .....	137
Table 32 Statistics of each indicator of observed dataset.....	140
Table 33 Tests of normality.....	141
Table 34 Initial forecast model description and statistics .....	144
Table 35 Initial forecast of safety performance indicators .....	145
Table 36 Fit statistics for top causal models.....	149
Table 37 Number of passengers at Split Airport in the period from 1966 to 2021.....	164
Table 38 List of organisational and safety performance indicators in observed dataset at the Split Airport.....	165

Table 39 Dataset of organisational indicators (OIs) and safety performance indicators (SPIs) at the Split Airport.....	167
Table 40 Dataset of achieved safety performance targets (SPTs) at the Split Airport.....	168
Table 41 Fit statistics for top causal models.....	172
Table 42 Outlier root cause analysis for indicator OI1 .....	179
Table 43 Outlier root cause analysis for indicator SPI1 .....	180
Table 44 Outlier root cause analysis for indicator SPI2 .....	180
Table 45 Outlier root cause analysis for indicator SPI3 .....	181
Table 46 Outlier root cause analysis for indicator SPI4 .....	182
Table 47 Outlier root cause analysis for indicator SPI5 .....	183
Table 48 Outlier root cause analysis for indicator SPI7 .....	184
Table 49 Outlier root cause analysis for indicator SPI8 .....	185
Table 50 Outlier root cause analysis for indicator SPI9 .....	185
Table 51 Outlier root cause analysis for indicator SPI10 .....	186
Table 52 Outlier root cause analysis for indicator SPI11 .....	187
Table 53 Outlier root cause analysis for indicator SPI12 .....	187
Table 54 Outlier root cause analysis for indicator SPI13 .....	188
Table 55 Outlier root cause analysis for indicator SPI14 .....	189
Table 56 Outlier root cause analysis for indicator SPI15 .....	190
Table 57 Outlier root cause analysis for indicator SPI16 .....	190
Table 58 Outlier root cause analysis for indicator SPI17 .....	191
Table 59 Outlier root cause analysis for indicator SPI18 .....	192
Table 60 Outlier root cause analysis for indicator SPI19 .....	192
Table 61 Outlier root cause analysis for indicator SPI20 .....	193
Table 62 Outlier root cause analysis for indicator SPI21 .....	194
Table 63 Outlier root cause analysis for indicator SPI22 .....	194
Table 64 Outlier root cause analysis for indicator SPI23 .....	195
Table 65 Outlier root cause analysis for indicator SPI24 .....	196
Table 66 Outlier root cause analysis for indicator SPI25 .....	197
Table 67 Outliers and root causes for Split Airport safety performance indicators over timeline .....	198
Table 68 Forecasts of organisational indicators of Split Airport.....	201
Table 69 Initial forecast of organisational indicator OI1 Number of aircraft operations.....	202
Table 70 First initial forecast of Split Airport safety performance indicators (forecasting using temporal causal model) .....	203
Table 71 Second initial forecast of Split Airport safety performance indicators (ARIMA & smoothing methods).....	204
Table 72 Associated forecast of Split Airport safety performance targets (ARIMA & smoothing methods).....	204
Table 73 Second initial forecast of Split Airport safety performance indicators (smoothing methods only).....	205
Table 74 Associated forecast of Split Airport safety performance targets (smoothing methods only).....	206
Table 75 Increase of organisational indicator OI1 Number of aircraft operations.....	209
Table 76 Decrease of organisational indicator OI1 Number of aircraft operations .....	213
Table 77 Increase of organisational indicator OI2 Number of passengers .....	216
Table 78 Decrease of organisational indicator OI2 Number of passengers .....	219

Table 79 Dataset of organisational indicators (OIs) and safety performance indicators (SPIs) at the Split Airport including newly established SPI26..... 223  
Table 80 Fit statistics for top causal models including newly established SPI26..... 225  
Table 81 Proposed mitigation measures for newly established SPI26 ..... 228  
Table 82 Dataset of observed and predicted organisational and safety performance indicators at the Split Airport..... 233  
Table 83 Proposed mitigation measures to improve safety performance at the Split Airport 236

## LIST OF FIGURES

Figure 1 The evolution eras of safety management.....	8
Figure 2 Concept of accident causation – James Reason’s Swiss Cheese Model .....	15
Figure 3 Concept of practical drift.....	17
Figure 4 ICAO framework of the SMS .....	22
Figure 5 Phased approach of SMS implementation .....	25
Figure 6 Safety risk management process.....	27
Figure 7 Example of the safety risk management process at an airport.....	28
Figure 8 Safety assurance.....	34
Figure 9 Comprehensive overview of the aviation safety management system .....	37
Figure 10 Safety performance management process .....	39
Figure 11 Types of analysis .....	45
Figure 12 Data-driven decision-making process.....	49
Figure 13 Data-driven decision making and safety performance management .....	51
Figure 14 Leading and lagging indicators .....	55
Figure 15 Example of safety performance targets with safety objectives.....	58
Figure 16 Example of representation of safety triggers/ alert levels.....	59
Figure 17 Example of setting safety triggers and monitoring achievement of targets.....	60
Figure 18 Safety management levels .....	61
Figure 19 Reactive safety management system.....	62
Figure 20 Proactive safety management system .....	64
Figure 21 Predictive safety management system .....	65
Figure 22 Example of Airbus Flight Data Analysis Suite.....	68
Figure 23 Example of frequency histogram .....	72
Figure 24 Example of stem-and-leaf plot .....	72
Figure 25 Examples of Q-Q plots .....	73
Figure 26 Example of box plot .....	74
Figure 27 Examples of trendline curves for number of flights.....	76
Figure 28 Example of forecasting number of flights using Holt's linear trend.....	77
Figure 29 Example of forecasting number of flights using Brown's linear trend .....	78
Figure 30 Example of forecasting number of flights using damped trend.....	78
Figure 31 Example of forecasting number of flights using simple exponential smoothing method.....	79
Figure 32 Example of forecasting number of flights using simple seasonal exponential smoothing method.....	80
Figure 33 Example of forecasting number of flights using Winter's additive method.....	80
Figure 34 Example of forecasting number of flights using Winter's multiplicative method .....	81
Figure 35 Example of forecasting number of flights using moving average method.....	82
Figure 36 Example of forecasting number of flights using ARIMA modelling.....	83
Figure 37 Example of forecasting using econometric analysis of traffic demand.....	84
Figure 38 EUROCONTROL Seven-Year Forecast 2021-2027 .....	86
Figure 39 Trend projections of passenger traffic (a) and cargo traffic (b) at Franjo Tuđman Airport .....	89
Figure 40 Forecast of passenger traffic at Franjo Tuđman Airport .....	92
Figure 41 Forecast of cargo traffic at Franjo Tuđman Airport.....	92

Figure 42 Probability density function (EM method).....	102
Figure 43 Probability distribution function (EM method) .....	102
Figure 44 Probability density function (PD method) .....	106
Figure 45 Probability distribution function (PD method).....	106
Figure 46 Safety performance indicator (SPI) in reactive safety management system .....	110
Figure 47 Safety performance indicator (SPI) in proactive safety management system .....	111
Figure 48 Safety performance indicator (SPI) in predictive safety management system .....	111
Figure 49 Incline/ decline of SPIs (1-14) in the period 2014-2019.....	114
Figure 50 Incline/ decline of SPIs (1, 2, 11 and 14) in the period 2014-2019 vs. target area	114
Figure 51 Incline/ decline of SPI15 in the period 2014-2019 vs. target area.....	115
Figure 52 Incline/ decline rate of SPIs in 2017 vs. 2016.....	116
Figure 53 Incline/ decline of SPIs in 2017 vs. target area.....	116
Figure 54 Incline/ decline rate of SPIs in 2019 vs. 2018.....	117
Figure 55 Incline/ decline of SPIs in 2019 vs. target area.....	118
Figure 56 Total number of reported occurrences (hazards) – Forecast till 2024.....	119
Figure 57 Number of hazards (MOR) – Forecast till 2024 .....	120
Figure 58 Number of conducted risk assessments & risk mitigations – Forecast till 2024 ....	121
Figure 59 Number of Safety Review Boards (SRBs) – Forecast till 2024 .....	122
Figure 60 Number of reported occurrences vs. number of flight hours – Forecast till 2024 .	123
Figure 61 Overview of Safety Management System methodologies.....	124
Figure 62 Liaison between Safety Management System methodologies.....	124
Figure 63 Granger causality scenario.....	126
Figure 64 Overview of the relationship between hypotheses, predictions, laws, and theories	130
Figure 65 Link between causation and prediction.....	134
Figure 66 Histograms of organisational and safety performance indicators.....	142
Figure 67 Box plots of each indicator .....	143
Figure 68 Initial forecast of safety performance indicators SPI1 – <i>Total number of recorded occurrences</i> for the period April 2020 – March 2022.....	145
Figure 69 Initial forecast of safety performance indicators SPI2 – <i>Number of reported MOR occurrences</i> for the period April 2020 – March 2022.....	146
Figure 70 Initial forecast of safety performance indicators SPI3 – <i>Number of recorded changes</i> for the period April 2020 – March 2022.....	146
Figure 71 Initial forecast of safety performance indicators SPI4 – <i>Number of conducted risk assessments</i> for the period April 2020 – March 2022.....	146
Figure 72 Initial forecast of safety performance indicators SPI5 – <i>Number of detected unacceptable risks</i> for the period April 2020 – March 2022.....	147
Figure 73 Initial forecast of safety performance indicators SPI6 – <i>Number of held Safety Review Boards</i> for the period April 2020 – March 2022.....	147
Figure 74 Initial forecast of safety performance indicators SPI7 – <i>Number of conducted audits/ inspections</i> for the period April 2020 – March 2022 .....	148
Figure 75 Initial forecast of safety performance indicators SPI8 – <i>Number of determined non-compliances (findings)</i> for the period April 2020 – March 2022 .....	148
Figure 76 Overall quality of cause-effect model.....	149
Figure 77 Cause-effect model of individual organisational and safety performance indicators relations .....	150
Figure 78 Impact diagrams – causes .....	151
Figure 79 Impact diagrams – effects.....	152

Figure 80 Top inputs for each safety performance indicator .....	153
Figure 81 Impact diagram of causes and effects of safety performance indicator SPI1 .....	153
Figure 82 Top inputs for safety performance indicator SPI1 .....	154
Figure 83 Observed and predicted series for safety performance indicator SPI1 .....	155
Figure 84 Impact diagram of organisational indicator OI3 on safety performance indicator SPI1 .....	155
Figure 85 Increase of organisational indicator OI3.....	156
Figure 86 Decrease of safety performance indicator SPI1 due to increase of OI3 .....	156
Figure 87 Impact diagram of organisational indicator OI9 on safety performance indicator SPI1 .....	157
Figure 88 Decrease of organisational indicator OI9 .....	157
Figure 89 Decrease of safety performance indicator SPI1 due to decrease of OI9 .....	158
Figure 90 Impact diagram of safety performance indicator SPI7 on safety performance indicator SPI1.....	158
Figure 91 Increase of safety performance indicator SPI7 .....	159
Figure 92 Decrease of safety performance indicator SPI1 due to increase of SI17 .....	159
Figure 93 Predictive methodology incorporated in aviation safety management.....	160
Figure 94 Conceptual model of predictive safety management in aviation .....	162
Figure 95 Split Airport.....	163
Figure 96 Passenger traffic and trendline at Split Airport in the period from 1966 to 2021...	164
Figure 97 Split Airport safety performance indicators from 2014 to 2021 .....	171
Figure 98 Overall quality of causal model .....	173
Figure 99 Causal model of Split Airport organisational and safety performance indicators....	173
Figure 100 Direct impact of individual organisational indicators on safety performance indicators .....	174
Figure 101 Impacts of individual safety performance indicators .....	175
Figure 102 Impact diagrams – causes .....	177
Figure 103 Impact diagrams – effects.....	178
Figure 104 Outliers and root causes of indicator OI1 .....	179
Figure 105 Outliers and root causes of indicator SPI1 .....	180
Figure 106 Outliers and root causes of indicator SPI2 .....	181
Figure 107 Outliers and root causes of indicator SPI3 .....	182
Figure 108 Outliers and root causes of indicator SPI4 .....	183
Figure 109 Outliers and root causes of indicator SPI5 .....	183
Figure 110 Outliers and root causes of indicator SPI7 .....	184
Figure 111 Outliers and root causes of indicator SPI8 .....	185
Figure 112 Outliers and root causes of indicator SPI9 .....	186
Figure 113 Outliers and root causes of indicator SPI10 .....	186
Figure 114 Outliers and root causes of indicator SPI11 .....	187
Figure 115 Outliers and root causes of indicator SPI12 .....	188
Figure 116 Outliers and root causes of indicator SPI13 .....	188
Figure 117 Outliers and root causes of indicator SPI14 .....	189
Figure 118 Outliers and root causes of indicator SPI15 .....	190
Figure 119 Outliers and root causes of indicator SPI16 .....	191
Figure 120 Outliers and root causes of indicator SPI17 .....	191
Figure 121 Outliers and root causes of indicator SPI18 .....	192
Figure 122 Outliers and root causes of indicator SPI19 .....	193



Figure 123 Outliers and root causes of indicator SPI20 .....	193
Figure 124 Outliers and root causes of indicator SPI21 .....	194
Figure 125 Outliers and root causes of indicator SPI22 .....	195
Figure 126 Outliers and root causes of indicator SPI23 .....	195
Figure 127 Outliers and root causes of indicator SPI24 .....	196
Figure 128 Outliers and root causes of indicator SPI25 .....	197
Figure 129 Outliers and root causes over timeline .....	199
Figure 130 Outliers and root causes over timeline – impact of SPI10.....	200
Figure 131 Forecasts of Split Airport safety performance indicators (forecasting using temporal causal model) .....	203
Figure 132 Forecasts of Split Airport safety performance indicators and targets (ARIMA & smoothing methods).....	207
Figure 133 Forecasts of Split Airport safety performance indicators and targets (smoothing methods only).....	208
Figure 134 Impact diagram of increased organisational indicator OI1 on safety performance indicators .....	210
Figure 135 Predicted safety performance indicators due to increased organisational indicator OI1 .....	212
Figure 136 Impact diagram of decreased organisational indicator OI1 on safety performance indicators .....	213
Figure 137 Predicted safety performance indicators due to decreased organisational indicator OI1 .....	215
Figure 138 Impact diagram of increased organisational indicator OI2 on safety performance indicators .....	216
Figure 139 Predicted safety performance indicators due to increased organisational indicator OI2 .....	218
Figure 140 Impact diagram of decreased organisational indicator OI2 on safety performance indicators .....	219
Figure 141 Predicted safety performance indicators due to decreased organisational indicator OI2 .....	221
Figure 142 Causal model of Split Airport organisational and safety performance indicators including new safety performance indicator .....	226
Figure 143 Impact of newly established safety performance indicator.....	227
Figure 144 Observed and predicted organisational and safety performance indicators over timeline at the Split Airport .....	235

## LIST OF ABBREVIATIONS

AIC	Akaike Information Criterion
AIREP	Accident/Incident Reporting
ADREP	Accident Data Reporting
AIA	Accident Investigation Authority
ALoSP	Acceptable Level of Safety Performance
AM	Accountable Manager
AMO	Approved Maintenance Organisation
ANS	Air Navigation Service
ANSP	Air Navigation Service Provider
AOC	Air Operator Certificate
ARIMA	Auto-Regressive Integrated Moving Average
ASAP	Aviation Safety Action Programme
ASO	Air Safety Order
ASRS	Aviation Safety Reporting System
ATC	Air Traffic Control
ATM	Air Traffic Management
ATO	Approved Training Organisation
ATS	Air Traffic Services
BIC	Bayesian Information Criterion
BP	Booking Profile
CAA	Civil Aviation Authority
CAMO	Continuing Airworthiness Management Organisation
CAST	Commercial Aviation Safety Team
CICTT	Common Taxonomy Team
CINA	International Air Navigation Commission
CPL	Commercial Pilot Licence
CRM	Crew Resource Management
CTAS	Centre TRACON Automation System
CVR	Cockpit Voice Recorder
D3M (DDDM)	Data-Driven Decision-Making
DEMATEL	Decision-Making Trial and Evaluation Laboratory
DFDR	Digital Flight Data Recorders
Doc	Document
DOSA	Dispatch Operations Safety Audit
EASA	European Union Aviation Safety Agency
EM	Expectation Maximization
EU	European Union
EUROCONTROL	European Organisation for the Safety of Air Navigation
FAA	Federal Aviation Administration
FDA	Flight Data Analysis
FDM	Flight Data Monitoring
FDR	Flight Data Recorder
FL	Flight Level
FMS	Flight Management System

FOQA	Flight Operations Quality Assurance
FRMS	Fatigue Risk Management Systems
FSTD	Flight Simulation Training Device
GA	General Aviation
GAP	Gap Analysis
GAQ	Gap Analysis Questionnaire
GASP	Global Aviation Safety Plan
GDP	Gross Domestic Product
IATA	International Air Transport Association
ICAO	International Civil Aviation Organisation
IFR	Instrument Flight Rules
iSTARS	Integrated Safety Trend Analysis and Reporting System
LOSA	Line Operations Safety Audit
LTF	Long-Term Forecast
MM	Maintenance Manual
MoC	Management of Change
MOR	Mandatory Occurrence Report
MTF	Mid-Term Forecast
NATO	North Atlantic Treaty Organisation
NASA	National Aeronautics and Space Administration
NM	Network Manager
NOP	Network Operational Plan
NOSS	Normal Operations Safety Survey
NPP	Network Performance Plan
NSP	Network Strategy Plan
OCC	Operations Control Centre
OIs	Organisational Indicators
OM	Operations Manual
OMM	Organisation's Management Manual
OPS	Operations
PANS	Procedures for Air Navigation Services
PD	Projection Detruncation
RAIO	Regional Accident and Incident Investigation Organisation
RASGs	Regional Aviation Safety Groups
RMSE	Root Mean Squared Error
RMSPE	Root Mean Squared Percent Error
RPASs	Remotely Piloted Aircraft Systems
RSOO	Regional Safety Oversight Organisation
RWA	Replace With Average
RWM	Replace With Median
RWP	Replace With Percentile
SA	Safety Assurance
SAG	Safety Action Group
SARPs	Standards and Recommended Practices (ICAO)
SD	Standard deviation
SDCPS	Safety Data Collection and Processing System
SDR	Service Difficulty Report

SM	Safety Management
SMA	Simple Moving Average
SMART	Specific, Measurable, Achievable, Relevant and Timely
SMM	Safety Management Manual
SMS	Safety Management System
SOPs	Standard Operating Procedures
SPIs	Safety Performance Indicator
SPI-TF	Safety Performance Indicators Task Force
SPM	Safety Performance Management
SPTs	Safety Performance Target
SRBs	Safety Review Boards
SRM	Safety Risk Management
SSP	State Safety Programme
STATFOR	Statistics and Forecast Service
STDEVP	Population Standard Deviation
STF	Short-Term Forecast
SUG	STATFOR User Group
UN	United Nations
USA	United States of America
USOAP	Universal Safety Oversight Audit Programme (ICAO)
VOR	Voluntary Occurrence Report

## **AUTHOR'S CURRICULUM VITAE AND LIST OF PUBLISHED WORK**

### **CURRICULUM VITAE**

Dajana Bartulović was born in Zadar on January 10, 1987. After graduating from the Gymnasium and the Professional School, in 2005 she enrolled university study programme, at the Faculty of Transport and Traffic Sciences. In 2007, she also enrolled the Faculty of Natural Sciences – Department of Mathematics, where she completed three years of study. At the Faculty of Transport and Traffic Sciences, she completed her undergraduate university study programme in 2010, and in 2012, she finished graduate university study programme, under the mentorship of prof. Sanja Steiner PhD. During her studies, she was engaged as a demonstrator in the courses – Air Traffic Safety and Elements of Air Traffic Safety, and she was actively engaged in research work. By the end of her studies in 2012, she has already published three scientific papers at international conferences. Also, in 2012, she was nominated for the Rector's Award for co-authored professional paper, in the field of aviation safety. She enrolled in doctoral study programme in 2019, at the Faculty of Transport and Traffic Sciences, and finished it in 2022. Currently, she has 27 published papers in international conferences and journals, of which seven are in journals referenced in the WoS CC database. Operational work experience in the field of aviation safety and other related areas, is obtained by working for the Croatian Civil Aviation Agency, the Transport Department of the City of Zagreb, air operators Geofoto and TIMAir, and the pilot training organisation of the Faculty of Transport Sciences – Croatian Aviation Training Centre, where she performed duties and functions of the Safety, Compliance and Quality Manager until 2020. Work at the Croatian Academy of Sciences and Arts and the Institute of Transport and Communications ensured obtaining scientific and research experience. She gained teaching experience by working at the Faculty of Transport Sciences, since 2020 (until today) as an associate (lecturer/ assistant) – she holds classes of exercises and seminars in seven courses of undergraduate and graduate university study programmes at the Department of Air Transport and the Department of Aeronautics. She has excellent computer skills, which is reflected in the knowledge and work with a large number of applications and softwares. She actively speaks English, passively German and Italian.

## LIST OF PUBLISHED WORK

### Journal articles (scientific and review papers)

1. Stanivuk, T., Bartulović, D. & Bartulović, D., 2022. Simulating Behavior Pattern of Key Performance Indicators to Improve Organization's Safety Performance in Maritime Transport. *Transactions on Maritime Science*, 11(2), pp. 1-16, DOI: 10.7225/toms.v11.n02.w05.
2. Bartulović, D., Abramović, B., Brnjac, N. & Steiner, S., 2022. Role of Air Freight Transport in Intermodal Supply Chains. *Transport Research Procedia*, 64, pp. 119-127, DOI: 10.1016/j.trpro.2022.09.015.
3. Božičević, J., Lovrić, I., Bartulović, D., Steiner, S., Roso, V. & Pašagić Škrinjar, J., 2021. Determining Optimal Dry Port Location for Seaport Rijeka Using AHP Decision-Making Methodology. *Sustainability*, 13(11), pp. 1-21, DOI: 10.3390/su13116471.
4. Bartulović, D., 2021. Predictive Safety Management System Development. *Transactions on Maritime Science*, 10(1), pp. 135-146, DOI: 10.7225/toms.v10.n01.010.
5. Lovrić, I., Bartulović, D. & Steiner, S., 2020. The Influence of Dry Port Establishment on Regional Development through Regional Development Index. *Transactions on Maritime Science*, 9(2), pp. 1-23, DOI: 10.7225/toms.v09.n02.012.
6. Lovrić, I., Bartulović, D. & Steiner, S., 2020. Concept of the Decision-Making Model for Establishment of Dry Port on the Sample of Rijeka Seaport. *Our Sea – International Journal of Maritime & Technology*, 67(3), pp. 232-243, DOI: 10.17818/NM/2020/3.7.
7. Lovrić, I., Bartulović, D., Viduka, M. & Steiner, S., 2020. Simulation analysis of Seaport Rijeka operations with established dry port. *Pomorstvo – Scientific Journal of Maritime Research*, 34 (2020), 1; pp. 129-145 DOI: 10.31217/p.34.1.15.
8. Marušić, Ž., Bartulović, D. & Maković, B., 2015. Methods to Detect and Prevent Fatigue in Ageing Aircraft Structures. *Technical Gazette*, 22(3), pp. 793-803. DOI: 10.17559/TV-20140702111704.
9. Marušić, Ž., Bartulović, D. & Rukavina, A., 2013. [Hydroaviation model in purpose of improving the tourist transport to islands]. [*Modern Traffic: A Journal of Traffic Theory and Practice*], 33(1-2), pp. 147-149. *Croatian*.

### Papers in conference proceedings (scientific papers in conference proceedings)

1. Bartulović, D. & Steiner, S., 2022. Predictive Safety Risk Assessment Methods Applicable in Aviation Ergonomics. Springer – Proceedings of the 9th International Ergonomics Conference – Ergonomics 2022, Zagreb, Faculty of Transport and Traffic Sciences, 7-10 December 2022, pp. 1-8, <https://www.h-e-d.hr/conferences.htm>.
2. Bartulović, D., Abramović, B., Brnjac, N. & Steiner, S., 2022. Role of Air Freight Transport in Intermodal Supply Chains. *Transport Research Procedia – ZIRP 2022 International Scientific Conference „The Science and Development of Transport”*. Šibenik: Faculty of Maritime Studies and Transport, 28-30 September 2022, pp. 119-127, <https://www.sciencedirect.com/science/article/pii/S2352146522006299>.

3. Bartulović, D. & Steiner, S., 2022. Cause-Effect Relations between Organisational and Safety Performance Indicators. ICTS 2022 Conference Proceedings. Portorož: Faculty of Maritime Studies and Transport, 23-24 May 2022, pp. 49-57, <https://icts.sdzp.org/wp/wp-content/uploads/2022/06/ICTS-2022-Proceedings-CIP.pdf>.
4. Bartulović, D. & Steiner, S., 2020. *Liaison between Proactive and Predictive Methodology of Aviation Safety Management System*. ICTS 2020 Conference Proceedings. Portorož: Faculty of Maritime Studies and Transport, 17-18 September 2020, pp. 34-41, <https://icts.sdzp.org/wp/wp-content/uploads/2020/09/Proceedings-ICTS-2020.pdf>.
5. Steiner, S., Fikleš, D. & Bartulović, D., 2018. Methodological Approach to Fatigue Risk Mitigation in Flight Operations. Proceedings of the Fourth International Conference on Traffic and Transport Technology (ICTTE). Belgrade: City Net Scientific Research Centre Ltd, 27-28 September 2018, pp. 14-21.
6. Steiner, S., Bartulović, D. & Fikleš, D., 2018. Integration of Fatigue Risk Management in Aviation Safety Management System. 18th International Conference on Transport Science – ICTS 2018, Conference Proceedings. Portorož: Faculty of Maritime Studies and Transport, 14-15 June 2018, pp. 351-357.
7. Marušić, Ž., Bartulović, D., Kezele, L. & Sumpor, D., 2018. General and Ergonomic Advantages of Glass Cockpit Aircraft Used for Pilot Training. Book of Proceedings of the 7th International Ergonomics Conference „Ergonomics 2018 – Emphasis on Wellbeing“. Zagreb: Croatian Ergonomic Society, 13-16 June 2018, pp. 267-274, <https://www.h-e-d.hr/conferences.htm>.
8. Madunić, M., Huzjan, P., Bartulović, D. & Marušić, Ž., 2018. Contribution to the Surveillance and Safety of Road Traffic by Using Drones on Motorways and Critical Road Sections. Proceedings of ISEP 2018, Ljubljana, 26-27 March 2018, pp. P12-P12.
9. Madunić, M., Huzjan, P., Bartulović, D. & Marušić, Ž., 2018. Synergy of Road and Helicopter Emergency Medical Services for the Purpose of Improving Medical Care after Traffic Accidents. Proceedings of ISEP 2018, Ljubljana, 26-27 March 2018, pp. P13-P13.
10. Marušić, Ž., Filipović-Grčić, M. & Bartulović, D., 2017. The Impact of the Vibration Characteristics of Helicopter Mil-Mi8 on Reliability, Durability and Transport Characteristics. 25th International Symposium in Traffic, ISEP 2017, Ljubljana: Electrotechnical Association of Slovenia, 27-28 March 2017, pp. 14-17.
11. Marušić, Ž., Filipović-Grčić, M. & Bartulović, D., 2017. Criteria for Selecting the Optimal Characteristics of Helicopter for Emergency Medical Services during the Summer and Winter Tourist Season. 25th International Symposium in Traffic, ISEP 2017, Ljubljana: Electrotechnical Association of Slovenia, 27-28 March 2017, pp. 21-26.
12. Marušić, Ž., Bartulović, D. & Forjan, I., 2015. Improvement of Crew Resource Management (CRM) Regarding Germanwings Flight 9525 Disaster. 17th International Conference on Transport Science – ICTS 2015, Portorož, Slovenia, 21-22 May 2015, pp. 23-28.

13. Marušić, Ž., Bartulović, D. & Mikulić, D., 2015. Cold Expansion Techniques to Mitigate Fatigue Cracks in Aircraft Structure. 23rd International Symposium on Electronics in Transport – ISEP 2015, Ljubljana, Slovenia, 22-23 March 2015, pp. 33-37.
14. Marušić, Ž., Maković, B. & Bartulović, D., 2014. [Development of Structural Health Monitoring]. 34th Conference on Transport Systems – Traffic Automation 2014, Dubrovnik, Croatia, 5-9 November 2014. *Croatian*.
15. Marušić, Ž., Rukavina, A. & Bartulović, D., 2013. Establishment of Helicopter Emergency Medical Service in Bosnia and Herzegovina. IV International Symposium New Horizons of Traffic and Communications, Doboj, Bosnia and Herzegovina, 22-23 November 2013.
16. Paljetak, J., Bartulović, D. & Bračić, M., 2012. Safety Management System as the Tool for Airport Benchmarking Process. Proceedings of the First International Conference on Traffic and Transport Engineering (ICTTE). Belgrade: Scientific Research Centre Ltd, 29-30 November 2012, pp. 479-488.
17. Marušić, Ž., Bartulović, D. & Rukavina, A., 2012. Seaplane Transport Model in Order to Improve Tourist Traffic to the Islands. International conference – The Science and Development of Transport (ZIRP 2012), Zagreb, Croatia, 17 April 2012, pp. 250-267.
18. Paljetak, J., Bartulović, D. & Steiner, S., 2011. [Advantages of Hydroaviation from Environmental Point of View]. International Scientific Conference – Ecological Problems of Traffic Development, Proceedings. Zagreb: Croatian Academy of Sciences and Arts, Scientific Council for Transport, 24 February 2011, pp. 277-285. *Croatian*.

Evaluation papers (theses)

1. Bartulović, Dajana: [*Risk Assessment Methodology in Air Traffic Safety Management System*], Master Thesis, Faculty of Transport and Traffic Sciences, Zagreb, 2012. *Croatian*.
2. Bartulović, Dajana: [*Performance Analysis of the Commercial Aircraft*], Bachelor Thesis, Faculty of Transport and Traffic Sciences, Zagreb, 2010. *Croatian*.