

Functional Efficiency Optimization of Intersection Donje Svetice and Planinska Street

Gurung, Arun

Master's thesis / Diplomski rad

2016

Degree Grantor / Ustanova koja je dodijelila akademski / stručni stupanj: **University of Zagreb, Faculty of Transport and Traffic Sciences / Sveučilište u Zagrebu, Fakultet prometnih znanosti**

Permanent link / Trajna poveznica: <https://urn.nsk.hr/urn:nbn:hr:119:451299>

Rights / Prava: [In copyright](#)/[Zaštićeno autorskim pravom.](#)

Download date / Datum preuzimanja: **2025-04-01**



Repository / Repozitorij:

[Faculty of Transport and Traffic Sciences -
Institutional Repository](#)



UNIVERSITY OF ZAGREB
FACULTY OF TRANSPORT AND TRAFFIC SCIENCES

Arun Gurung

**FUNCTIONAL EFFICENCY OPTIMIZATION OF
INTERSECTION DONJE-SVETICE AND PLANINSKA
STREET**

MASTER THESIS

Zagreb, 2016

University of Zagreb
Faculty of Transport and Traffic Sciences

MASTER THESIS

**FUNCTIONAL EFFICIENCY OPTIMIZATION OF
INTERSECTION DONJE-SVETICE AND PLANINSKA
STREET**

**OPTIMIZACIJA FUNKCIONALNE UČINKOVITOSTI
RASKRIŽJA ULICA DONJE SVETICE – PLANINSKA U
ZAGREBU**

Mentor: Hrvoje Pilko PhD

Student: Arun Gurung

JMBAG: 0135239941

Zagreb, July 2016

Summary

The growth of traffic congestion on the streets is a major concern to every urban environment leading to high operation cost, loss of time, high delay and high travel time, increase in fuel consumption and in the emission of air pollutants. Donje Svetice and Planinska Street intersection is located in the City of Zagreb with high traffic congestion on peak hours leading to long queues on approaches. In order to curb the congestion on the approaches, functional efficiency optimization of intersection Donje Svetice and Planinska Street is taken as master thesis.

The main objective of the study is to propose the design variants for the congestion of traffic on approaches after preliminary study of the intersection site and further design variants is analyzed in SIDRA for *LOS* (level of service), degree of saturation, control delay, signal phasing and movement timings. Design variants for intersection **A** (Donje Svetice and Planinska Street) are VA_I, VA_II and VA_III and for intersection **B** (Planinska, Square Volovcica and Ivanicgradska Street) is VB_I. Sensitivity analysis is carried out for the best variant for design period of 20 years. Network analysis is carried out to know the effect of minor intersection of adjacent place for the current volume of traffic as well as for the design period of 20 years.

After the analysis of the intersections in SIDRA, the variant VA_III and VB_I is the most appropriate solution with lowest delay values and improved level of service for intersections. It eliminates the traffic congestion on the approach Planinska Street East.

Keywords: functional efficiency; roundabouts; optimization; level of service; design variant

Contents

Summary.....	i
Contents.....	ii
1 INTRODUCTION.....	1
2 BASIC INTERSECTION CHARACTERISTICS.....	3
2.1 General requirement for intersection.....	3
2.2 Intersection traffic.....	5
2.3 Classification of intersection.....	6
2.4 Intersection design variant.....	8
3 FUNCTIONAL EFFICIENCY METHODOLOGY.....	10
3.1 Signalized intersections.....	10
3.2 Two-way STOP-controlled.....	13
4 ANALYSIS OF INTERSECTION DONJE-SVETICE AND PLANINSKA STREET.....	18
4.1 Basic layout parameters.....	18
4.2 Existing design.....	21
4.3 Traffic volume.....	23
5 DESIGN VARIANTS PROPOSAL.....	26
6 FUNCTIONAL EFFICIENCY OPTIMIZATION.....	29
6.1 Variant VA_O.....	29
6.2 Variant VA_I.....	31
6.3 Variant VA_II.....	34
6.4 Variant VA_III.....	36
6.5 Variant VB_O.....	39
6.6 Variant VB_I.....	42
6.7 Sensitivity analysis.....	44
6.8 Network analysis.....	50
6.9 Network analysis for design period of 20 years.....	56
7 CONCLUSION.....	65
8 BIBLIOGRAPHY.....	67
List of Figures.....	70
List of Tables.....	73
Appendix.....	74

1 INTRODUCTION

Signalized intersections are important elements in the urban transportation network and carry heavy movement of motorized, non-motorized vehicles and pedestrians which creates conflicts among crossing, turning and merging maneuvers. Traffic congestion is one of many serious global problems of both developed and developing countries. It always exerts a negative externality up on the society and poses severe threat to economy as well as the environment [Ayehu, 2015]. Congestion become a common characteristic in urban road transportation system of the cities of developing nations which results in high operation cost, loss of time, high delay, high travel time and increase in fuel consumption [Haregewoin, 2010].

Donje-Svetice and Planinska Street intersection is the intersections located in the City of Zagreb. It has an area of 641km² with a population of 792,875 thousand. The population of city is increasing by the influx of migrants from nearby counties. Traffic congestion is growing in the city in high pace with the increase in the number of vehicles purchased every year with pedestrian volume.

Intersection of Donje-Svetice and Planinska Street faces traffic congestion on the Planinska Street East limiting the mobility of road use and increase in the delay and fuel consumption affecting the performance of the intersection.

The overall objective of this research is to assess the current situation and quantify the functional efficiency and the level of service of the intersection. Specific objective is to evaluate the intersection functional efficiency of the proposed variant design solutions.

The report for the master thesis consists of seven chapters;

1. Introduction;
2. Basic intersection characteristics;
3. Functional efficiency methodology;
4. Analysis of intersection Donje-Svetice and Planinska Street;
5. Design variant proposal;
6. Functional efficiency optimization; and
7. Conclusion.

Chapter two reports the basic theoretical intersection characteristics. This chapter discusses about the basic parameters for intersection dimensioning and general requirement for intersection as well as for achieving high level of traffic safety. In this chapter intersection is classified according to traffic and operational construction design, number of approaches, possibilities of movements, angle of crossing roads and symmetry. General and functional properties as well as design variants of intersection are also presented. Chapter three discusses the existing functional efficiency methodology and adopted here from HCM2010. Chapter four gives the description about the study area and general characteristics of the intersection. Details about the traffic survey are also presented in this chapter. Chapter five presents the proposal of intersection design variants. Chapter six covers analysis of design variants in SIDRA simulation tool. Conclusions and recommendations are presented in Chapter seven.

2 BASIC INTERSECTION CHARACTERISTICS

Intersection is an area shared by two or more roads in which traffic flows are merging, diverging and interweaving to reach to their desired destination. Traffic intersection is complex on any location of urban and suburban road traffic network. In road transport network, intersection determines the level of traffic safety and functional efficiency of the transport system. It represents complex task for planning, designing and modeling phase. All the data's and formulas are obtained from the HCM2010.

Intersection can be classified into:

1. Level intersection;
2. Grade separated intersection;
3. Combined intersections.

Basic parameters for intersection dimensioning are one of the most important phases in planning an intersection. In an intersection, main approaches are determined based on the characteristics of the intersection zone using criteria's stated below. The road with dominant traffic volume is main approach.

1. Class/type of road;
2. Regulation of the observed and the neighboring intersection;
3. Guidance of public transport vehicles;
4. Design speed;
5. Traffic volume;
6. Optical and aesthetic impression.

2.1 General requirement for intersection

The requirement for the geometric design and usage of the intersection should be reviewed with basic goal criteria where the level of traffic safety is mandatory.

• **Traffic safety:** intersection will meet the necessary level of traffic safety if they meet the following requirements:

- *Timely recognizable*; design of all approaches need to be optimal so drivers could be prepared and ready to recognize all traffic situations that are in front of them.
- *Sight distance*; good and timely detection/recognition.
- *Understandable*; to all participants should be clearly visible in which way to turn, who should merge, diverge and how and where are the possible conflicts.

—*Adequate for passing through movements*; design characteristics should correlate with drivability and vehicle geometric characteristics as well as with the requirement of non-motorized traffic participants.

The level of traffic safety is achieved higher by the following criteria:

1. Drivers need to clarify the relationship between desired vehicle speed and traffic situations;
2. For traffic participants, more than two simultaneous decisions making must not be applied;
3. On the level of traffic and intersection concept, in urban areas it's necessary to promote the reduction of vehicles speed limit;
4. Adequate sight distance and visual contact between motorized and non-motorized traffic participants should be provided in modelling and design phase;
5. In urban areas, intersection should be appropriately equipped with public traffic light.

• **Quality of traffic operation**; sufficient quality of traffic flow should be provided, especially in cases when non-motorized traffic is present. In urban areas, sufficient capacity should be provided for roads in peak hours without long delays, in the longitudinal and in turning directions. With the introduction of traffic light signalization, increases the intersection capacity despite small extension in delay. With the help of intelligent transport system, it is possible to harmonize the neighboring intersections and to improve the quality of traffic operation and traffic safety of all traffic users.

• **Impact on the environment and ecology**; intersection should be modeled as to be less harmful to spatial area and the environment. The following must be fulfilled to satisfy the environment:

1. *Landscape level of disruption*; in locating, designing and equipping intersections, they must adjust to environment and must respect historical sights and monuments, taking into account of sight distance and general traffic safety during surface intersection greening and incorporate and fit into the existing urban area.
2. *The level of noise and exhaust emission*; the level of noise and air pollution can be reduced by equalization of driving speed, closely aligned the operationalization of traffic lights with traffic demand, designing the phase to reduce the slope of traffic route with the intersection and co-ordinate the types of roadway surface with the requirement for good acceptability and reduced noise level.
3. *Occupation and fragmentation of land*; area should be regulated in a reasonable framework by keeping a rational relationship between spatial occupancy and component solution usability, predict the transition location of the transverse and rational use of land areas, especially near the urban areas.

4. Economical solutions; it's necessary to implement comparison and evaluation of intersection variants by quantifying construction, user and traffic costs. The elements for the evaluation procedure are costs of construction and maintenance, time and exploitation and traffic accident costs. The level of traffic safety must be sufficient enough and hence to obtain the relationship between cost and traffic safety. In any situations, it always requires sufficient level of traffic safety therefore it is necessary to determine the relationship of cost and traffic safety components. It is also necessary to find which cost is appropriate and sufficient for particular traffic flow quality.

2.2 Intersection traffic

Intersection traffic is a complex traffic action affecting traffic safety and functional efficiency. Intersection movements are determined by the traffic design parameters. Traffic design parameters are intersection design/type, traffic management, routing design and cross-section, traffic demand flow and structure, vehicle speed and sight distance.

The management of intersection traffic flows is a result of design as well as traffic control solution. Traffic flows are distinguished by their nature. Traffic demand flows are divided into uninterrupted traffic flow and interrupted traffic flow.

• **Uninterrupted traffic flow**; driving conditions under which vehicle in transition of the road section or traffic lane must stop because of factors within the traffic flow. The basic features of uninterrupted traffic flow are:

1. Uniform speed at sharp angle of merging and diverging without stopping ($V_1 \approx V_2$);
2. Ensure sufficient sight distance with the help of well-placed design elements;
3. Spatial and temporal gaps in main traffic flow are relatively short;
4. Increased requirement for training and skills of drivers;
5. Unsuitable for the introduction of light-signaling devices.

• **Interrupted traffic flow**; driving conditions under which vehicles on road section or traffic lane, must necessary stop in front of the intersection because of traffic signs or signals. The basic features of interrupted traffic flow are flow that merge or cross and passes the conflict zone at a low speed ($V_1 \gg V_2$) or stops under right angles. Conflict zone can be reduced to small area with short path vehicles suitable for the introduction of traffic light signalization where minor approaches are neglected and the necessary time gaps are about twice those for uninterrupted traffic flows.

2.3 Classification of intersection

Intersection can be classified by more than one basis or criteria. The classification is based on traffic planning, traffic technical and traffic construction features.

The classification also includes:

1. Analysis of the properties of the traffic flow;
2. Different exchange of traffic flow directions;
3. Traffic regime.

• Classification based on traffic and operational construction design

The classification based on traffic and operational design is to determine the number of conflict points which affects the capacity and safety of the intersection.

The classification is determined as follows:

1. *Level intersections*; is the surface intersection with crossing conflicts. It is more hazardous and delay than grade separated intersection.
2. *Grade separated intersections*; is a “bridge” that eliminates crossing conflicts at intersection by vertical separation of roadways in space. Grade separated intersection cause less hazard and delay than the level intersections.
3. *Combined Intersections*; occur as a transitional formation between level and grade separated intersection but also in combination with a roundabout.

• Classification based on the creation/planning of level intersection

1. *Un-channelized Intersection*; Un-channelized intersection is used mainly in locations where minor or local road cross.
2. *Channelized Intersection*; Channelization is the separation or regulation of conflicting traffic movements into definite paths of travel by traffic islands or pavement marking to facilitate the safe and orderly movements of both vehicles and pedestrians.

• Classification based on the number of approaches

The classification is based on the intersection are as follows:

1. Three-approaches - it's known as T or Y intersection linking three roads at single intersection.
2. Four-approaches - it's most common intersection where crossing over of two roads is involved. It is further divided into two categories depending on the angle by which two roads interest each other.
3. Multi approaches - it involves the crossing over of five or more roads together at a single intersection. It's a rare form of intersection.

- **Other intersection classification**

The classification is based according to the possibilities of movements:

1. Complete - the movement in all direction of the intersection is possible.
2. Incomplete - the movement is limited or even prohibited in some directions of the intersection.

- **Angle of crossing roads;** crossing roads are rectangular and beveled.

- **Symmetry;** are point of symmetry or line of symmetry.

The factors that affect the selection of intersection are:

- Capacity;
- Traffic safety;
- Traffic and approach features;
- Presence of non-motorized traffic;
- Presence of non-motorized traffic;
- Terrain and the environment characteristics;
- Approach geometry relationship;
- Approach geometry relationship;
- Speed limits;
- Sight distance;
- Driver structure and habits.

- **General and functional properties of the intersection**

Intersection designs are generally conceived on the basis of the initial criteria:

- Relevant intersection road function;
- Cross-section of the road (one or two roadways– single, dual, or four lane);
- General intersection dimensioning (approach or crossing, level or grade separated intersection);
- Desirable design speed for intersection roads.

When designing an intersection, following principles are to be followed:

- Intersections on the classic level two level roads – are performed in level or grade separated;
- The choice of appropriate design elements preceded the selection of intersection geometry type, a commitment to use of signaling or some ITS services;

- At the stage of planning and modelling - analysis important intersection parameters capacity and level of service.

2.4 Intersection design variant

• Level intersection (Classical surface intersection)

In the road network, level intersection represents nodes and has been designed to enable functioning of road traffic in one level. They are the most common intersection network design and are constructed in and outside urban areas. They are appropriate for locations on road traffic network. It requires civil basis with verification of all elements according to the criteria of maximum safety, optimum capacity and investments. Example is shown below in Figure 2.1.

They must satisfy:

- Traffic volumes up to $Q \leq 800$ veh/h per driveway;
- Traffic flow time gap $\Delta t \geq 6$ s.

• Principles for design

In modelling process it is necessary to determine parameters as follows:

- the role and significance of road approaches in traffic network;
- distance between intersections;
- design speed for intersection;
- determination of main road;
- drivability and geometric features of intersection;
- capacity and traffic safety.

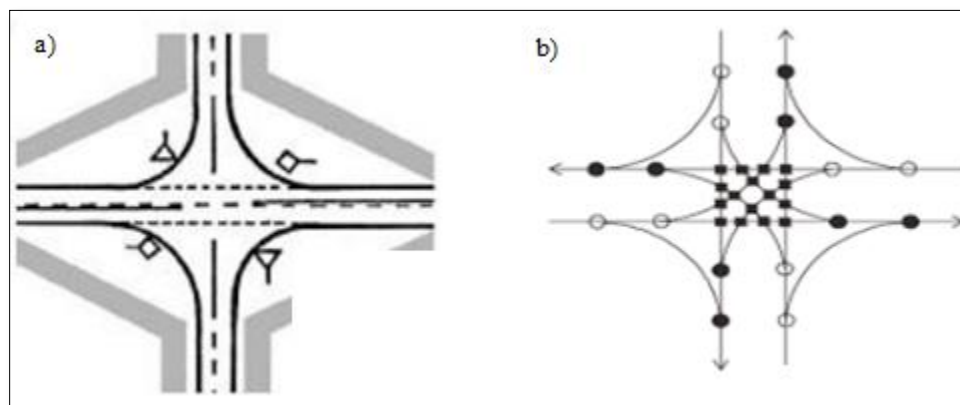

Figure 2-1 a) Classical intersection b) Classical intersection with conflict points, Source:[12]

• **Grade separated intersection**

Traffic object that connects the conflicting traffic flows with the highest level of traffic safety and capacity. It occupies large land areas with high construction cost. It comes into existence when level intersection could not solve the increase in traffic volume. The total traffic volume from main and minor approaches should exceed $Q = 12,000$ veh/day. One such example could be seen on Figure 2-2.

For designing the grade separated intersection, parameters to be taken in account are:

- design speed;
- main traffic approach/direction;
- intersection position;
- distance between neighboring intersections in traffic network.

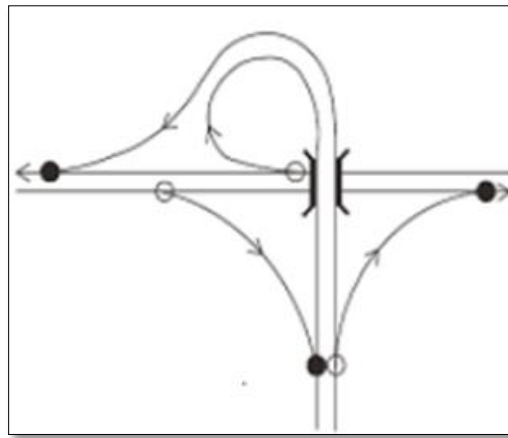

Figure 2-2 One type of the grade separated intersection, Source:[12]

• **Combined intersection**

Combined intersections predominantly occur as a transitional formation between level and grade separated intersection but also with a combination of roundabout. One such example could be seen on Figure 2.3

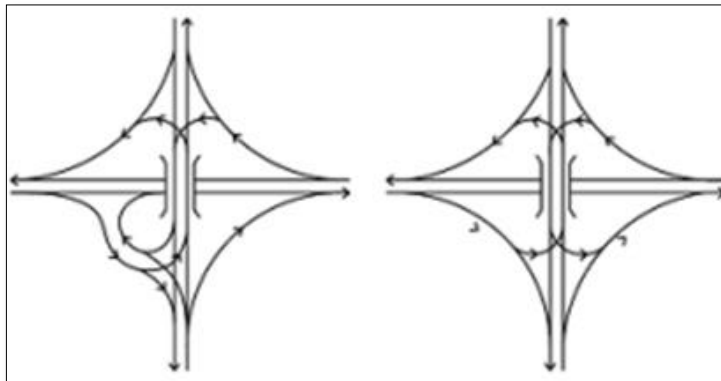

Figure 2-3 Examples of combined intersection, Source:[12]

3 FUNCTIONAL EFFICIENCY METHODOLOGY

The functional efficiency is qualitative measure of the operational state of traffic demand flow and geometry design that includes multiple traffic parameters (capacity, *LOS*, degree of saturation, queue length) [Pilko, 2014]. Here the functional efficiency of intersection is analyzed based on Highway Capacity Manual (HCM) published by Transport Research Board in the United States. It contains concepts, guidelines and computational procedures for computing the capacity and *LOS* of various highway facilities including freeways, highways, arterial roads, all types of intersections, and the effects of mass transit, pedestrians, bicycles [Ali, Hooman, & Rabu].

SIDRA INTERSECTION software use Highway Capacity Manual [HCM 2010] as an advanced intersection analysis tool. Using SIDRA, evaluation of signalized intersection, roundabouts, two-way stop and give-away yield sign control, all-way stop sign control, single-point urban interchanges, and signalized midblock crossing for pedestrians is conveniently achieved.

The HCM2010 version of SIDRA is based on the calibration of most model parameters using HCM2010 defaults as applicable. The capacity of motorized traffic and other features/elements is determining by the use of simulation modelling tools based on different methods; ARCADY, SIDRA, PTV VISSIM, CAPACITO etc.

3.1 Signalized intersections

The main goal of methodology is to analyze the capacity and *LOS* of signalized intersections. The parameters to be considering in analyzing the functional efficiency are the amount and distribution of traffic movements, traffic composition, and geometric parameters.

Capacity is the ratio of demand flow rate, whereas *LOS* is based on the control delay per vehicle. Control delay is the total delay attributed to traffic signal operation for signalized intersections [Council, 2010].

Capacity is based on the saturation flow and saturation flow rate for signalized intersections.

$$c_i = S_i \frac{g_i}{C} \quad (1)$$

where

c_i = capacity of lane group i (*veh/h*);

s_i = saturation flow rate for lane group i (*veh/h*); and

g_i/C = effective green ratio for lane group i .

Degree of saturation; its ratio of flow rate to capacity. Its symbol is X in intersection analysis. It's referred to as degree of saturation [Council, 2010].

$$X_i = \left(\frac{v}{c}\right)_i = \frac{v_i}{s_i \left(\frac{g_i}{C}\right)} = \frac{v_i C}{s_i g_i} \quad (2)$$

where

$X_i = (v/c)_i$ = ratio for lane group i ;

v_i = actual or projected demand flow rate for lane group i (veh/h);

s_i = saturation flow rate for lane group i (veh/h);

g_i = effective green time for the lane group i (s);

C = cycle length (s).

Critical lane groups; critical degree of saturation (v/c ratio), X_c is the ratio for the intersection as a whole for a given signal phase that have the highest flow ratio (v/s) for particular lane groups only. The critical v/c ratio for the intersection is determined by using equation below:

$$X_c = \sum \left(\frac{v}{s}\right)_{ci} \left(\frac{C}{C-L}\right) \quad (3)$$

where

X_c = critical v/c ratio for intersection;

$\sum \left(\frac{v}{s}\right)_{ci}$ = summation of flow ratios for all critical lane groups i ;

C = cycle length (s);

L = total lost time per cycle, computed as lost time, t_L , for critical path of movements (s).

Uniform delay; delay that occur if arrival demand in the lane group is uniformly distributed over time.

$$d_1 = \frac{0.5C(1 - \frac{g}{C})^2}{1 - \left[\min(1, X) \frac{g}{C} \right]} \quad (4)$$

where

d_1 = uniform control delay assuming uniform arrivals (s/veh);

C = cycle length (s);

(Cycle length used in pre-timed signal control, or average cycle length for actuated control)

g = effective green time for lane group (s);

X = v/c ratio or degree of saturation for lane group.

Incremental delay; reflects non-uniform arrivals and some queue carryover between cycles within the analysis period.

$$d_2 = 900T \left[(X - 1) + \sqrt{(X - 1)^2 + \frac{8k l X}{cT}} \right] \quad (5)$$

where

d_2 = incremental delay to account for effect of random and oversaturation queues, adjusted for duration of analysis period and type of signal control;

(this delay component assumes that there is no initial queue for lane group at start of lane group at start of analysis period);

T = duration of analysis period (h);

k = incremental delay factor that is dependent on controller settings;

l = upstream filtering /metering adjustment factor;

c = lane group capacity (veh/h); and

X = lane group v/c ratio or degree of saturation.

Level of service [LOS]; average delay per vehicle is determined for each lane group and aggregated for each approach and for the intersection as a whole. *LOS* is directly related to the delay value. The Table 3.1 shows the criteria for assessing the *LOS* below.

Table 3-1 Criteria that HCM2010 adapts for assessing the *LOS*, Source:[5]

<i>LOS</i>	Delay (s/veh)
A = free flow	≤ 10
B = reasonably free flow	>10-20
C = stable flow	>20-35
D = approaching unstable flow	>35-55
E = unstable flow	>55-80
F = forced or breakdown	>80

3.2 Two-way STOP-controlled

The two way stop controlled (TWSC) traffic operation is defined is the uncontrolled intersections with the stop control on the minor street. At TWSC intersections, minor street are stop-controlled approaches and major street are not controlled by control signs. In a standard three-leg intersection, single minor street approach is controlled by a stop sign. In three-leg intersections, two of the approaches are controlled by a stop signs are a special form of controlled intersection control [Mathew T. V., 2014].

Potential capacity; requires conflicting flow rate $v_{c,x}$, the critical headway $t_{c,x}$, and the follow-up headway $t_{f,x}$, for movement x. It is computed according to gap acceptance model.

$$c_{p,x} = v_{c,x} \frac{e^{-v_{c,x}t_{c,x}/3,600}}{1 - e^{-v_{c,x}t_{f,x}/3,600}} \quad (6)$$

where

$c_{p,x}$ = potential capacity of movement x (veh/h);

$v_{c,x}$ = conflicting flow rate for movement x (veh/hr);

$t_{c,x}$ = critical headway for minor movement x (s);and

$t_{f,x}$ = follow-up headway for minor movement x(s).

Moment capacity;

I. Rank 1; major movement is assumed to be unconstrained by any movements of lower rank. A major street movement of Rank 1 is not expected to incur delay or slows the travel through the TWSC intersection.

II. Rank 2; movements are left turns and u-turns from the major street and right turns from the minor street, must yield to conflicting major-street through and right-turning vehicular movements of Rank 1. Minor street right turn is assumed to yield to major –street U-turns sometimes vice-versa.

a) The movement capacity of Rank 2 major street left turn movements (1 and 4) is equal to potential capacity;

$$c_{m,j} = c_{p,j} \quad (7)$$

b) The movement capacity of Rank 2 minor street right turns movements (9 and 12) is equal to its potential capacity;

$$c_{m,j} = c_{p,j} \quad (8)$$

III. Rank 3; minor-street traffic movements are minor-street through movements at four-leg intersections and minor-street left turns at three-leg intersections, must yield to conflicting Rank 1 and Rank 2 movements. Movement capacity $c_{m,k}$ for all rank movements can be calculated firstly by computing capacity adjustment factor that accounts for the impeding effects of higher ranked movements. The capacity adjustment factor is denoted by f_k for all rank 3 movements.

$$f_k = \prod_j p_{0,j} \quad (9)$$

where

$p_{0,j}$ = probability that conflicting Rank 2 movement j will operate in a queue-free state

k = Rank 3 movements.

The movement capacity for Rank 3 minor-street movements are calculated with equation below:

$$C_{m,k} = (c_{p,k})f_k \quad (10)$$

IV. Rank 4; movements occur only at four-leg intersections. Rank 4 movements are minor street turning left at four-leg intersection which can be hindered by all higher-ranked movements (Ranks 1, 2 and 3). The equation below shows the adjustment to the major street turning left, minor-street through impedance factor for Rank 4 movements.

$$p' = 0.65p'' - \frac{p''}{p'' + 3} + 0.6 \sqrt{p''} \quad (11)$$

where

p' = adjustment to the major-street left, minor-street through impedance factor;

$p'' = (p_{0,j})(p_{0,k})$;

$p_{0,j}$ = probability of queue free state for the conflicting major-street left turning traffic;
and

$p_{0,k}$ = probability of queue-free state for the conflicting minor-street crossing traffic.

The movement capacity $c_{m,l}$ can be adjusted by capacity adjustment factor which accounts for the impeding effects of higher ranked movements. The capacity adjustment factor for the Rank 4 minor-street left-turn movements are computed by equation below.

$$f_{p,l} = (p')(p_{o,j}) \quad (12)$$

where

l = minor-street left-turn movement of Rank 4 (Movements 7 and 10);

j = conflicting Rank 2 minor –street right-turn movement (Movements 9 and 12).

The movement capacity for the minor-street left turn movements of Rank 4 is determined by equation below where $f_{p,l}$ is the capacity adjustment factor that accounts for the impeding effects of higher ranked movements.

$$c_{m,l} = (c_{p,l})f_{p,l} \quad (13)$$

Final capacity adjustments; when several movements share the same lane and cannot be stopped by stop line; shared lane capacity is computed by the equation below.

$$C_{SH} = \frac{\sum_y v_y}{\sum_y \left(\frac{v_y}{c_{m,y}} \right)} \quad (14)$$

Movement control delay; is defined as the total time from the time a vehicle stops at the end of queue to the time vehicle departs from the stop line. The delay by motorist is affected by number of factors, control type, geometry, traffic demand flow and movements.

Average control delay for any minor movement is a function of capacity of approach and the degree of saturation. The recommended analysis period is 15 minutes.

The constant 5 s/veh account for the deceleration of vehicles from free flow speed, speed of vehicles in queue and the acceleration of vehicles from stop line to free flow speed.

$$d = \frac{3600}{c_{m,x}} + 900T \left[\frac{v_x}{c_{m,x}} - 1 + \sqrt{\left(\frac{v_x}{c_{m,x}} - 1\right)^2 + \frac{\left(\frac{3600}{c_{m,x}}\right)\left(\frac{v_x}{c_{m,x}}\right)}{450T}} \right] + 5 \quad (15)$$

where

d = control delay (s/veh);

v_x = flow rate for movement x (veh/h);

$c_{m,x}$ = capacity of movement x (veh/h); and

T = analysis time period (15-min period).

Approach and intersection control delay; the control delay for all vehicles on a particular approach can be computed as the weighted average of the control delay for each approach.

$$d_A = \frac{d_r v_r + d_t v_t + d_l v_l}{v_r + v_t + v_l} \quad (15)$$

where

d_A = control delay on the approach (s/veh);

d_r, d_t, d_l = computed control delay for the right-turn (r), through (t), and left-turn (l) movements, respectively (s/veh); and

v_r, v_t, v_l = volume or flow rate of right-turn (r), through(t), and left turn(l) traffic on the approach, respectively (veh/h).

Intersection control delay can be computed

$$d_I = \frac{d_{A,1} v_{A,1} + d_{A,2} v_{A,2} + d_{A,3} v_{A,3} + d_{A,4} v_{A,4}}{v_{A,1} + v_{A,2} + v_{A,3} + v_{A,4}} \quad (16)$$

where

$d_{A,x}$ = control delay on approach x (s/veh); and

$v_{A,x}$ = volume or flow rate on approach x (veh/h).

95th Percentile queue lengths; is an important consideration at un-signalized intersections. Queue length is a function of capacity of movement and volume of traffic for the analysis period for any minor movement of un-signalized intersection. 95th percentile queue length for any minor movement is computed using peak 15-min period for un-signalized intersection.

$$Q_{95} \approx 900T \left[\frac{v_x}{c_{m,x}} - 1 + \sqrt{\left(\frac{v_x}{c_{m,x}} - 1\right)^2 + \frac{\left(\frac{3,600}{c_{m,x}}\right)\left(\frac{v_x}{c_{m,x}}\right)}{150T}} \right] \left(\frac{c_{m,z}}{3,600}\right) \quad (17)$$

where

Q_{95} = 95th percentile queue (veh);

v_x = flow rate for movement x (veh/h);

$c_{m,x}$ = capacity of movement x (veh/h); and

T = analysis time period (0.25h for a 15-min period) (h).

Level of service; for a TWSC intersection is determined by the computed or measured delay. For motor vehicles, *LOS* determined for each minor-street movement as well major street left turns. *LOS* is not defined for the intersection as a whole for three main reasons:

- major street through vehicle are assumed to experience zero delay;
- the disproportionate number of major-street through vehicles a typical TWSC intersection which results in a very low overall average delay for all vehicles due to weighted average of all movements; and
- low delay can cover the importance of *LOS* deficiencies for minor movements.

The level of service can be categorized by delay and degree of saturation as shown in Table 3.2.

Table 3-2 Criteria that HCM adapts in assessing the level of service (*LOS*), Source:[5]

Delay (s/veh)	<i>LOS</i> by Volume-to-Capacity Ratio	
	$v/c \leq 1.0$	$v/c \geq 1.0$
0-10	<i>A</i>	<i>F</i>
>10-15	<i>B</i>	<i>F</i>
>15-25	<i>C</i>	<i>F</i>
>25-35	<i>D</i>	<i>F</i>
>35-50	<i>E</i>	<i>F</i>
>50	<i>F</i>	<i>F</i>

4 ANALYSIS OF INTERSECTION DONJE-SVETICE AND PLANINSKA STREET

Donje-Svetice and Planinska Street is located in the eastern part of the City of Zagreb (Croatia) with the co-ordinates of 45.809420 North and 16.013947 East. Urban intersection is surrounded with residential areas, commercial building as well as an industry. Intersection is connected with the Kneza Branimira and Grad Vukovara Street. Traffic flow during the rush hours creates long queue of vehicles along the Planinska Street East and West. In an existing intersection, traffic signs are inappropriately used. Yield sign is found on major-street where as in minor-street no traffic sign of stop or yield is found which can lead to traffic accidents in current and in future when there is a cutoff of electricity.

4.1 Basic layout parameters

The main objective is to examine the general characteristics of the intersection and determine the most feasible design solution for optimization of traffic congestion. An aerial overview on Figure 4-1 gives disposition of the intersection and the surrounding area, which helped in planning the feasible solutions considering the environment around the intersection. *In situ* studies are conducted to know the existing layout parameters, location and cycle length of traffic light signalization, traffic signs and equipment, and movement of traffic demand flows. In the right hand corner of the Figure 4-1 the area within the red rectangle is the studied area of Donje-Svetice and Planinska Street intersection. Its major intersection is four-legged intersection of Donje-Svetice and Planinska Street (A) whereas minor t-intersection is of Planinska, Square Volovcica and Ivanicgradska Street (B). Intersection A is shown in Figure 4-2 and Figure 4-3. Intersection B is shown in Figure 4.4 and Figure 4.5.

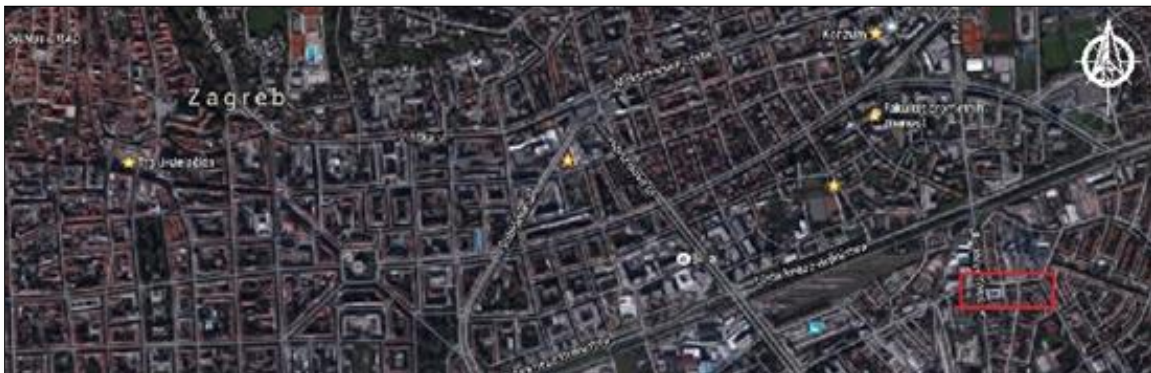

Figure 4-1 Aerial view of site layout, Source: [7]



Figure 4-2 Intersection view: a) Donje-Svetice Street North, b) Donje-Svetice Street South



Figure 4-3 Intersection view: a) Planinska Street West; b) Planinska Street East



Figure 4-4 Intersection view: a) Square Volovcica Street; b) Planinska Street



Figure 4-5 Ivanicgradska Street

4.2 Existing design

Intersection **A** is the major intersection with the congestion on the Planinska Street East on rush hours. Intersection **A** connects Kneza Branimira and Grada Vukovara Street which connects to the core of the City. Intersection **A** is the main intersection which connects Borongajska Cesta Street. Borongajska Cesta Street connects residential areas, educational areas and commercial areas. Intersection **A** is shown below in Sheet I. Intersection **B** is the minor intersection which affects the intersection **A** leading to congestion on the Planinska Street East. Intersection **B** connects the Grada Vukovara and Borongajska Cesta Street connecting residential, educational and commercial areas. Intersection **A** is shown below in Sheet I.

4.3 Traffic volume

In road traffic engineering it is a common procedure to study movement and structure of traffic demand flow on roads and intersection. The most commonly used unit is vehicles per hour (veh/h). It includes recording the volume of various types and classes of traffic and distribution by direction and turning movements. Different vehicles classes are converted to common standard unit Passenger Car Unit (PCU). It's needed for planning, designing and regulation phases of traffic in establishing priorities and schedules of traffic improvements.

The red circle below in a Figure 4.6 shows a location where traffic volume count survey was conducted on morning session of 9th February 2016 from 07:00-09:00. Traffic counting slip is shown in Appendix 11.

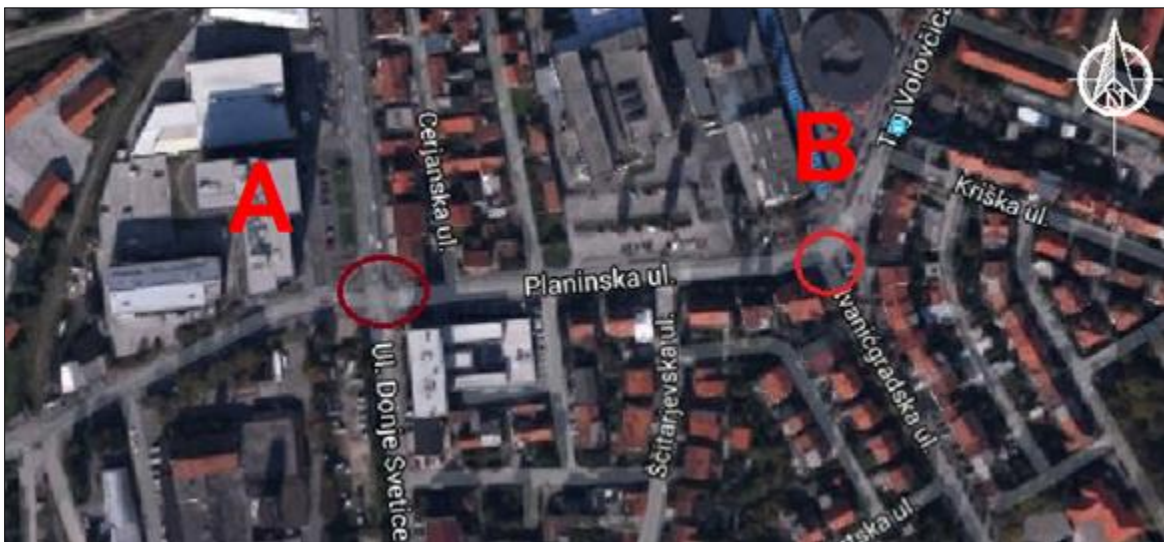

Figure 4-6 Proposed study areas on Donje-Svetice and Planinska Street, Source: [7]

Traffic volume count is done manually on intersection Donje-Svetice and Planinska Street during morning session with 15 min interval for 2 hours. The session having maximum traffic volume count is shown below in Figure 4.7 and traffic flow pattern of the intersection in Figure 4.8.

In intersection A, approach Donje-Svetice Street North has the highest PCU of 758.5 veh/h and approach Planinska Street West has lowest PCU of 384 veh/h. Annual average daily traffic (AADT) of 2016 are 7585 veh/h for approach Donje-Svetice Street North, 6715 veh/h for approach Donje-Svetice Street South, 3840 veh/h for approach Planinska Street West and 4655 veh/h for approach Planinska Street East. Approach Donje-Svetice Street North has 33.27% and approach Planinska Street West has 16.85% of PCU of total volume of PCU.

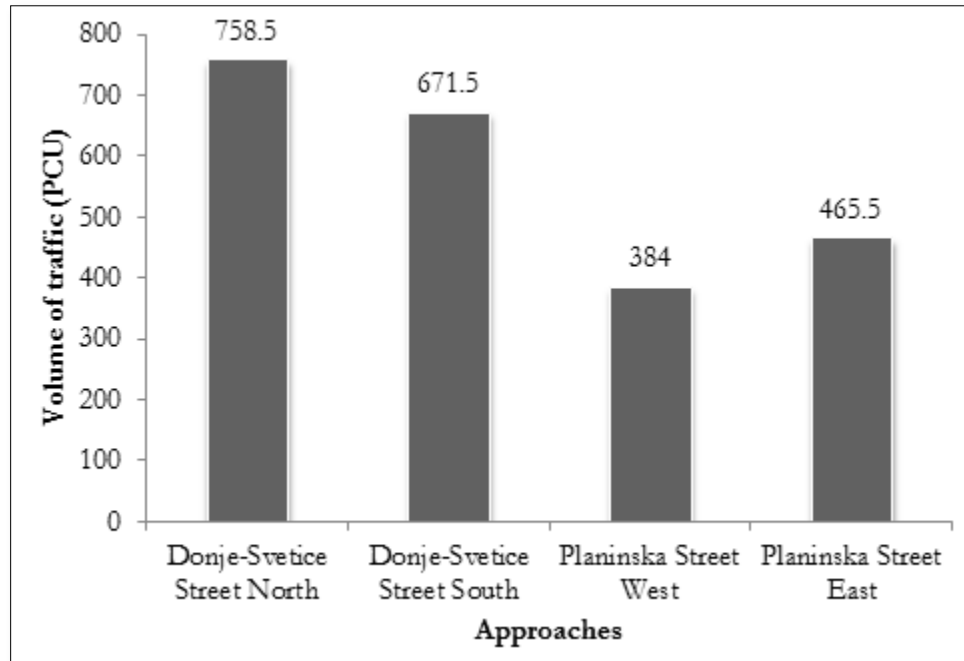

Figure 4-7. Volume of traffic in PCU for intersection A

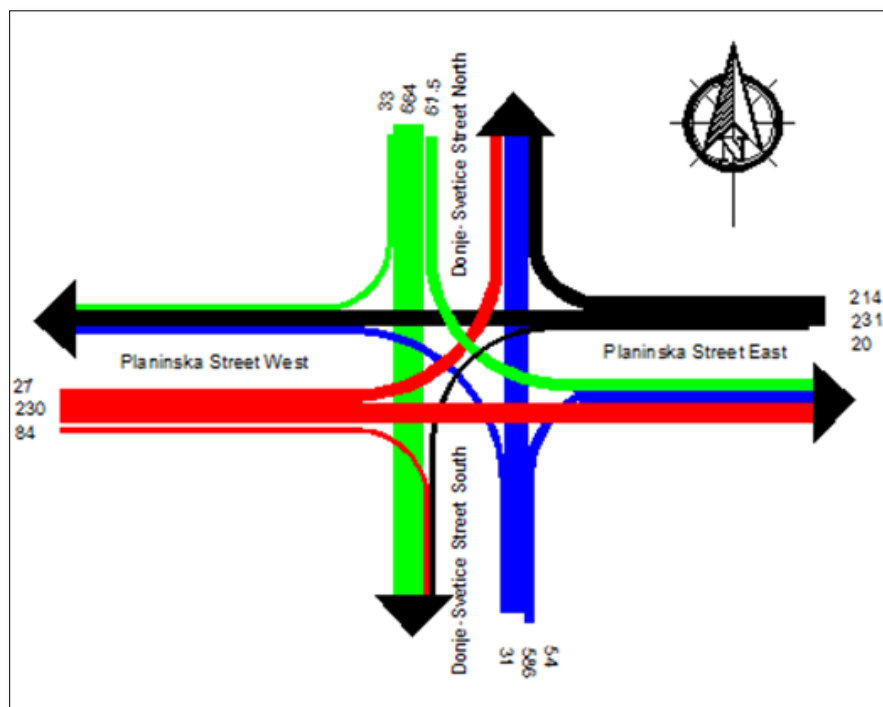

Figure 4-8. Traffic flow pattern in PCU for intersection A

Traffic volume for T-intersection is shown below in Figure 4.9 and traffic flow pattern of the T-intersection in Figure 4.10. Approach Square Volovcica Street has highest PCU of 465.5 veh/h and approach Ivanicgradska Street has lowest PCU of 116 veh/h. Annual average daily traffic (AADT) of 2016 are 4650 veh/h for approach Square Volovcica Street, 3460 veh/h for approach Planinska Street and 1160 veh/h for approach Ivanicgradska Street. Approach Square Volovcica Street has 50.19% and approach Ivanicgradska Street has 12.51% of PCU of total volume of PCU.

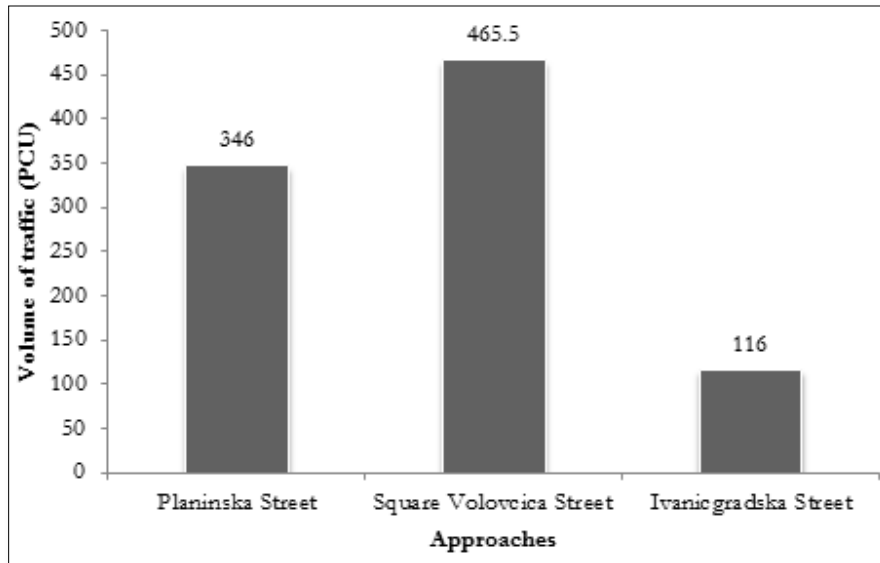

Figure 4-9 Volume of traffic in PCU for intersection *B*

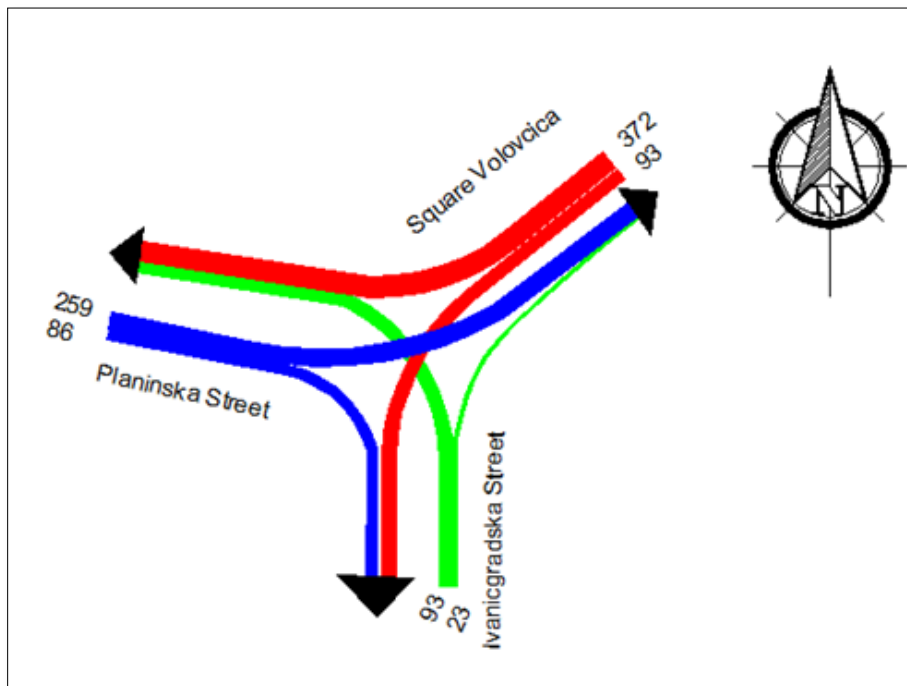

Figure 4-10 Traffic flow pattern in PCU for intersection *B*

5 DESIGN VARIANTS PROPOSAL

Previous described studies have led to three geometry design variants of intersection **A** (Donje-Svetice and Planinska Street) and one variant for intersection **B** (Planinska, Square Volovcica and Ivanicgradska Street).

The design variants of intersection **A** are:

1. **Variant VA_I.**: introduction of three phase traffic signal plan.
2. **Variant VA_II.**: re-routing of the right hand traffic of Planinska Street East through Scitarjevaska Street and Vugrovecka Street.
3. **Variant VA_III.**: addition of one traffic lane on Planinska East and Donje-Svetice North Street.

The design variants of intersection **B** is

1. **Variant VB_I.**: introduction of traffic signal plan.

a) Variant VA_I.

Introduction of three phase signal plan for the existing intersection VA_0 with appropriate sign for major street with priority-road sign (C08) and minor street with yield sign (B01). Introduction of appropriate traffic sign which improves the traffic capacity and safety of the intersection.

b) Variant VA_II.

De-tour/re-route of the right hand traffic of approach Planinska Street East (number of approach) through Scitarjevaska Street and Vugrovecka Street to approach Donje-Svetice Street North improves the traffic efficiency, safety of traffic and decreases the queuing time for vehicles.

c) Variant VA_III.

Addition of traffic lane on approach Donje-Svetice Street North and approach Planinska Street East with a lane width of 3 m and 2.75 m with three-phase of traffic signal plan. It could improve the level of service of the intersection with increase in capacity of intersection and level of traffic safety.

d) Variant VB_I.

The introduction of traffic signal plan replacing the current two way stop control. Introduction of signal plan could improve the level of service of intersection for times to come.

- **Auto TURN** is the vehicle swept path analysis software of choice for transportation engineers, architects and planners worldwide. Auto TURN is used to analyze road and site design projects including intersections, roundabouts, bus terminals, loading bays, parking lots or any on/off-street assignments involving vehicle access checks, clearances and swept path maneuvers. Auto TURN improves the user experiences by creating a direct relationship between simulations and CAD geometry enhancing the quality of overall design. Auto TURN is an asset to any design involving vehicles access, clearances and maneuverability. Auto TURN has been developed by transportation professionals for transportation professionals and backed by rigorous engineering and regular field tests. Auto TURN is referred by AASTHO (American Association of State Highway and Transportation Officials), FHWA (Federal Highway Administration) and leading Department of Transportation as it provides safety, accessibility and social, economic and environmental impact.

The design variants are simulated for driving maneuvers with Heavy truck CO (FSGV 2001(DE)) in an Auto TURN and design variants are designed according to the simulated driving maneuvers. The vehicle used in Auto TURN for simulating is shown in Figure 5.1. For the variant VA-VII, the lane width from 3 m to 3.75 m for Scitarjevska Street and lane width from 2.75 m to 3.5 m for Vugrovecka Street.

For the variant VA-VIII, outbound lane width for Donje-Svetice Street North increased from 3 m to 3.25 m, outbound lane width for the Planinska Street West increased from 3 m to 3.75 m and outbound lane width for the Donje-Svetice Street South from 3 m to 3.25 m.

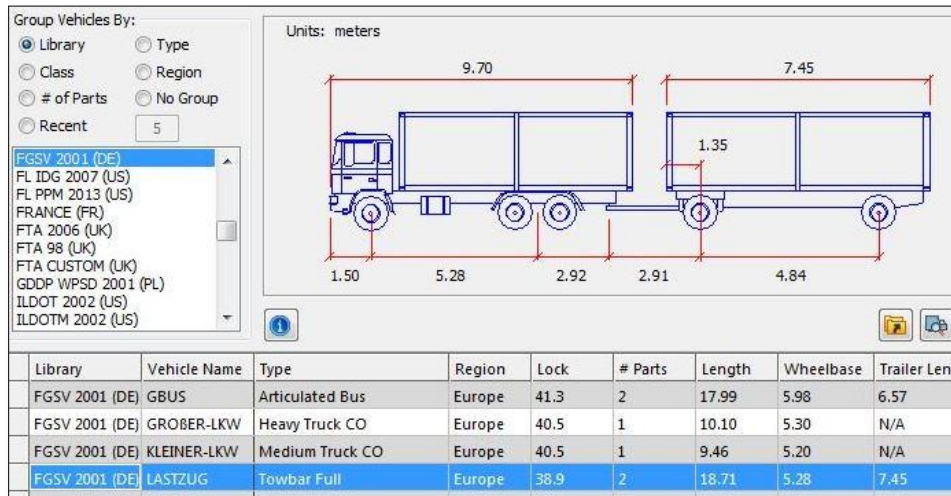

Figure 5-1 Vehicle used in auto TURN, Source:[15]

6 FUNCTIONAL EFFICIENCY OPTIMIZATION

The SIDRA intersection software is an advanced micro-analytical tool for evaluation of alternative intersection designs in terms of capacity, level of service and a wide range of performance measures including delay, queue length and stops for vehicles and pedestrians as well as fuel consumption, pollutant emissions and operating cost (Akmaz & Celik, 2016). Sidra intersection is recognized by the Highway Capacity Manual, Transport Research Board and others.

Intersection **A** and **B** is analyzed with the help of SIDRA INTERSECTION tool with input data such as intersection movement definitions, lane geometry and lane data, priorities, vehicle movement data and phasing and timing. The control delay and level of service results from SIDRA are obtained and propose the optimal geometry design variant for each intersection.

6.1 Variant VA_O.

In SIDRA, the existing intersection **A** is analyzed using the traffic volume data conducted on morning session which has the highest AADT (Chapter 4). It is shown in Figure 4.7.

• **Signal phasing;** Signal phase is a state of the signals during which one or more movements receive right of way. The existing intersection has two-phase signal plan with cycle time of 90 seconds. Intersection signal plan is pre-timed. The phase diagram for the existing intersection is shown below in Figure 6.1. All the North-South movements occur in Phase A and all the East-West movements occur in phase B1. Effective green time allocated for phase A is 51 sec and 31 sec for phase B1 respectively with uniform clearance time of 3 sec. Movement timing is shown in Appendix 1.

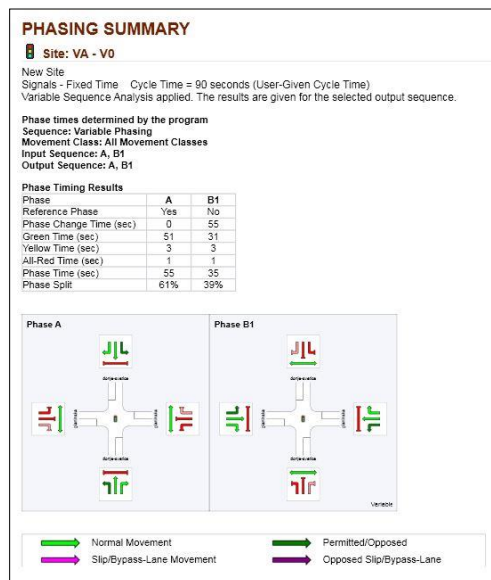

Figure 6-1 Signal phasing of VA_O.

• **Degree of saturation;** approach Planinska Street West has the lowest degree of saturation of 0.59 and approach Donje –Svetice Street North with the highest degree of saturation of 0.80 of all approaches. Intersection degree of saturation is 0.80 which shows intersection is operating under capacity without experiencing the excessive delays. Degree of saturation is shown in Figure 6.2.

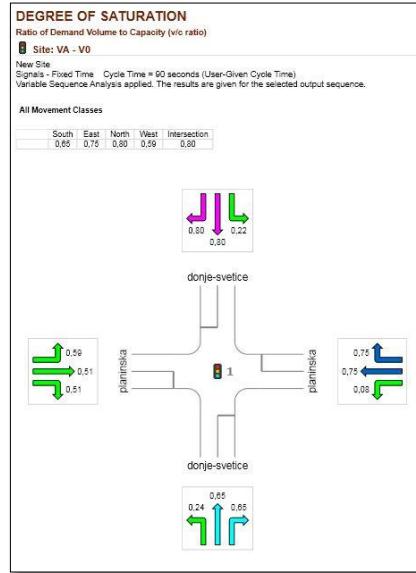

Figure 6-2 Degree of saturation of VA_O.

• **Control delay;** approach Planinska Street West has the highest delay of 27.9 s/veh. and approach Donje-Svetice Street South with the lowest delay with 15.8 s/veh. The delay for the intersection is 21.5 s/veh. LOS of intersection is C. Delay is shown in Figure 6.3.

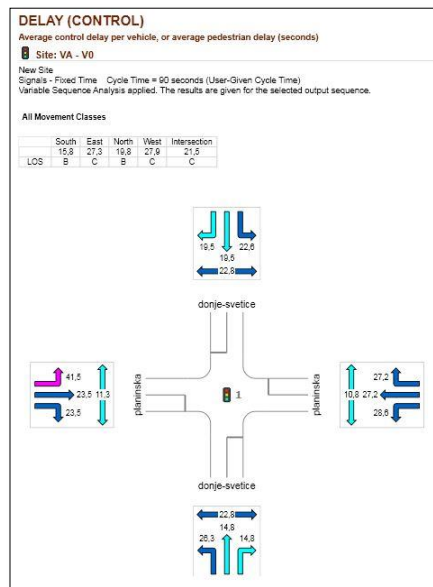

Figure 6-3 Delay of VA_O.

- **Level of service;** LOS of approach Planinska Street West and East is *C* whereas for approach Donje-Svetice South and North is *B*. Therefore LOS of the intersection is *C* which states its flow of traffic is stable. LOS is shown in Figure 6.4.

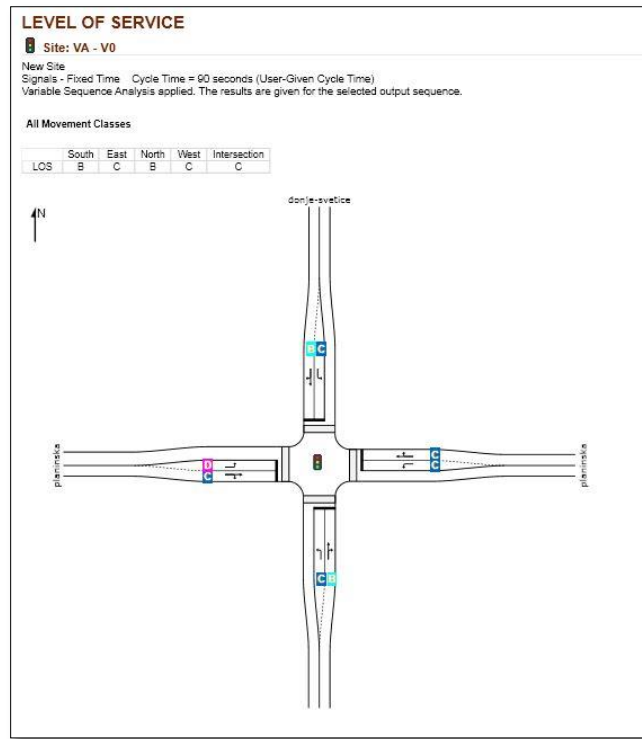

Figure 6-4 Level of service of VA_O.

6.2 Variant VA_I.

The Variant VA_I. is supplemented with three phase signal plan to the existing two phase signal plan of the intersection. All the traffic movement from approach Donje-Svetice Street is grouped in first phase and traffic movements of approach Planinska Street in second phase. In a third phase, the right-turn traffic movement from approach Planinska East Street and all traffic movement from approach Donje-Svetice North Street are grouped.

- **Signal phasing;** Intersection has three-phase signal plan with the cycle time of 90 seconds. Intersection is pre-timed. The phase diagram of the intersection is shown below in Figure 6.5. All the North-South movements occur in Phase A, all the East-West movements occur in Phase B1 and a Phase C with a leading right turn from East approach and all movements of North approach. Green time for Phases is 37, 25 and 16 seconds. Clearance time is uniform for all phases of 3 seconds. Movement timing is shown in Appendix 2.

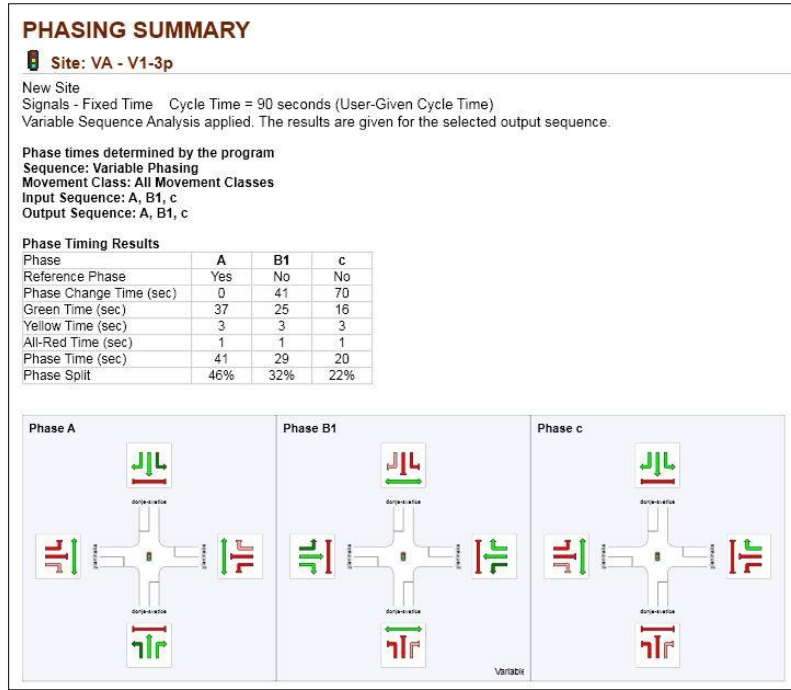

Figure 6-5 Signal phasing of VA_I.

• **Degree of saturation;** approach Donje-Svetice Street North has the lowest degree of saturation of 0.66 and approach Planinska Street West with the highest degree of saturation of 1.07 of all approaches. Intersection degree of saturation is 1.07 which shows intersection demand exceeds the available capacity with excessive delays and queuing. Degree of saturation is shown in Figure 6.6.

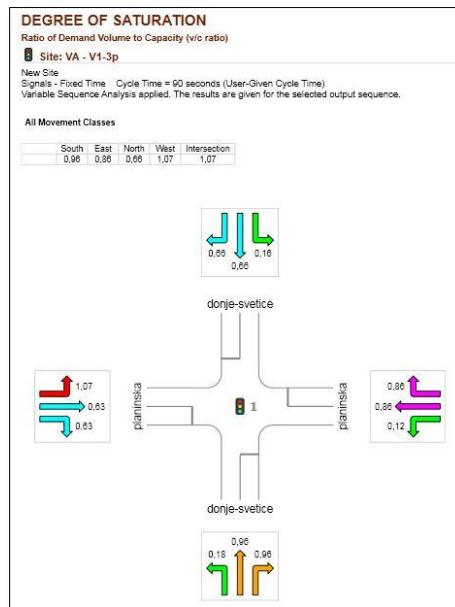

Figure 6-6 Degree of saturation of VA_I.

• **Control delay;** approach Planinska Street West has the highest delay of 62.1 s/veh and approach Donje-Svetice Street North has lowest delay of 11.8 s/veh. The delay for the intersection is 36.1 s/veh. *LOS* of intersection is *D*. Delay is shown in Figure 6.7.

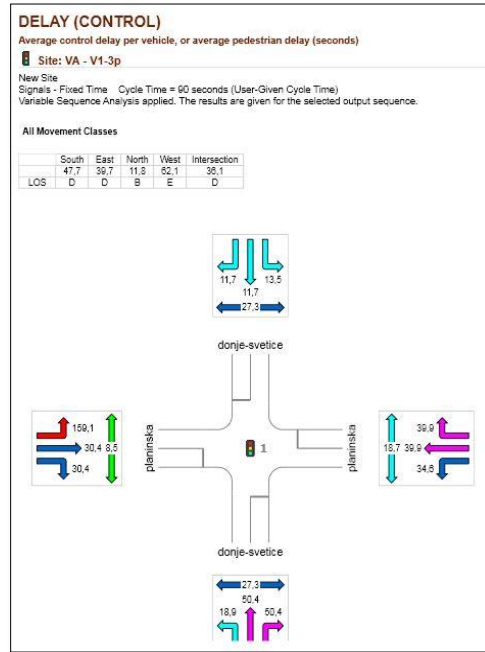

Figure 6-7 Delay of VA_I.

• **Level of service;** *LOS* for approach Planinska Street East and Donje-Svetice Street South is *D* whereas for approach Donje-Svetice North and Planinska Street West is *B*. Therefore *LOS* of intersection is *D* which states its flow of traffic is approaching unstable conditions. *LOS* is shown in Figure 6.8.

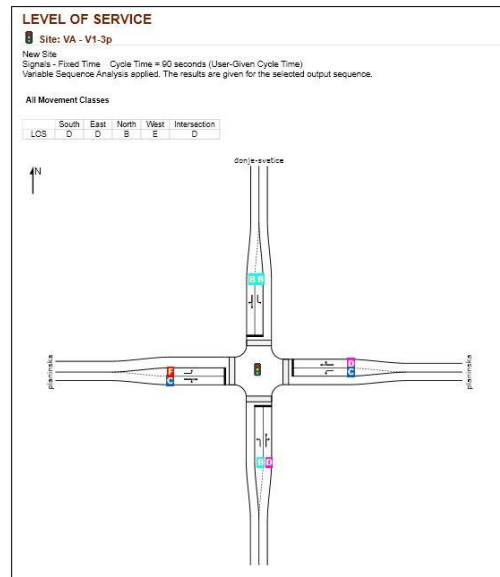

Figure 6-8 Level of service for the variant VA_I.

6.3 Variant VA_II.

Re-route of right hand traffic of approach Planinska Street East to approach Donje-Svetice Street North is introduced. In SIDRA Intersection, the traffic volume count survey data is used for analysis in which right hand traffic volume of approach Planinska street east is added to approach Donje-Svetice Street South through traffic movement.

- **Signal phasing;** All the North-South movements occur in Phase A and all the East-West movements occur in Phase B. Green time allocated is 58 and 24 seconds. Clearance time allocated is uniform for both the phases of 3 seconds. Signal phasing is shown in Figure 6.9. Movement timing is shown in Appendix 3.

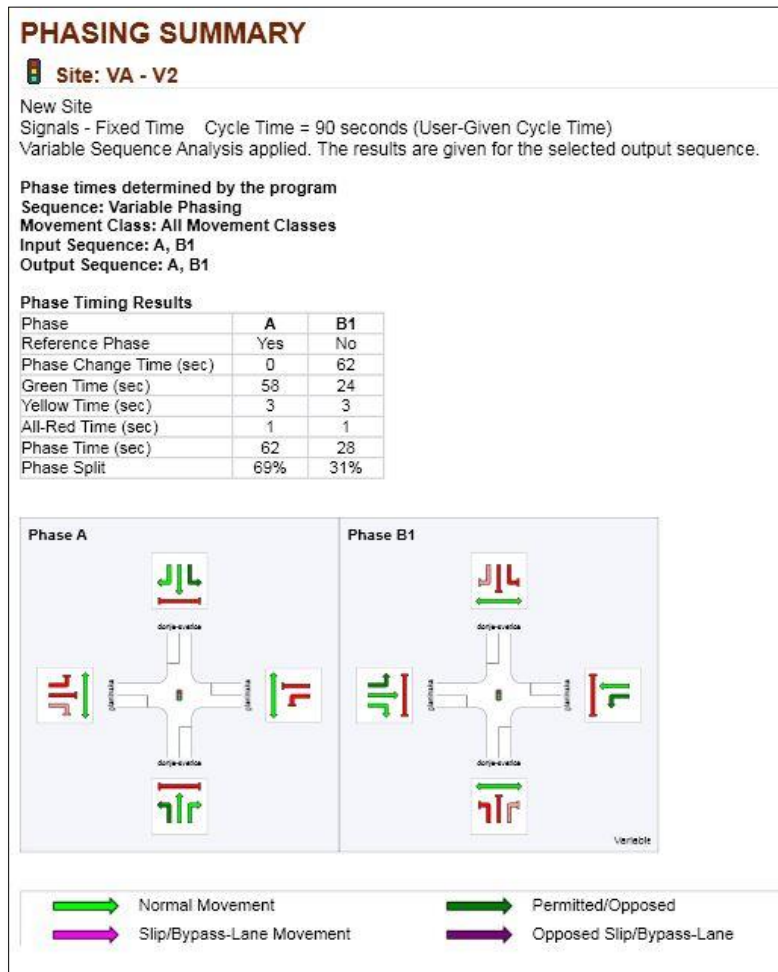

Figure 6-9 Signal phasing for VA_II.

• **Degree of saturation;** approach Planinska Street East has lowest degree of saturation of 0.46 and approach Donje-Svetice Street South with the highest degree of saturation of 0.79 of all approaches. Intersection degree of saturation is 0.79 which shows intersection is operating under capacity without experiencing excessive delay. Degree of saturation is shown in Figure 6.10

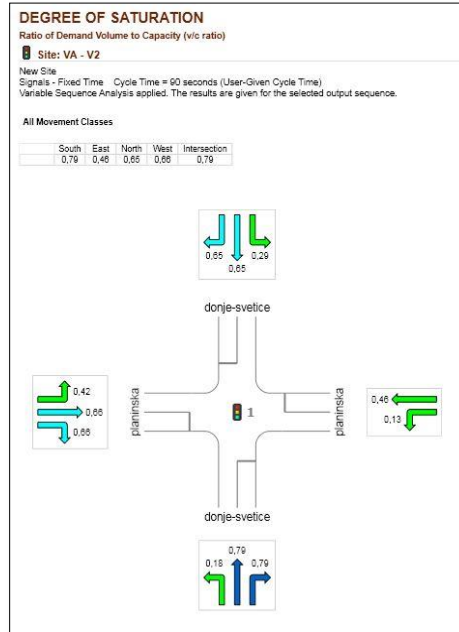

Figure 6-10 Degree of saturation for VA_II.

• **Control delay;** approach Planinska Street West has the highest delay of 32.7 s/veh.and approach Donje-Svetice Street North with the lowest delay of 12.1 s/veh. The delay for the intersection is 18.5 s/veh. LOS for intersection is B. Delay is shown in Figure 6.11.

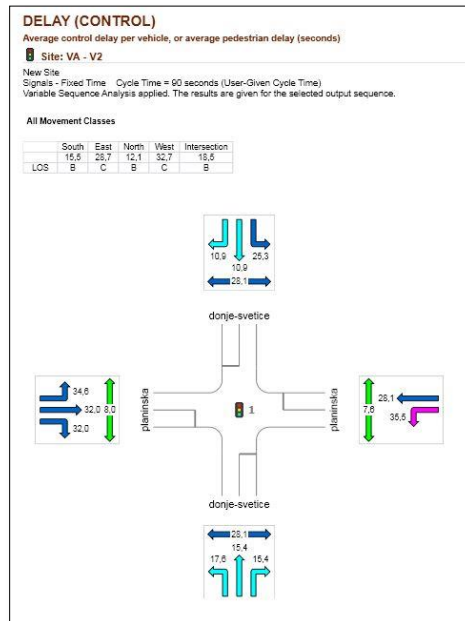

Figure 6-11 Delay for VA_II.

• **Level of service;** LOS of approach Planinska Street East and West is *C* whereas for approach Donje-Svetice North and South is *B*. Therefore LOS of intersection is *B* which states its flow of traffic is reasonably free. LOS is shown in Figure 6.12.

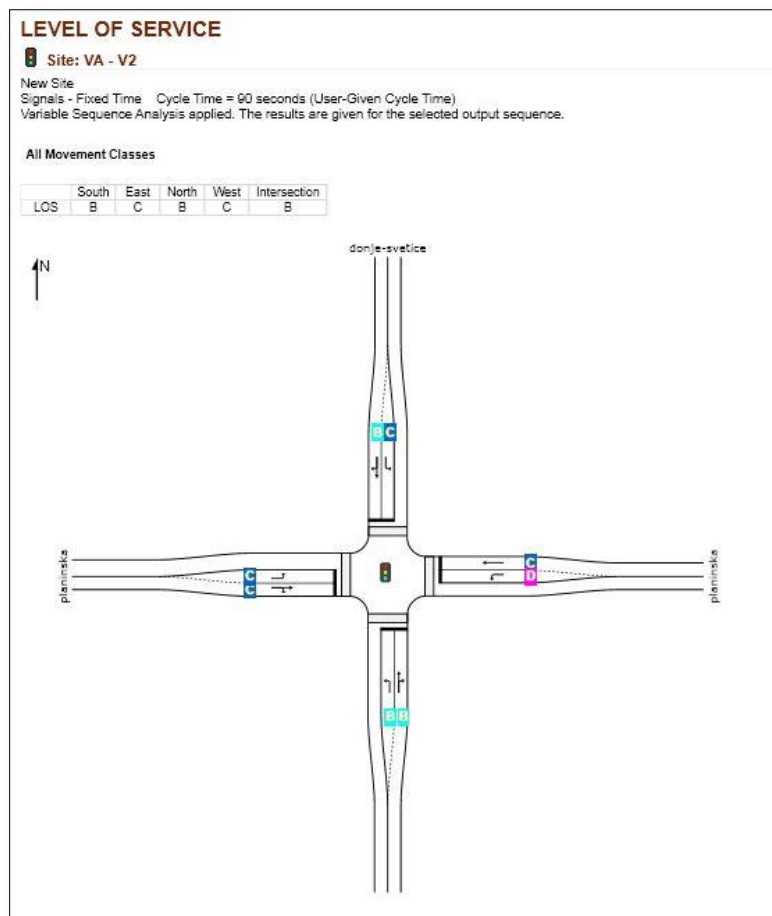

Figure 6-12 Level of service for VA_II.

6.4 Variant VA_III.

Approach Donje-Svetice North and Planinska East Street with addition of lane width of 3 m and 2.75 m with three phase traffic signal plan are introduced. It improves the level of service of the intersection with increase in capacity of intersection and level of traffic safety.

• **Signal phasing;** All the North-South movements occur in Phase A, all the East-West movements occur in Phase B1 and a Phase C with a leading right turn from approach Planinska Street East with all movements from approach Donje-Svetice Street North. Green time allocated is 49, 23 and 6 seconds for the phases. All phases have uniform clearance time of 3 seconds. Signal phasing is shown in Figure 6.13. Movement timing is shown in Appendix 4.

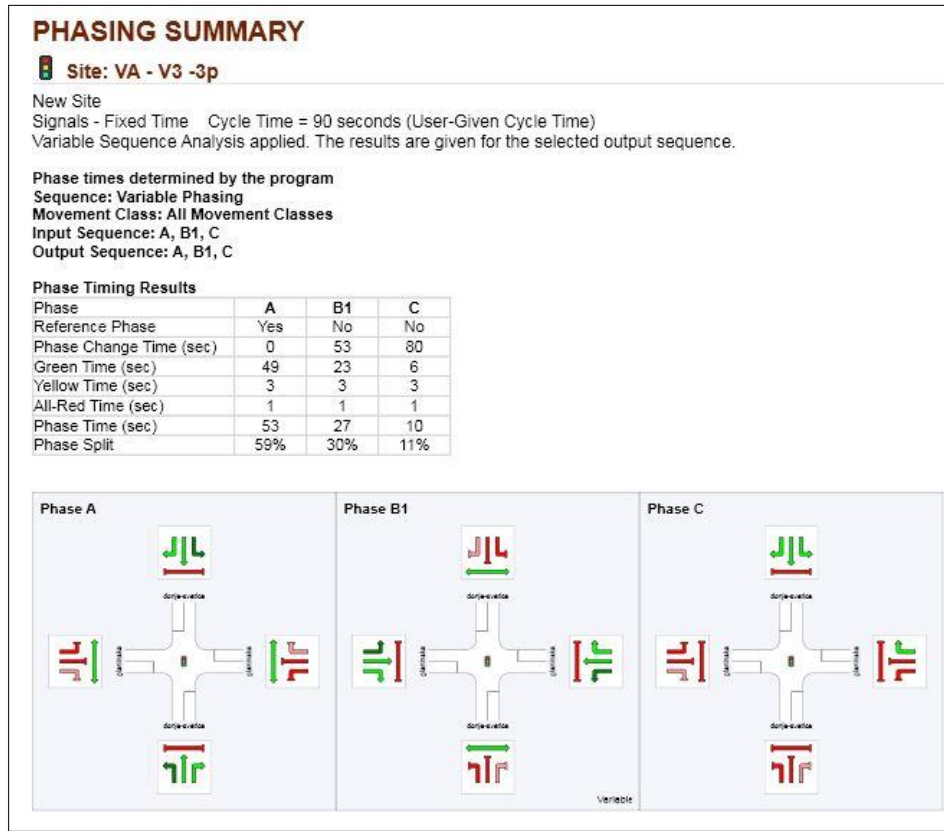

Figure 6-13 Signal phasing for VA_III.

• **Degree of saturation;** approach Planinska Street East has lowest degree of saturation of 0.50 and approach Donje-Svetice Street South with the highest degree of saturation of 0.69 of all approaches. Intersection degree of saturation is 0.69 which shows intersection is operating under capacity without experiencing excessive delays. Degree of saturation is shown in Figure 6.14.

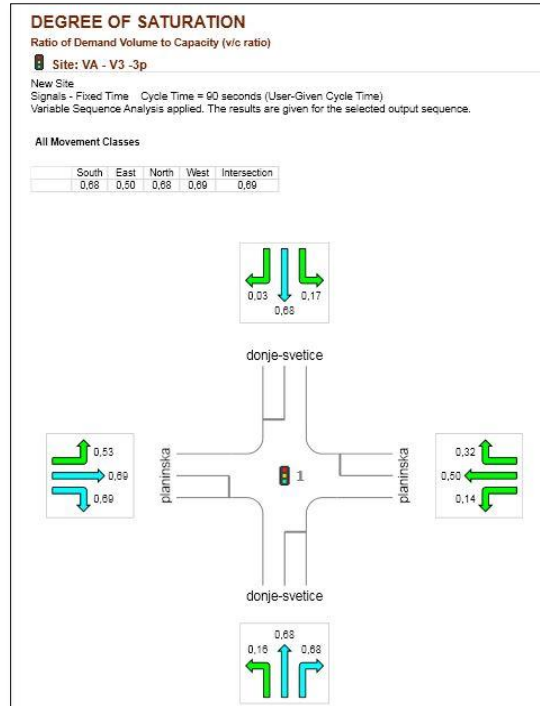

Figure 6-14 Degree of saturation for VA_III.

• **Control delay;** approach Planinska Street West has the highest delay of 34.8 s/veh and approach Donje-Svetice Street North with lowest delay of 10.1 s/veh. The delay for the intersection is 17.9 s/veh. *LOS* for intersection is *B*. Delay is shown in Figure 6.15.

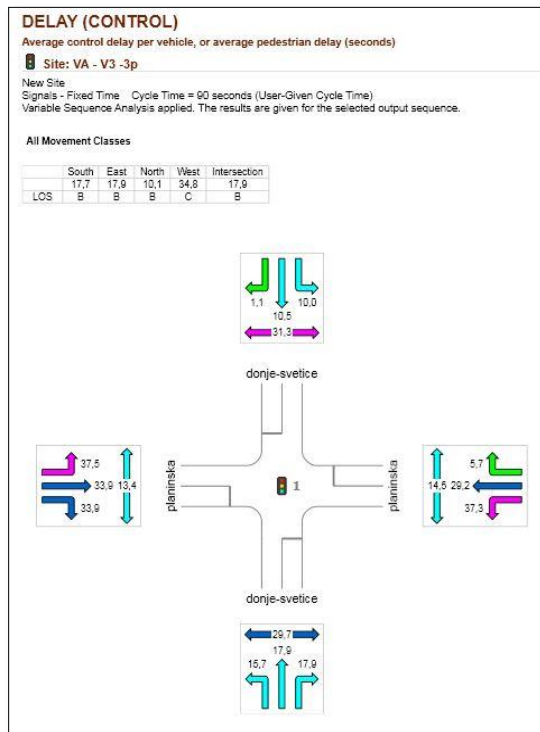

Figure 6-15 Delay for VA_III.

• **Level of service;** *LOS* of approach Planinska Street West is *C* whereas for approach Donje-Svetice North and South and Planinska Street East is *B*. Therefore *LOS* of intersection is *B* which states its flow of traffic is reasonably free. *LOS* is shown in Figure 6.16.

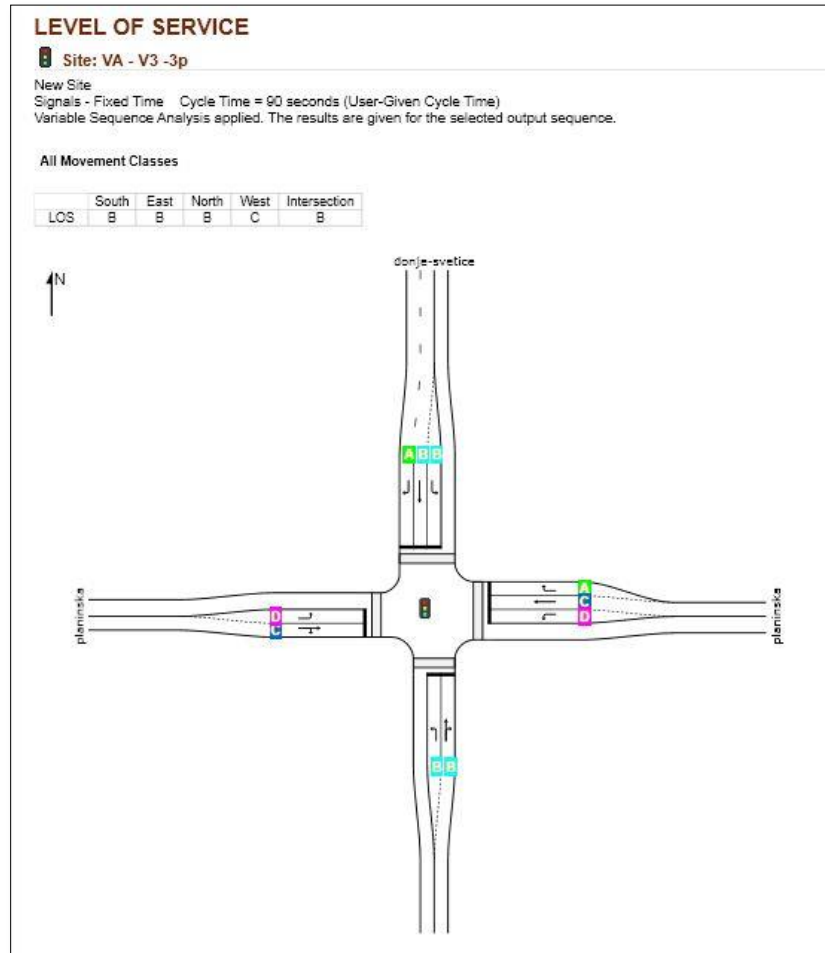

Figure 6-16 Level of service for VA_III.

6.5 Variant VB_O.

It's a two way stop control T-intersection adjacent to the four-legged Donje-Svetice and Planinska Street where the traffic flow is directly related to the volume of traffic on four-legged intersection. Approach Square Volovcica and Planinska Street have major traffic volume than the approach Ivanicgradska Street.

• **Degree of saturation;** approach Square Volovcica Street has the lowest degree of saturation of 0.21 and approach Ivanicgradska Street with the highest degree of saturation of 0.46 of all approaches. Degree of saturation for intersection is 0.46 which shows intersection is operating under capacity without experiencing excessive delays. Degree of saturation is shown in Figure 6.17.

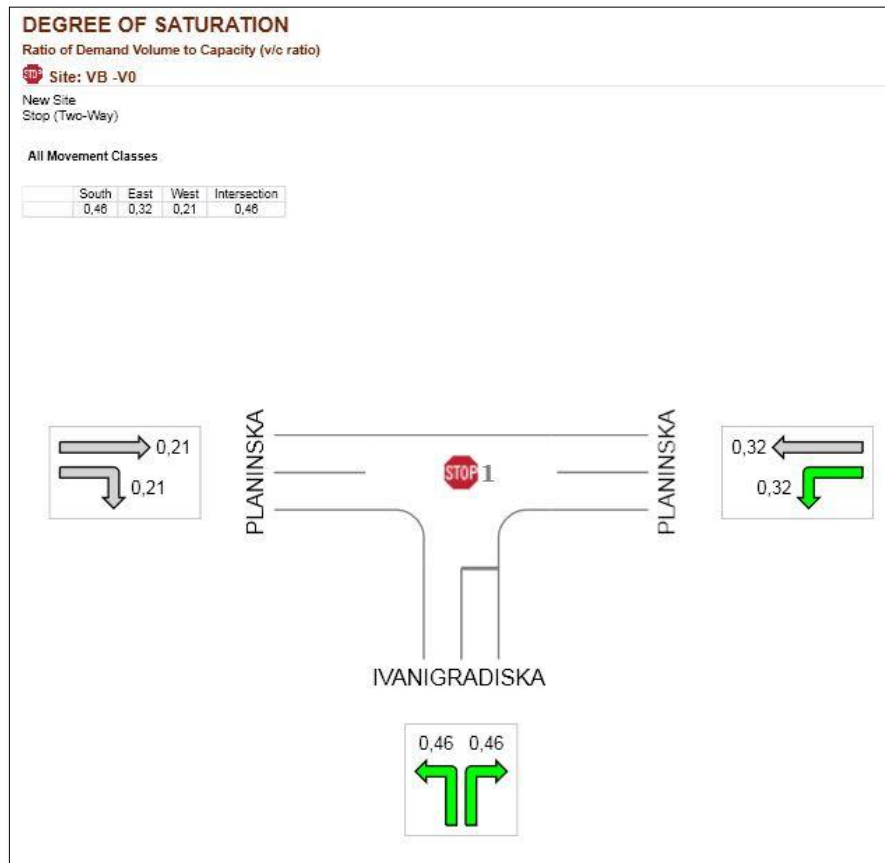

Figure 6-17 Degree of saturation for VB_O.

• **Control delay;** approach Ivanicgradska Street has the highest delay of 24.8 s/veh.and approach Square Volovcica Street with the lowest delay of 0.0 s/veh. The average delay for the intersection *B* is 4.7 s/veh. *LOS* for intersection is *A*. Delay is shown in Figure 6.18.

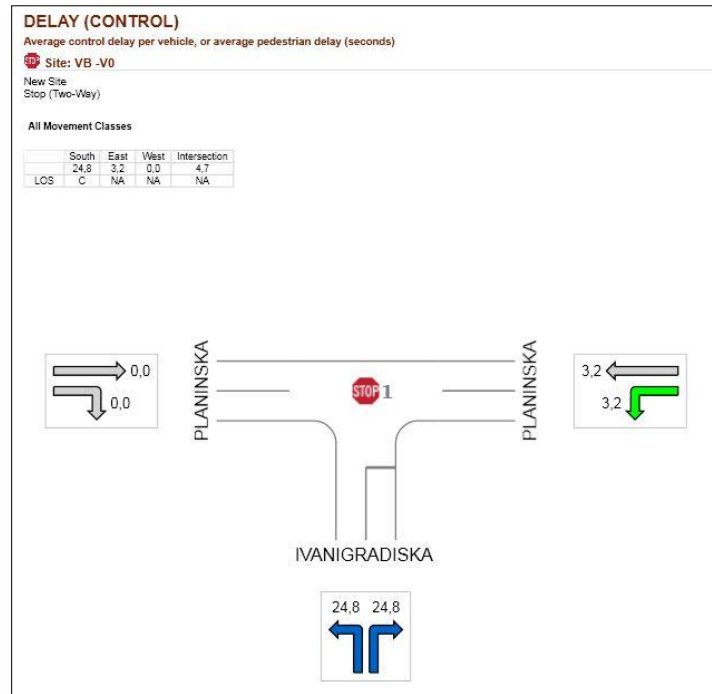

Figure 6-18 Delay for VB_O.

• *Level of service*; LOS of approach Ivanigradska Street is C whereas for approach Square Volovcica and Planinska Street is A. Therefore LOS of intersection is A. LOS is shown in Figure 6.19

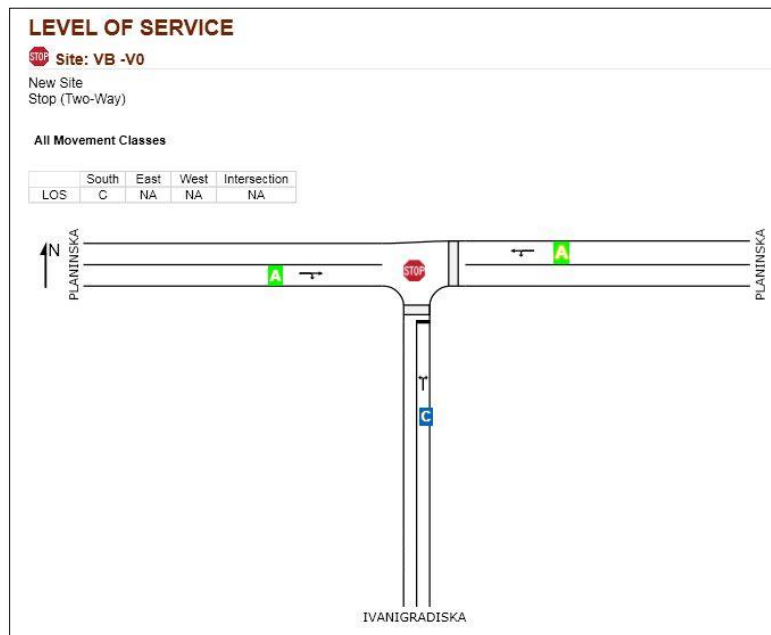

Figure 6-19 Level of service for VB_O.

6.6 Variant VB_I.

In a variant VB_I, two-phase signal plan is introduced replacing TWSC intersection to improve the traffic safety and capacity of the intersection.

• **Signal phasing;** Phase diagram for the T-intersection is shown below in Figure 6.20. All East-West movements are occurring in Phase B and all movements from South approach occur in Phase A. Green time is 15 and 67 seconds respectively for Phase A and Phase B. Clearance time is uniform for all phases of 3 seconds. Signal phasing is shown in Figure 6.20.

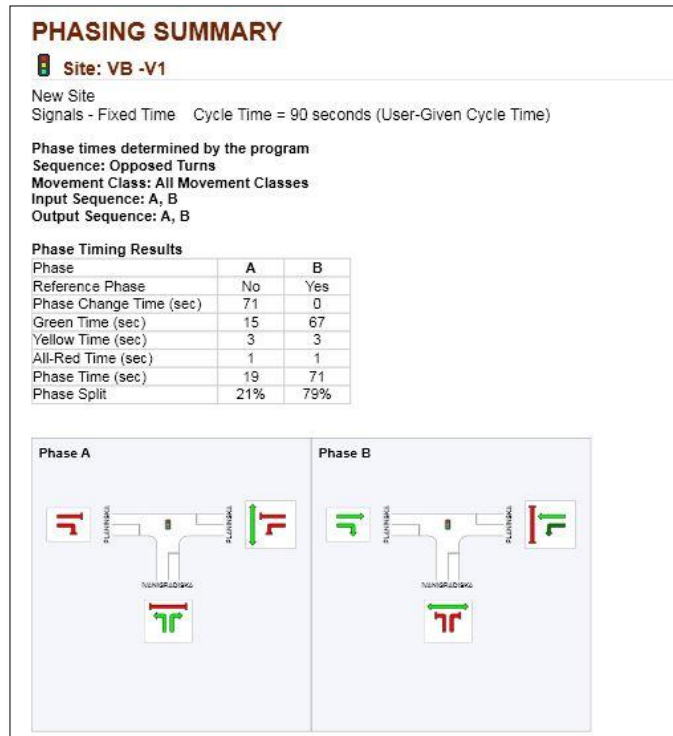

Figure 6-20 Signal phasing for VB_I.

• **Degree of saturation;** approach Square Volovcica Street has the lowest degree of saturation of 0.28 and approach Planinska and Ivanicgradska Street with the highest degree of saturation of 0.45 of all approaches. Degree of saturation for intersection is 0.45 which shows intersection is operating under capacity without experiencing excessive delays. Degree of saturation is shown in Figure 6.21.

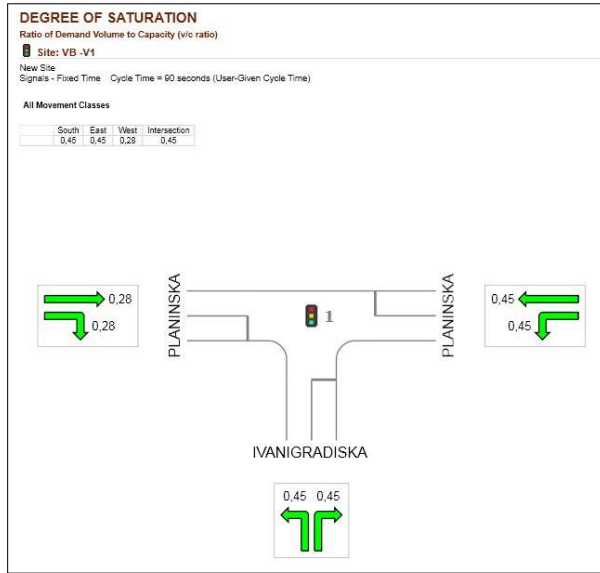

Figure 6-21 Degree of saturation for VB_I.

- **Control delay**; approach Ivanigradska Street has the highest delay of 34.6 s/veh and approach Square Volovcica with lowest delay of 3.8 s/veh. The delay for the intersection is 8.4 s/veh. *LOS* for intersection is A. Delay is shown in Figure 6.22.

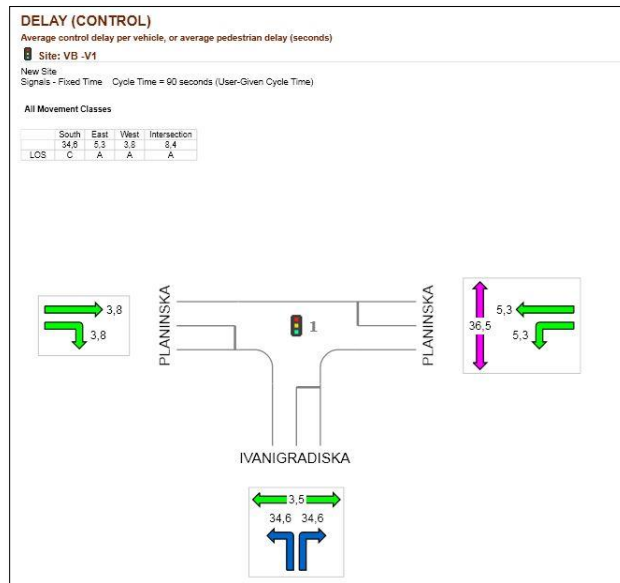

Figure 6-22 Delay for VB_I.

• **Level of service;** *LOS* of approach Ivanicgradska Street is *C* whereas for approach Planinska and Square Volovcica Street is *A*. Therefore *LOS* of intersection is *A* which states it's in free flow. *LOS* is shown in Figure 6.23.

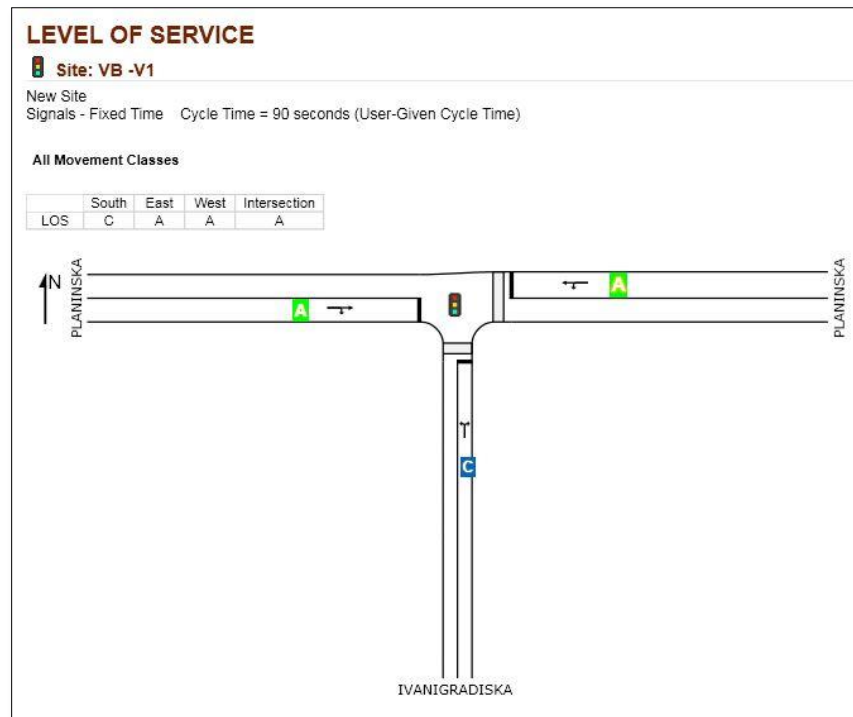

Figure 6-23 Level of service for VB_I.

6.7 Sensitivity analysis

- *Analysis of intersection for design period (20 years)*

Optimal design variant for studied intersection are selected for major and minor intersection. It is analyzed for designed period of 20 years. The best intersection is variant III of four-legged intersection and variant I from T-intersection. Sensitivity analysis, which assesses the effect of variations in input parameters on model outputs, has proven useful in financial applications, risk analysis and technical processes for evaluating the robustness of model solutions (Saltelli et al. 2008).

Variant VA_III.

• **Signal phasing;** for the design period of 20 years the intersection VA_III-3p-20 have three-phase signal plan with cycle time of 90 seconds. The phase diagram for the intersection is shown in Figure 6.24. All the North-South movements occur in Phase A, East-West movements occur in Phase B and a Phase C with a leading right-turn from East approach and movements from North approach. Green time is 51, 21 and 6 seconds for phases with a uniform clearance time/yellow time of 3 seconds. Movement timing is shown in Appendix 5.

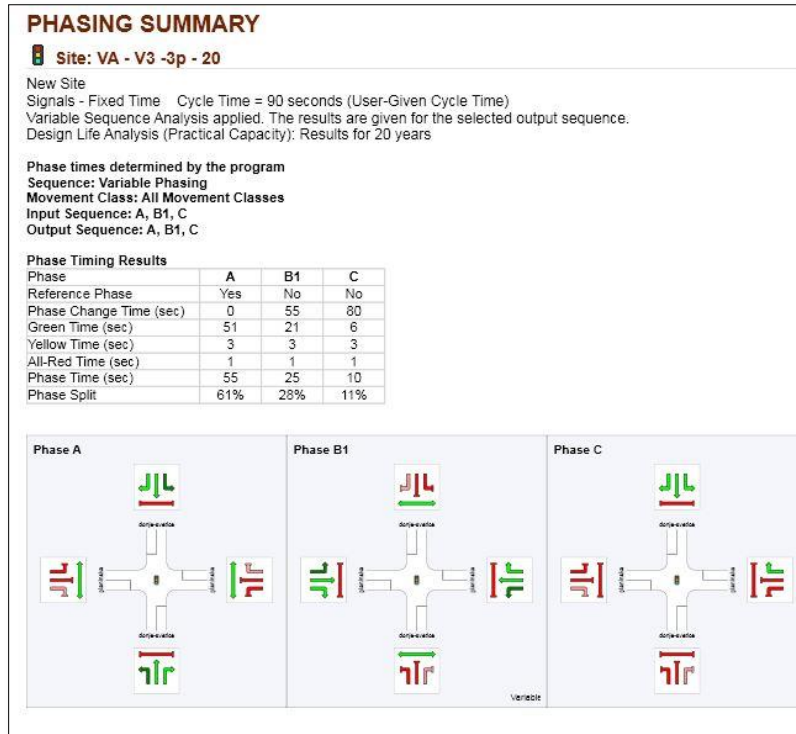

Figure 6-24 Signal phasing of VA_III. for design period of 20 years.

• **Degree of saturation;** approach Planinska Street East has the lowest degree of saturation of 0.73 and approach Planinska Street West with the highest degree of saturation of 1.13 of all approaches. Degree of saturation for intersection is 1.13 which shows intersection demands exceeds the available capacity with excessive delays and queuing. Degree of saturation is shown in Figure 6.25.

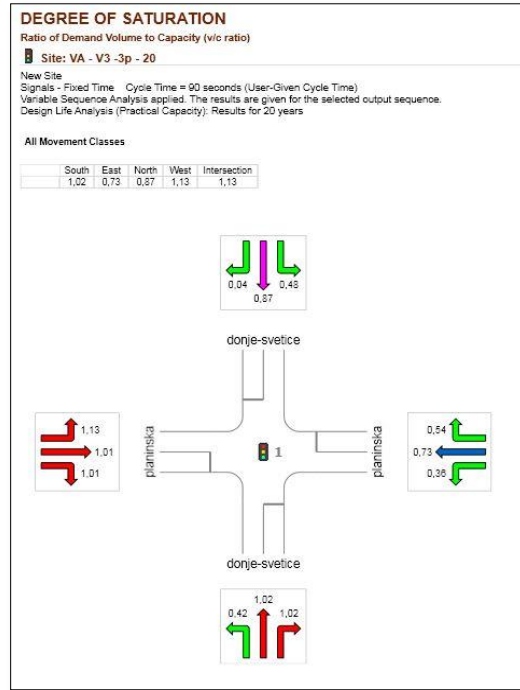

Figure 6-25 Degree of saturation of VA_III for design period of 20 years.

- **Control delay;** approach Planinska Street West has the highest delay is 86.0 s/veh.and approachDonje-Svetice Street North with the lowest delay of 18.5 s/veh. The Delay for the intersection is 39.5 s/veh. *LOS* for intersection is *D*. Delay is shown in Figure 6.26.

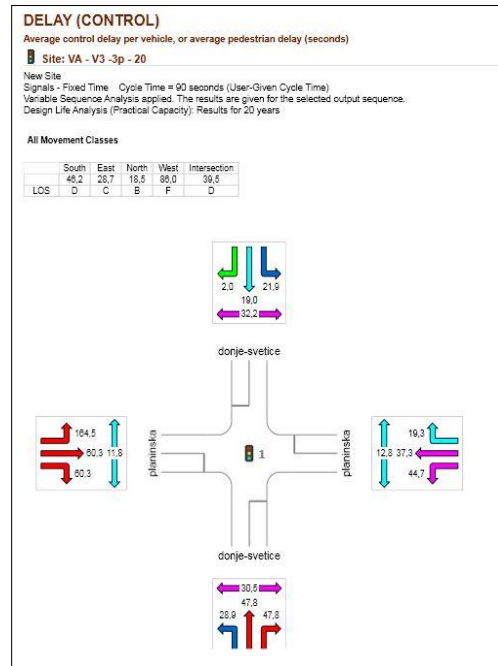

Figure 6-26 Delay of VA_III for design period of 20 years

• **Level of service;** *LOS* of approach Planinska Street West is *F* whereas for approach Donje-Svetice Street North is *B*. Therefore *LOS* of intersection is *D* which states it's approaching unstable conditions of traffic flow. *LOS* is shown in Figure 6.27.

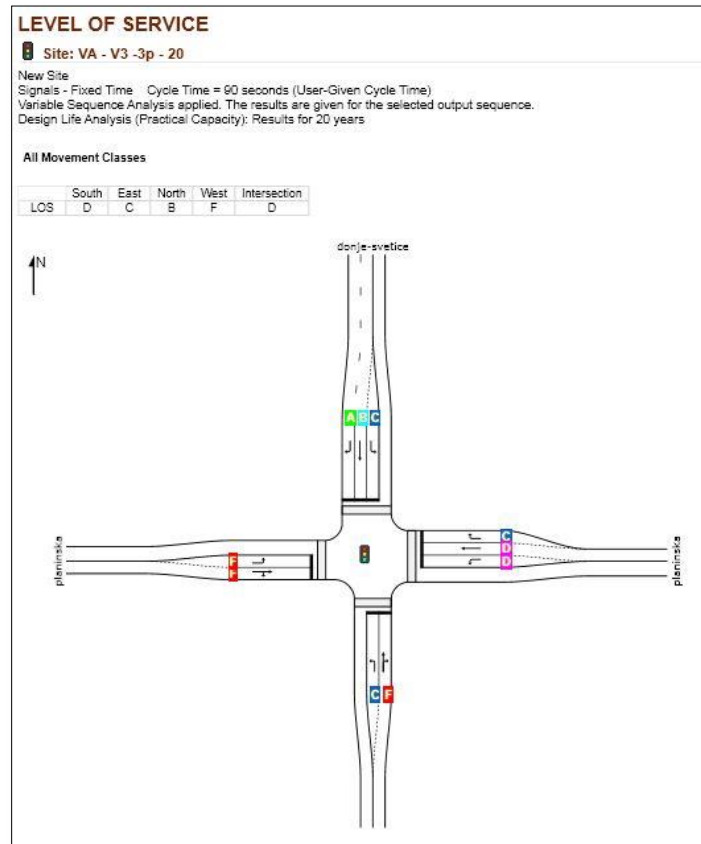

Figure 6-27 Level of service of VA_III for design period of 20 years

Variant VB_I

• **Signal phasing;** intersection B for the design period of 20 years has a three-phase signal plan with a cycle time of 90 seconds. The phase diagram for the intersection is shown below in Figure 6.28. All the movements from south approach occur in phase A and East-West movements occur in Phase B. Green time is 15 and 67 seconds with a uniform clearance time of 3 seconds for phases. Movement timing is shown in Appendix 6.

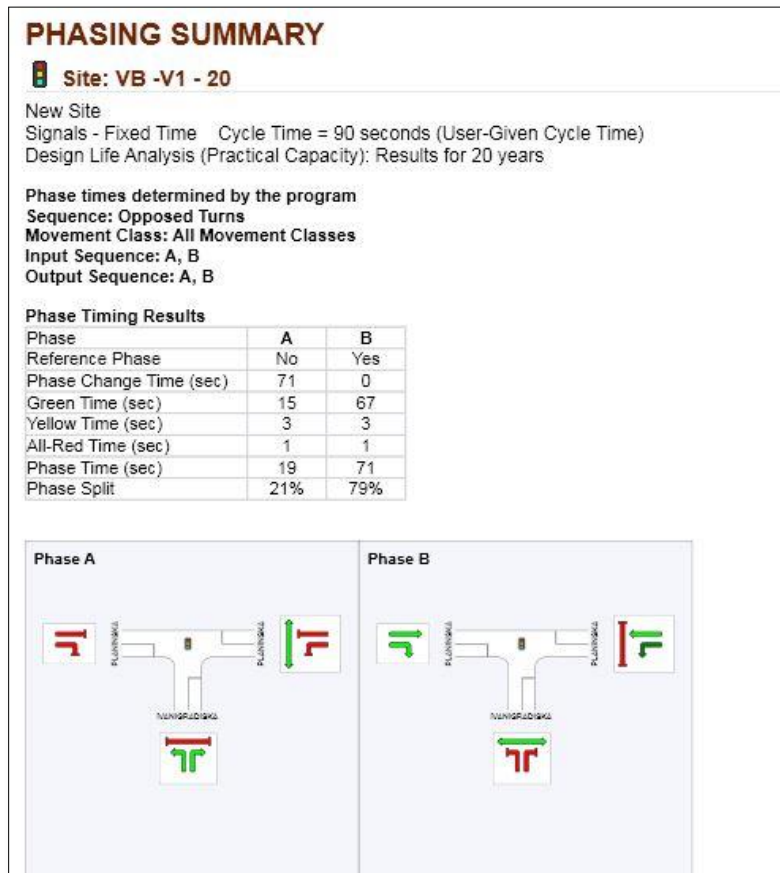

Figure 6-28 Signal phasing of VB_I for design period of 20 years

• **Degree of saturation;** approach Planinska Street has the lowest degree of saturation of 0.39 and approach Square Volovcica Street with the highest degree of saturation of 0.67 of all approaches. Degree of saturation for intersection is 0.67 which shows intersection is operating under capacity without experiencing excessive delays. Degree of saturation is shown in Figure 6.29.

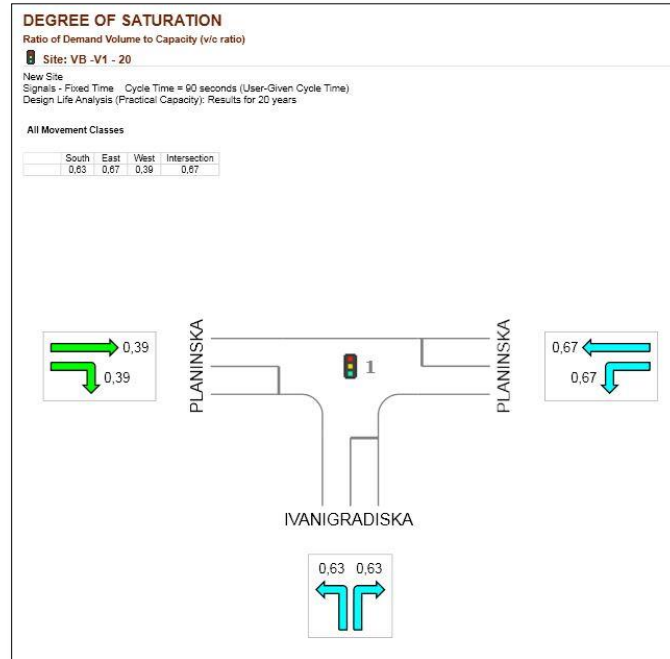

Figure 6-29 Degree of saturation of VB_I for design period of 20 years.

- **Control delay;** approach Ivanigradska Street has the highest delay of 39 s/veh and approach Square Volovcica with the lowest delay of 4.3 s/veh. The delay for intersection is 10.8 s/veh. LOS for intersection is B. Delay is shown in Figure 6.30.

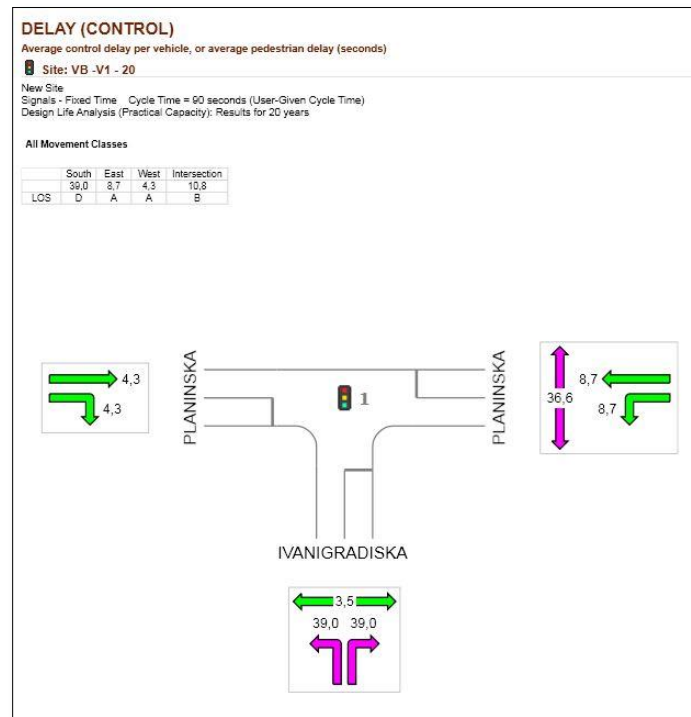

Figure 6-30 Delay of VB_I for design period of 20 years.

• *Level of service*; LOS for approach Planinska and Square Volovcica Street is *D* whereas for approach Ivanicgradska Street has is *C*. Therefore LOS of intersection is *B* which states it's in reasonably in free traffic flow. LOS is shown in Figure 6.31.

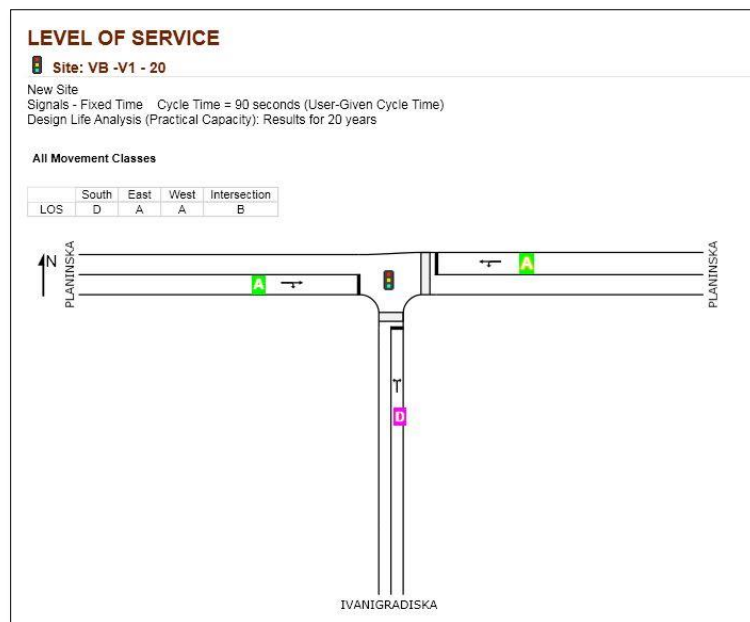

Figure 6-31 Level of service of VB_I for design period of 20 years

6.8 Network analysis

Network analysis is analyzed to know the effect of intersection **B** to intersection **A** on SIDRA. Analysis is done using the traffic data from traffic survey data and input chapter from SIDRA solutions.

The site layout of the existing network of intersection **B** adjacent to intersection **A** is shown below in Figure 6.32 obtained from SIDRA.

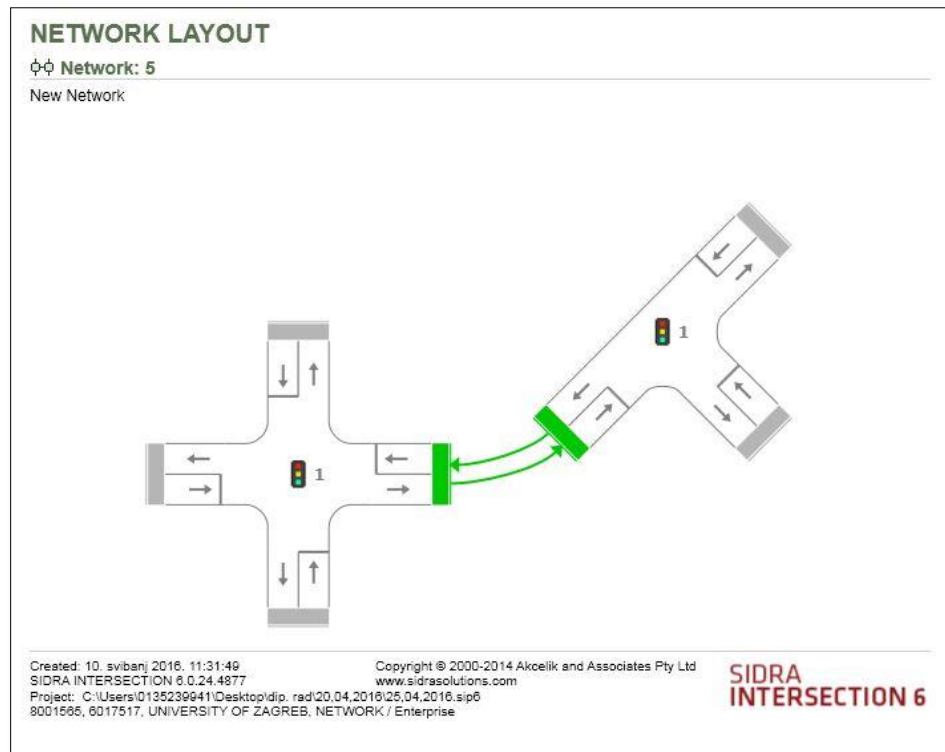

Figure 6-32 Site layout for the existing network of intersection A and B

• **Signal phasing;** the variant VA_III, intersection have three-phase signal plan with cycle time of 90 seconds. The phase diagram for the intersection is shown below in Figure 6.33. All the North-South movements occur in Phase A, East-West movements occur in Phase B and a Phase C with a leading right-turn from East approach and movements from North approach. A green time is 49, 23 and 6 seconds for phases with uniform clearance time of 3 seconds.

The variant VB_I, have two-phase signal plan with cycle time of 90 seconds. The phase diagram for the intersection is shown below in Figure 6.34. All the south movements occur in Phase A and East-West movements occur in Phase B. Green time is 15 and 67 seconds for phases with uniform clearance time of 3 seconds. Movement timing is shown in Appendix 7 and 8.

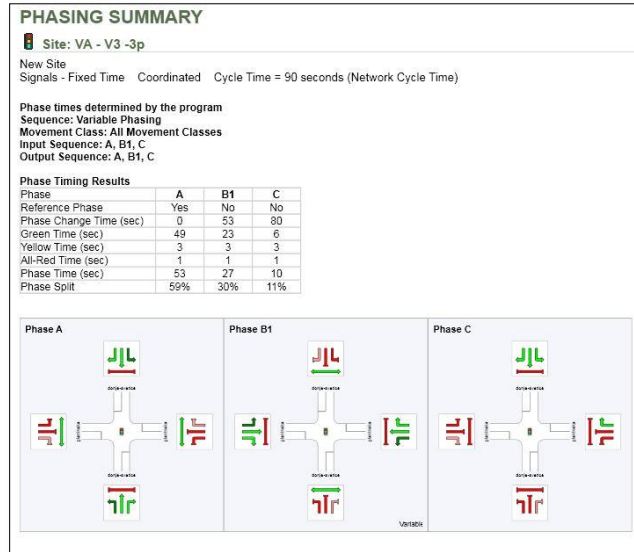

Figure 6-33 Signal phasing of VA_III

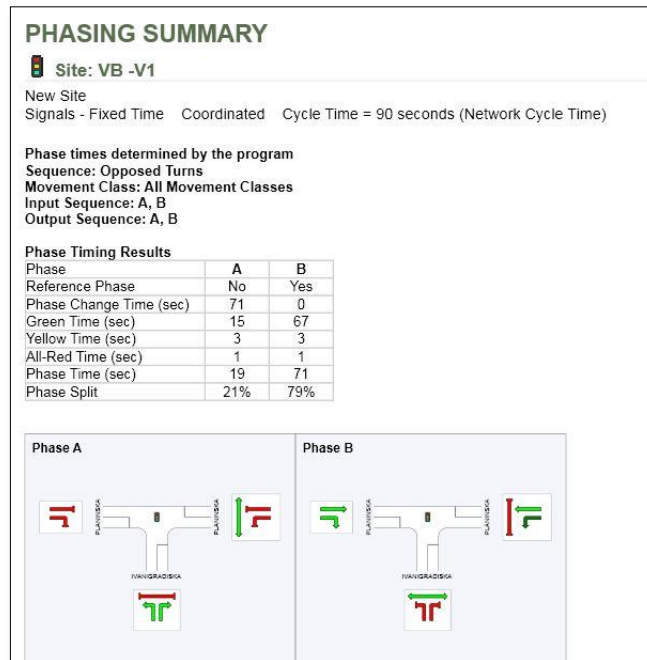

Figure 6-34 Signal phasing of VB_I

• **Degree of saturation;** approach Planinska Street East has the lowest degree of saturation of 0.50 and approach Planinska Street West with the highest 0.69 of all approaches. Degree of saturation for intersection is 0.69 which shows it is operating under capacity without experiencing excessive delays. Degree of saturation is shown in Figure 6.35 for VA_III.

Approach Square Volovcica Street has the lowest degree of saturation of 0.28 and approach Ivanicgradska Street with the highest 0.45 of all approaches. Degree of saturation for intersection is 0.45 which shows intersection is operating under capacity without experiencing excessive delays. Degree of saturation is shown in Figure 6.36 for VB_I.

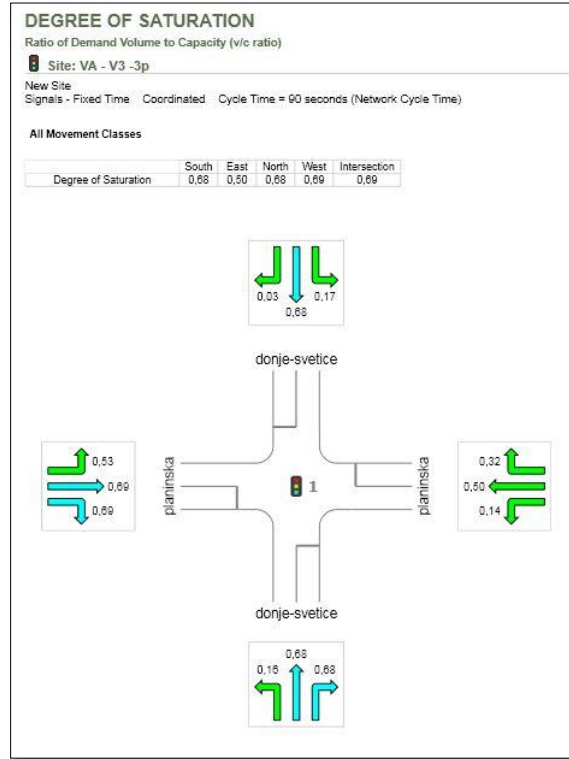

Figure 6-35 Degree of saturation of VA_III.

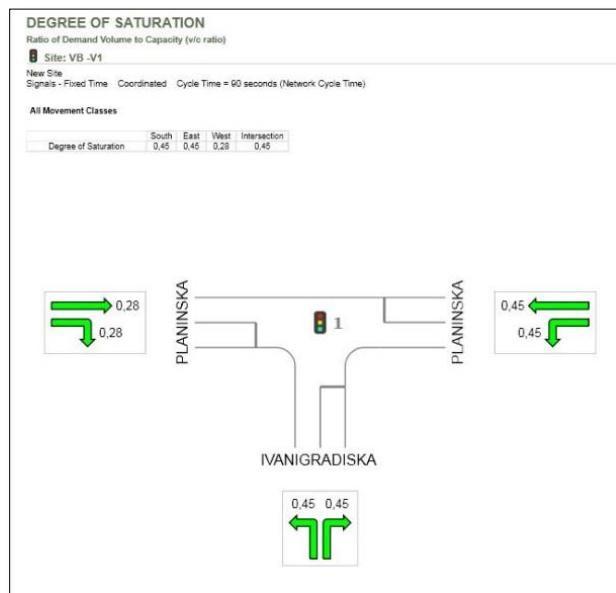

Figure 6-36 Degree of saturation of VB_I.

• **Control delay;** in variant VA_III, approach Planinska Street West has the highest delay of 34.8 s/veh and approach Donje-Svetice Street North with the lowest delay of 10.1 s/veh. The average control delay for the intersection is 17.6 s/veh. *LOS* for intersection is *B*. Delay is shown in Figure 6.37.

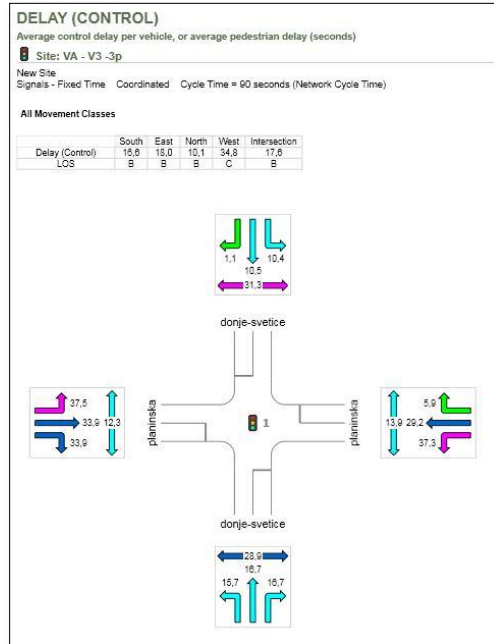

Figure 6-37 Delay of VA_III

In variant VB_I, approach Ivanigradska Street has the highest delay of 34.8 s/veh and approach Square Volovcica Street with the lowest delay of 3.8 s/veh. The delay for the intersection is 8.4 s/veh. *LOS* for intersection is *A*. Delay is shown in Figure 6.38.

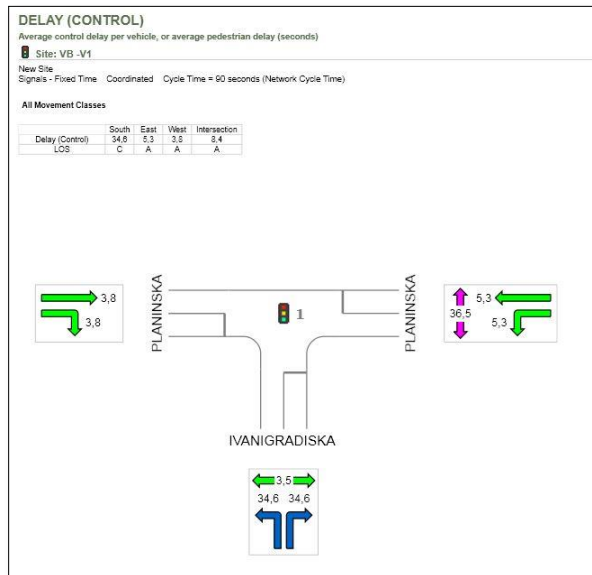

Figure 6-38 Delay of VB_I

• **Level of service; LOS** for approach Planinska Street East and Donje-Svetice Street North and South is *B* whereas for approach Planinska Street West is *C*. Therefore *LOS* of intersection is *B* which state it's reasonably in free traffic flow. *LOS* is shown in Figure 6.39.

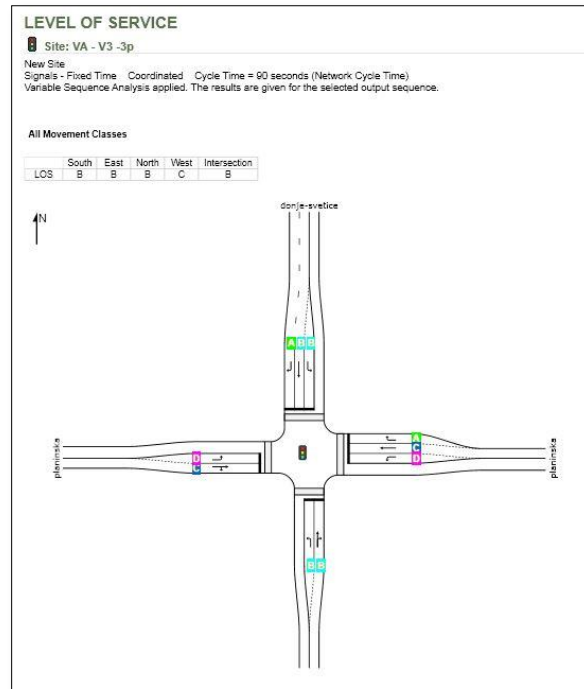

Figure 6-39 Level of service of VA_III

In VB_I., *LOS* for approach Planinska and Square Volovcica Street is *A* whereas for approach Ivanicgradska Street is *C*. Therefore *LOS* of intersection is *A* where its traffic flow is free. *LOS* is shown in Figure 6.40

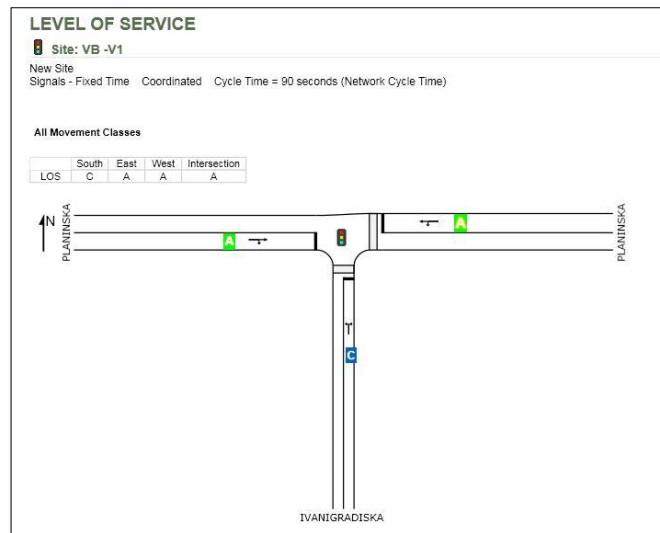

Figure 6-40 Level of service of VB_I

6.9 Network analysis for design period of 20 years

In an analysis network for the design period of 20 years, intersection **A** with three-phase signal plan and intersection **B** with two-phase signal plan is analyzed to know the effect of increasing number of vehicles on *LOS* of the intersections.

• **Signal phasing:** intersection **A** have three-phase signal plan with cycle time of 90 seconds. The phase diagram for the intersection is shown below in Figure 6.41. All the North-South movements occur in Phase A, East-West movements occur in Phase B and a Phase C with a leading right-turn from East approach and movements from North approach. Green time is 49, 23 and 6 seconds for phases with uniform clearance time of 3 seconds. Movement timing is shown in Appendix 8.

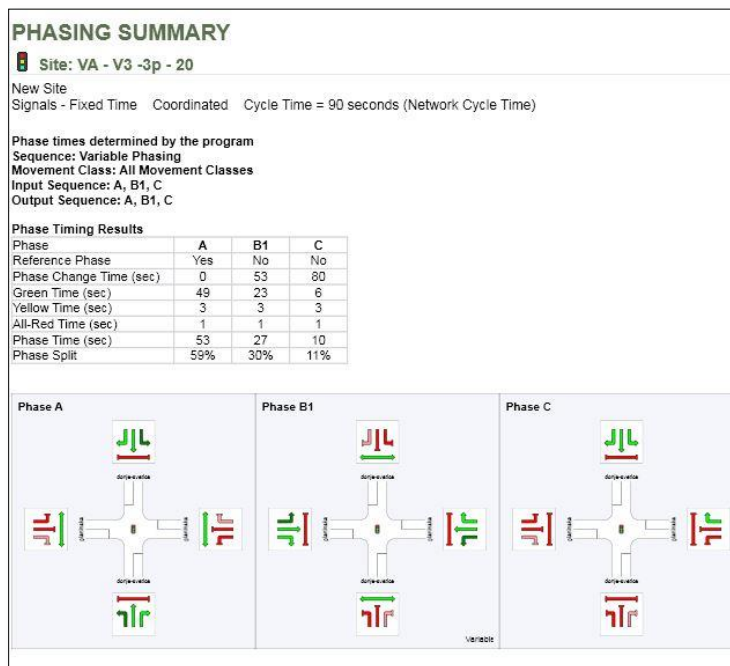

Figure 6-41 Signal phasing of VA_III

Intersection **B** has two-phase signal plan with cycle time of 90 seconds. The phase diagram for the intersection is shown below in Figure 6.42. All the South movements occur in Phase A and East-West movements occur in Phase B. Green time is 15 and 67 seconds for phases with uniform clearance time of 3 seconds. Movement timing is shown in Appendix 9.

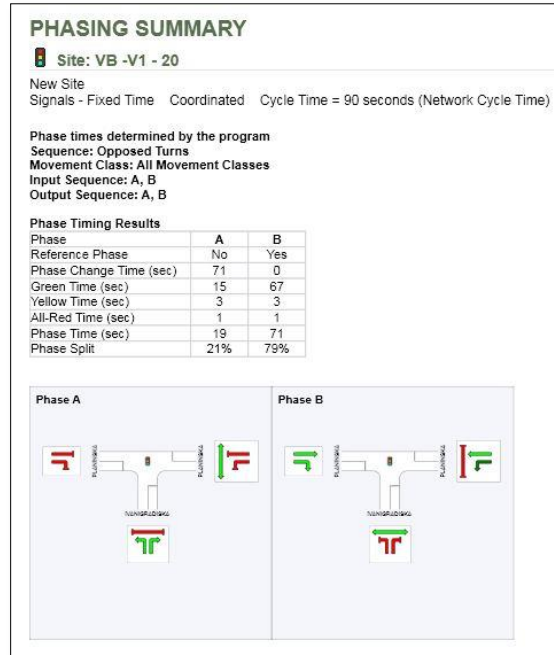

Figure 6-42 Signal phasing of VB_I

• **Degree of saturation;** approach Planinska Street East has the lowest degree of saturation of 0.50 and approach Planinska Street West with the highest degree of saturation of 0.69 of all approaches. Degree of saturation of intersection is 0.69 which shows intersection is operating under capacity without experiencing excessive delays. Degree of saturation for VA_III is shown in Figure 6.43.

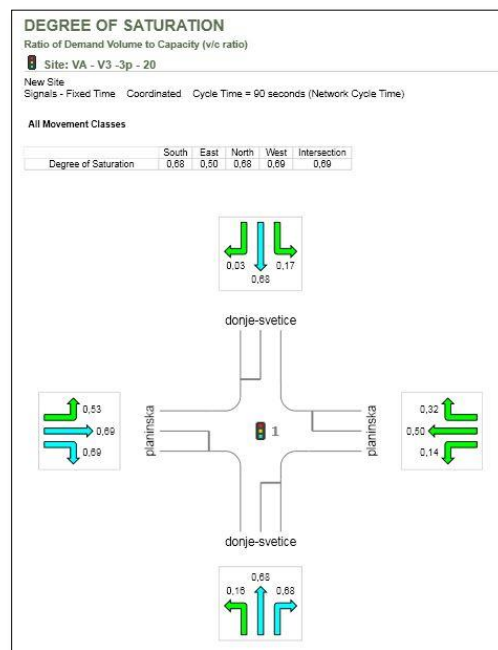

Figure 6-43 Degree of saturation of VA_III

In VB_I, approach Planinska Street has the lowest degree of saturation of 0.28 and approach Square Volovcica Street with 0.69. Degree of saturation for intersection is 0.45 which is operating under capacity without experiencing excessive delays. Degree of saturation for VB_I is shown in Figure 6.44.

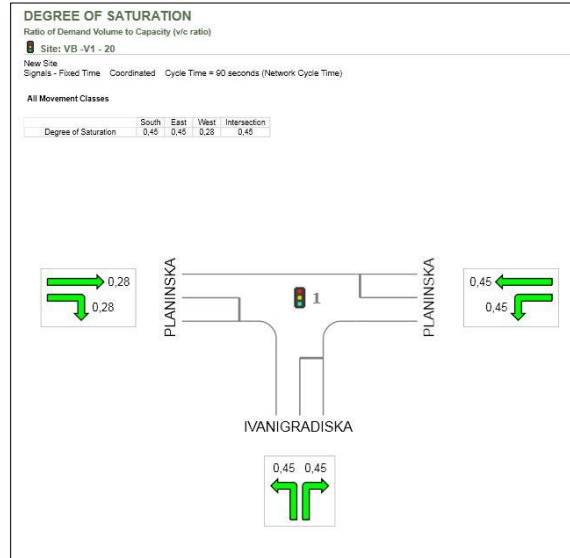

Figure 6-44 Degree of saturation of VB_I

• **Control delay;** approach Planinska Street West has the highest delay of 34.8 s/veh. and approach Donje-Svetice Street North with the lowest delay of 10.1 s/veh. Delay for the intersection is 17.6 s/veh. LOS for intersection is B where the flow of traffic is reasonably free. Delay for VA_III is shown in Figure 6.45.

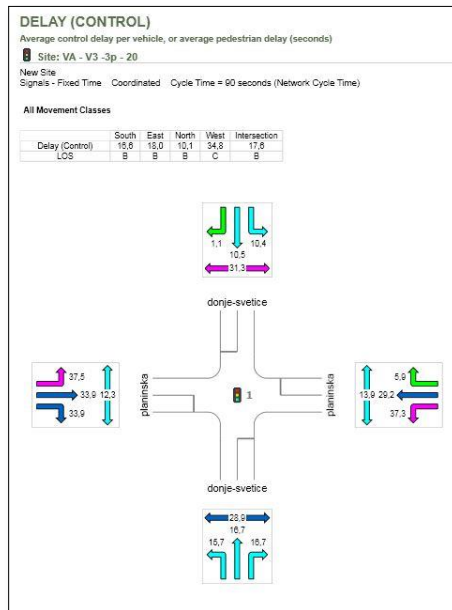

Figure 6-45 Delay for VA_III

In variant VB_I, approach Ivanigradska Street has the highest delay of 34.8 s/veh and approach Square Volovcica Street with the lowest delay of 3.8 s/veh. Delay for the intersection is 8.4 s/veh. *LOS* for intersection is *A* where the flow of traffic is free. Delay for VB_I is shown in Figure 6.46.

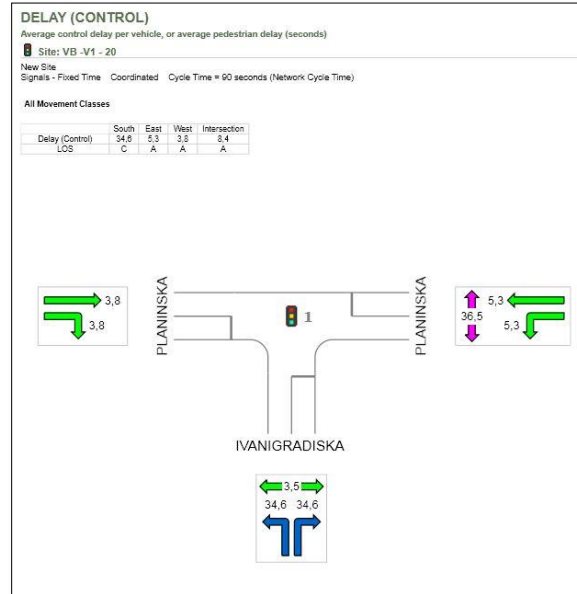

Figure 6-46 Delay for variant VB_I

• *Level of service*; *LOS* for approach Planinska Street East and Donje-Svetice Street North and South is *B* whereas for approach Planinska Street West is *C*. Therefore *LOS* of intersection is *B* which states it's reasonably in free traffic flow. *LOS* for VA_III is shown in Figure 6.47.

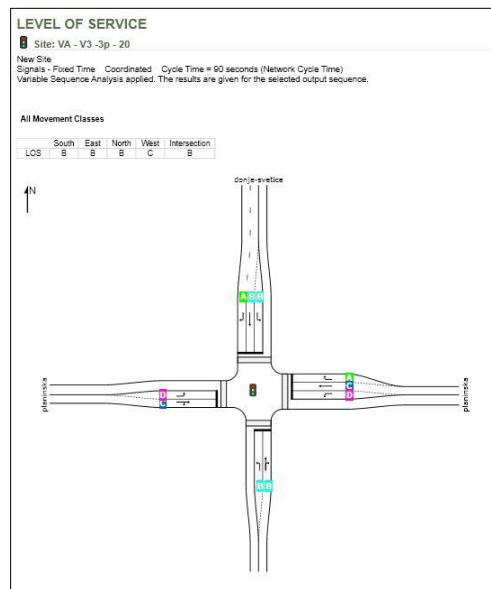

Figure 6-47 Level of service of VA_III

In VB_I, *LOS* of approach Planinska and Square Volovcica Street is *A* whereas for approach Ivanicgradska Street is *C*. Therefore the *LOS* for intersection is *A* where traffic flow is in free flow. *LOS* for VB_I is shown in Figure 6.48.

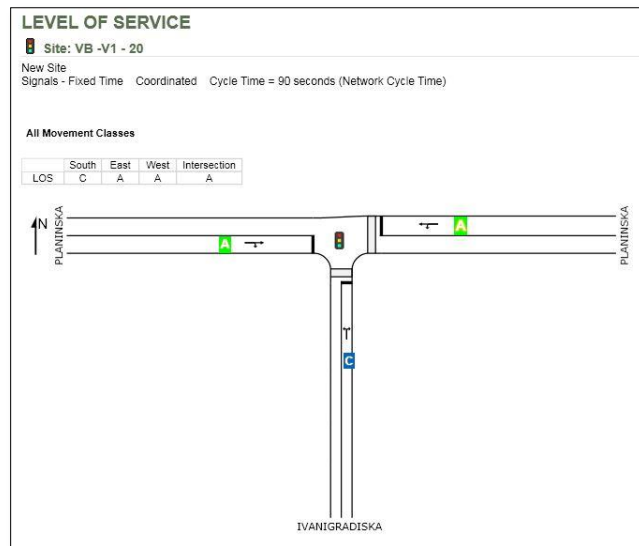

Figure 6-48 Level of service of variant VB_I

6.10 Results summary

• Summary of results

The analyses of design variants for intersection **A** and **B** is shown below in Table 6.1.

Table 6-1 Result from SIDRA for design variants for intersection A and B

Results from SIDRA			
Variants	Approach	Delay (s/veh)-LOS	
		Approach	Intersection
VA_O.	1	B (19.8)	C (21.5)
	2	B (15.8)	
	3	C (27.3)	
	4	C (27.9)	
VA_I.	1	B (11.8)	D (36.1)
	2	D (47.6)	
	3	D (39.7)	
	4	E (62.1)	
VA_II.	1	B (12.1)	B (18.5)
	2	B (15.5)	
	3	C (28.7)	
	4	C (32.7)	
VA_III.	1	B (10.1)	B (17.9)
	2	B (16.6)	
	3	B (18.0)	
	4	C (34.8)	
VB_O.	1	C (24.8)	A (4.7)
	2	A (3.2)	
	3	A (0.0)	
VB_I.	1	C (34.6)	A (8.4)
	2	A (5.3)	
	3	A (3.8)	

The analysis of intersection **A** from SIDRA proves that re-route of right hand turn traffic from approach Planinska Street East through the Vugrovecka Street to approach Donje-Svetice South Street and addition of traffic lane on approach Planinska Street East and approach Donje-Svetice Street North with three phase signal plan shows promising results than other variants.

The analysis of intersection **B** from SIDRA shows that the variants VB_O and VB_I show the same LOS (A). TWSC result is better than two phase signal plan at existing flow of traffic.

Analysis of the variants for intersection A is shown below in Figure 6.49.

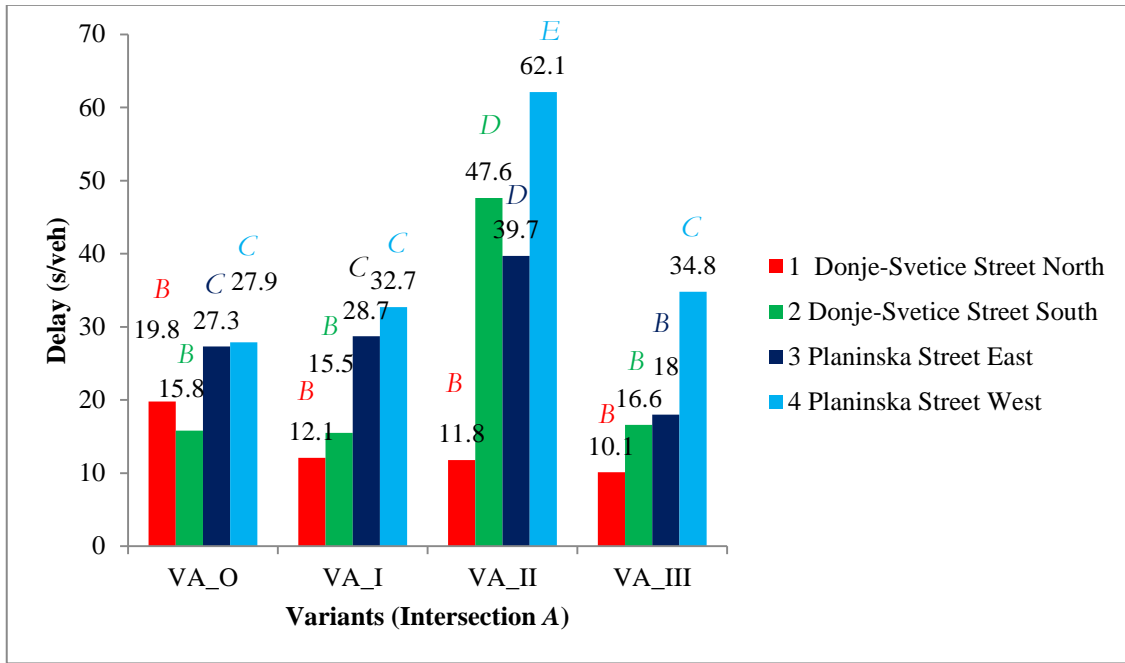

Figure 6-49 Results of the variants for intersection A

Analysis of the variants for intersection B is shown below in Figure 6.50.

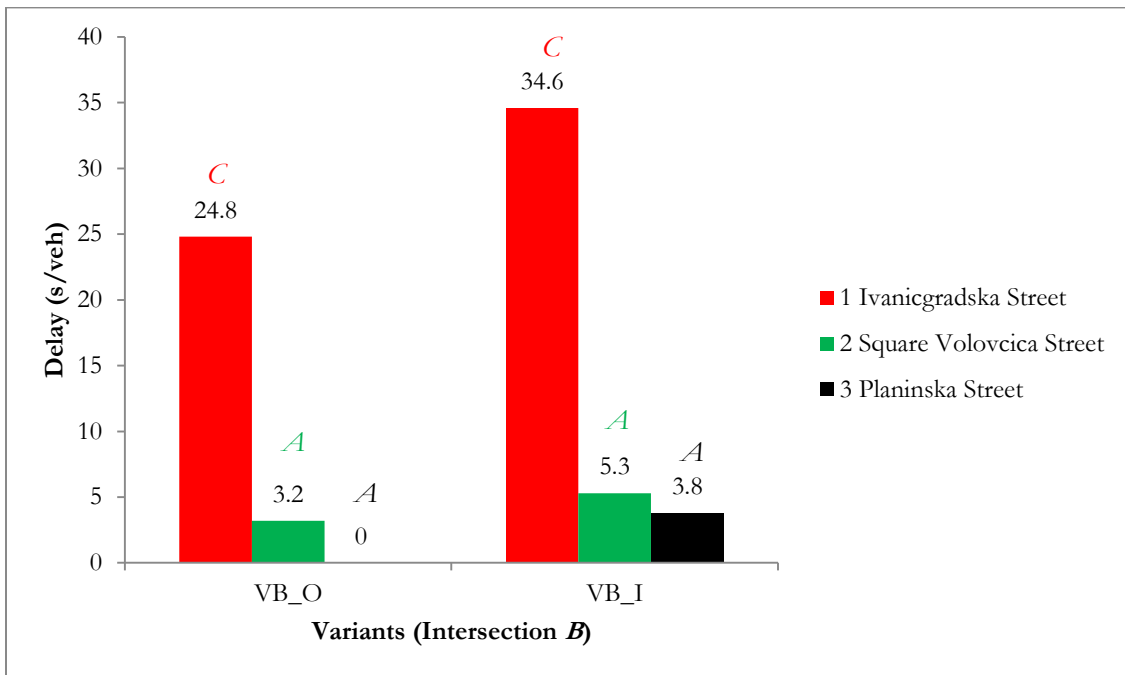

Figure 6-50 Results for the variants of intersection B

Sensitivity analysis and network analysis of design variants for intersection **A** and **B** are shown below in Table 6.2.

Table 6-2 Results of sensitivity and network analysis for intersection A and B

Results from SIDRA				
Traffic volume	Variants	Approach	Delay (s/veh)-LOS	
			Approach	Intersection
Existing	VA_III.	1	B (10.10)	B (17.60)
		2	B (16.60)	
		3	B (18.00)	
		4	C (34.80)	
	VB_I.	1	C (24.80)	A (4.70)
		2	A (3.20)	
3		A (0.00)		
Design period (20 years)	VA_III.	1	B (17.00)	D (43.90)
		2	D (50.90)	
		3	C (30.50)	
		4	F (106.30)	
	VB_I.	1	D (39.00)	B (10.80)
		2	A (8.70)	
3		A (4.30)		
Network analysis of intersection A and B				
Existing	VA_III.	1	B (10.10)	B (17.60)
		2	B (16.60)	
		3	B (18.00)	
		4	C (34.80)	
	VB_I.	1	C (34.6)	A (8.40)
		2	A (5.3)	
3		A (3.8)		
Design period (20 years)	VA_III.	1	B (10.10)	B (17.60)
		2	B (16.60)	
		3	B (18.00)	
		4	C (34.80)	
	VB_I.	1	C (34.6)	A (8.40)
		2	A (5.3)	
3		A (3.8)		

In a network analysis of the intersection **A** and **B** of variant VA_III and VB_I, Level of Service for variant VA_III is *B* and *A* for the variant VB_I.

In a network analysis of the variant VA_III and VB_I for the designed period of 20 years, Level of Service for variant VA_III is *B* and *A* for the variant VB_I. The design period of 20 years doesn't have any effect on the *LOS* of the intersection.

Sensitivity analysis of variants from intersection **A** and **B** is shown below in Figure 6.51.

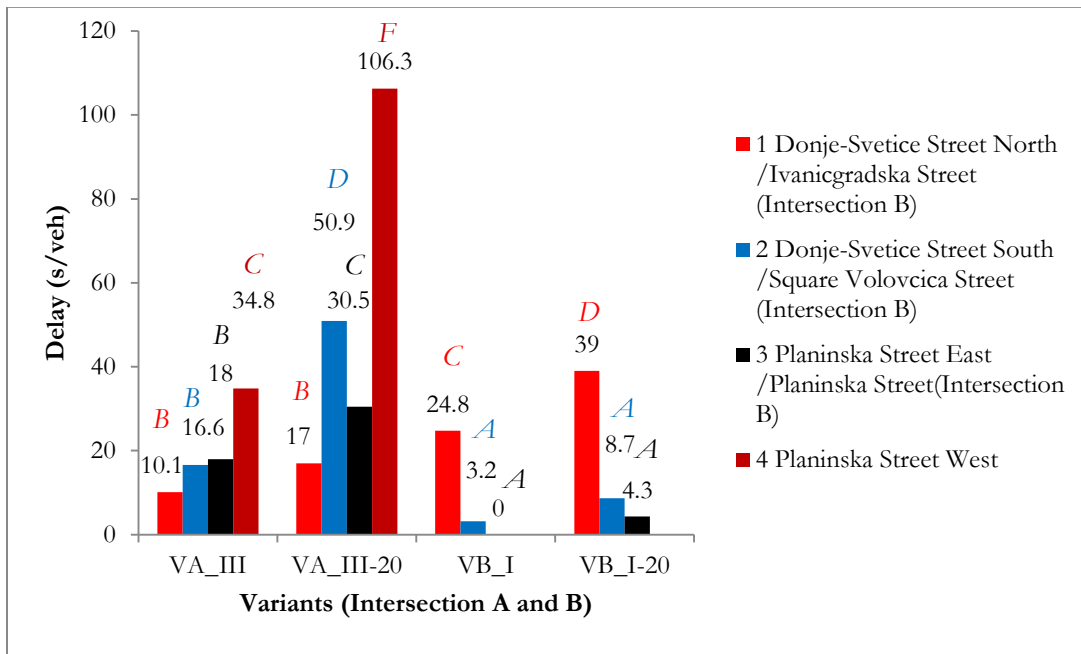

Figure 6-51 Results of sensitivity analysis for VA_III and VB_I

Network analysis of variants from intersection **A** and **B** is shown below in Figure 6.52.

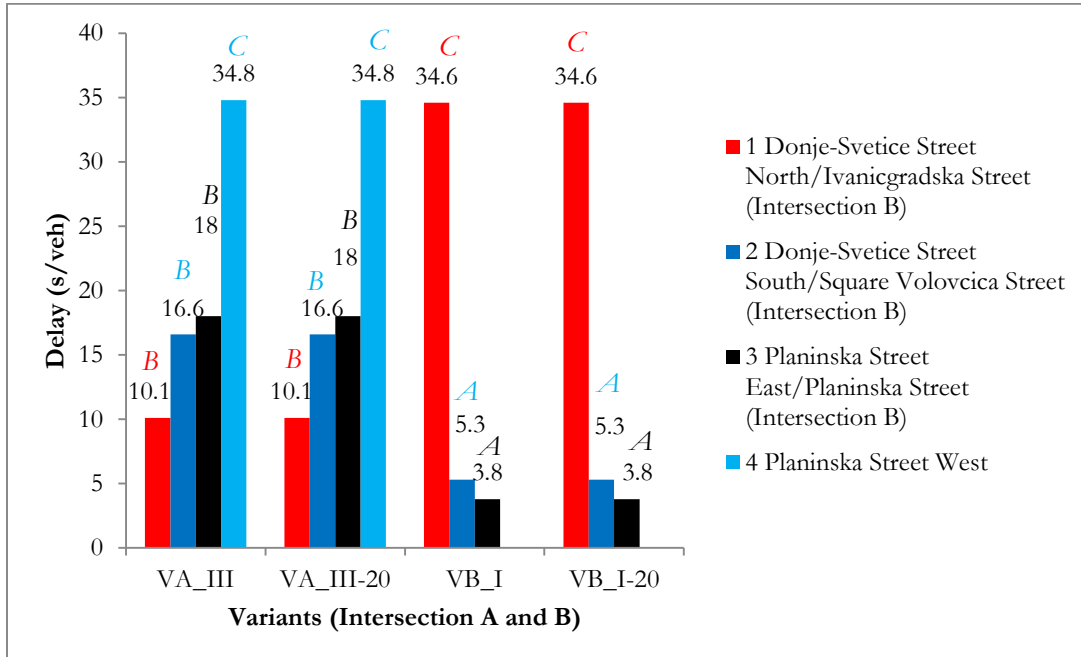

Figure 6-52 Results of network analysis for variant VA_III and VB_I

7 CONCLUSION

The main goal of the master thesis is functional efficiency optimization of Donje-Svetice and Planinska Street intersection to ease the traffic congestion and queuing of vehicles on the Planinska Street East. The intersection is located in the City of Zagreb which connects the main street of the Zagreb, Kneza Branimira and Grada Vukovara Street.

Traffic volume study shows that the approach Donje-Svetice Street South and North have highest PCU (Chapter 4) of 758.5 and 671.5 veh/h. Approach Donje-Svetice Street North have highest AADT (Chapter 4) of 7585 veh/h for 2016. Proposed design variants for optimization of intersection **A** (Donje Svetice and Planinska Street) are:

- three-phase signal plan (VA_I.);
- re-route of right-turn traffic of Planinska Street East (VA_II.); and
- addition of lane on Planinska Street East and Donje-Svetice Street North (VA_III.).

Proposed optimization design variant for intersection **B** (Planinska, Square Volovcica and Ivanicgradska Street) is introducing traffic signals.

From the results of SIDRA for intersection **A**, it is concluded for VA_0 that approach Donje-Svetice Street North has the lowest delay of 15.8 s/veh (*LOS B*) and approach Planinska Street West with the highest delay of 27.9s/veh (*LOS C*). *LOS* for intersection is *C* (21.5 s/veh).

For VA_I., it is found that approach Donje-Svetice Street North has the lowest delay of 11.8 s/veh (*LOS B*) and approach Planinska Street West with the highest delay of 62.1 s/veh (*LOS E*). *LOS* for intersection is *D* (36.1 s/veh). For VA_II., it is found that approach Donje-Svetice Street North has the lowest delay of 12.1 s/veh (*LOS B*) and approach Planinska Street West with the highest delay of 32.7 s/veh (*LOS C*). *LOS* for intersection is *B* (18.5 s/veh). For VA_III., it's found that approach Donje-Svetice Street North has the lowest delay of 10.1 s/veh (*LOS B*) and approach Planinska Street West with the highest delay of 34.8 s/veh (*LOS C*). *LOS* for intersection is *B* (17.9 s/veh).

From the results of SIDRA for intersection **B**, it is found that for the existing design that approach Planinska Street has the lowest delay of 0 s /veh (*LOS A*) and approach Ivanicgradska with the highest delay of 24.8 s/veh (*LOS C*). *LOS* for intersection is *A* (4.7 s/veh). For VB_I, it is found that approach Planinska Street has the lowest delay of 3.8 s/veh (*LOS A*) and approach Ivanicgradska Street with the highest delay of 34.6 s/veh (*LOS C*). *LOS* for intersection is *A* (8.4 s/veh).

Sensitivity analysis of VA_III for a period of 20 years shows that the approach Donje-Svetice Street North has the lowest delay of 17.00 s/veh (*LOS B*) and approach Planinska Street West with the highest delay of 106.30 s/veh (*LOS F*). *LOS* for intersection is *D* (43.90 s/veh). For VB_I, approach Planinska Street has the lowest delay of 3.8 s/veh (*LOS A*) and approach Ivanicgradska Street with the highest delay of 39.00 s/veh (*LOS C*). *LOS* for intersection is *B* (10.80 s/veh).

In network analysis, VA_III and VB_I is analyzed with existing traffic in which its result shows that *LOS* of VA_III is *A* (8.40 s/veh) and VB_I is *B* (17.60 s/veh). Variant VA_III and VB_I is analyzed for the design period of 20 years in which its result shows that *LOS* of VA_III is *B* (17.60 s/veh) and VB_I is *A* (8.40 s/veh) respectively.

Re-route of the right-hand traffic of Planinska Street East and additions of lane on Planinska Street East and approach Donje-Svetice Street North gives the lowest delay values and improved level of service for the intersection **A** as per SIDRA analysis results. Intersection **B** doesn't have any effects on the intersection **A** in network analysis for design period of 20 years.

Therefore, the variant VA_III and VB_I is most appropriate solution for eliminating the traffic congestion on the approach Planinska Street East and improving the *LOS* of the intersection **A** and **B**.

8 Bibliography

- [1.] A.Saltelli. (2008). *Global Sensitivity Analysis: The Primer*. Chichester: John Wiley & Sons Ltd.
- [2.] Akmaz, M. M., & Celik, O. N. (2016). Examination of Signalized Intersections According to Australian and HCM Methods Using Sidra Intersection Software. *Journal of Civil Engineering and Architecture*, 246-259.
- [3.] Ali, H., Hooman, & Rabu, Z. B. (n.d.). Optimization of Traffic Flow by using Sidra Intersection.
- [4.] Ayehu, F. M. (2015). *Evaluation of Traffic Congestion and Level of Service at Major Intersection in Adama City*. Addis Ababa.
- [5.] Council, N. R. (2010). *Highway Capacity Manual*. Washington DC, USA: Transportation Research Board.
- [6.] Das, A., Barua, S., & Roy, K. C. (2015). A Study on Feasible Operation Alternatives at Signalized Intersection in Dhaka City. *Civil Engineering for Sustainable Development*. Gazipur, Bangladesh: Researchgate.
- [7.] Google. (n.d.). *Google*. Retrieved from Google maps: <https://www.google.hr/maps>
- [8.] Halder, S., Islam, M. A., & Alam, M. R. (2013). *Traffic Volume Study*. Researchgate.
- [9.] Haregewoin. (2010). *Impact of Vehicle Traffic Congestion in Addis Ababa*. Addis Ababa: Ethiopian Civil Service College.
- [10.] Inc, T. S. (n.d.). *Transoft Solution*. Retrieved May 28, 2016, from Transoft Solutions Inc.: <http://www.transoftsolutions2015.com/autoturn>
- [11.] KumarV, S., & J.Ranjitha. (2013). Improvement of Traffic Operations in Congested Signalized Intersections - A Case Study in Bangalore City. *International Journal of Engineering Research & Technology*, 2284-2291.
- [12.] Legac, P. I. (2008). *Raskrizija Javnih Cesta, Cestovne Prometnice II*. Zagreb.
- [13.] Ltd, A. &. (2016). *Sidra Solution*. Retrieved from <http://www.sidrasolutions.com/Resources/HCM2010>

- [14.] Mathew, T. (2012, June 25). *National Programme on Technology Enhanced Learning*. Retrieved from National Programme on Technology Enhanced Learning: <http://nptel.ac.in/courses/105101008/34>
- [15.] Mathew, T. V. (2014, August 5). *Traffic Engineering And Management*. Retrieved from www.civil.iitb.ac.in: https://www.civil.iitb.ac.in/tvm/1111_nptel/564_UnCotrl/plain/plain.html
- [16.] Pilko, H. (2014). *Optimization of Roundabout Design and Safety Components*, doctoral thesis, University of Zagreb, Faculty of Transport and Traffic Sciences, Zagreb.
- [17.] Transport Solutions Inc. (2015, May). Auto TURN. Calgary, Canada.
- [18.] Yumlu, C., Sara, M., & Akcelik, R. (2014). Measuring and Assessing Traffic Congestion : A case study. *AITPM 2014 National Conference*. Adelaide: Sidra Solutions.

List of Figures

Figure 2-1 a) Classical intersection b) Classical intersection with conflict points	8
Figure 2-2 One type of the grade separated intersection, Source:[12].....	9
Figure 2-3 Examples of combined intersection, Source:[12].....	9
Figure 4-1 Aerial view of site layout, Source: [7]	18
Figure 4.2 Intersection view: a) Donje-Svetice Street North, b) Donje-Svetice Street South.....	19
Figure 4.3 Intersection view: a) Planinska Street West, b) Planinska Street East.....	19
Figure 4-4 Intersection view: a) Square Volovcica Street; b) Planinska Street.....	20
Figure 4-5 Ivanicgradska Street	20
Figure 4-6 Proposed study areas on Donje-Svetice and Planinska Street, Source: [7].....	23
Figure 4-7. Volume of traffic in PCU for intersection A.....	24
Figure 4-8. Traffic flow pattern in PCU for intersection A	24
Figure 4-9. Volume of traffic in PCU for intersection B	24
Figure 4-8. Traffic flow pattern in PCU for intersection B	25
Figure 5-1 Vehicle used in auto TURN, Source:[15]	28
Figure 6-1 Signal phasing of VA_O	29
Figure 6-2 Degree of saturation of VA_O.	30
Figure 6-3 Delay of VA_O	30
Figure 6-5 Signal phasing of VA_I.....	32
Figure 6-6 Degree of saturation of VA-I	32
Figure 6-7 Delay of VA_I.	33
Figure 6-8 Level of service for the variant VA_I.....	33
Figure 6-9 Signal phasing for VA_II.	34
Figure 6-10 Degree of saturation for VA_II.	35
Figure 6-11 Delay for VA_II.	35
Figure 6-12 Level of service for VA_II.	36
Figure 6-13 Signal phasing for VA_III.....	37
Figure 6-14 Degree of saturation for VA_III.....	38

Figure 6-15 Delay for VA-III.....	38
Figure 6-16 Level of service for VA_III.....	39
Figure 6-17 Degree of saturation for VB_O.	40
Figure 6-18 Delay for VB_O.	41
Figure 6-19 Level of service for VB_O.....	41
Figure 6-20 Signal phasing for VB_I.....	42
Figure 6-21 Degree of saturation for VB_I.....	43
Figure 6-22 Delay for VB_I.....	43
Figure 6-23 Level of service for VB_I.....	44
Figure 6-24 Signal phasing of VA_III. for design period of 20 years.	45
Figure 6-25 Degree of saturation of VA_III. for design period of 20 years.	45
Figure 6-26 Delay of VA_III. for design period of 20 years.	45
Figure 6-27 Level of service of VA_III for design period of 20 years	47
Figure 6-28 Signal phasing of VB_I for design period of 20 years	48
Figure 6-29 Degree of saturation of VB_I for design period of 20 years.....	49
Figure 6-30 Delay of VB_I for design period of 20 years.	49
Figure 6-31 Level of service of VB_I for design period of 20 years.....	50
Figure 6-32 Site layout for the existing network of intersection A and B	51
Figure 6-33 Signal phasing of VA_III	52
Figure 6-34 Signal phasing of VB_I.....	52
Figure 6-35 Degree of saturation of VA_III.	53
Figure 6-36 Degree of saturation of VB_I.....	53
Figure 6-37 Delay of VA_III	54
Figure 6-38 Delay of VB_I.....	54
Figure 6-39 Level of service of VA_III	55
Figure 6-40 Level of service of VB_I.....	55
Figure 6-41 Signal phasing of VA_III.....	56
Figure 6-42 Signal phasing of VB_I.....	57
Figure 6-43 Degree of saturation of VA_III	57

Figure 6-44 Degree of saturation of VB_I.....	58
Figure 6-45 Delay for VA_III.....	58
Figure 6-46 Delay of variant VB_I.....	59
Figure 6-47 Level of service of VA_III.....	59
Figure 6-48 Level of service of variant VB_I.....	60
Figure 6-49 Results of the variants for intersection A.....	62
Figure 6-50 Results for the variants of intersection B.....	62
Figure 6-51 Results of sensitivity analysis for VA_III and VB_I.....	64
Figure 6-52 Results of network analysis for variant VA_III and VB_I.....	64

List of Tables

Table 3-1 Criteria that HCM2010 adapts for assessing the LOS, Source:[5]	13
Table 3-2 Criteria that HCM adapts in assessing the level of service (LOS), Source:[5]	17
Table 6-1 Result from SIDRA for design variants for intersection A and B	61
Table 6-2 Results of sensitivity and network analysis for intersection A and B	63

Appendix

Appendix 1. Movement timing for VA_O.

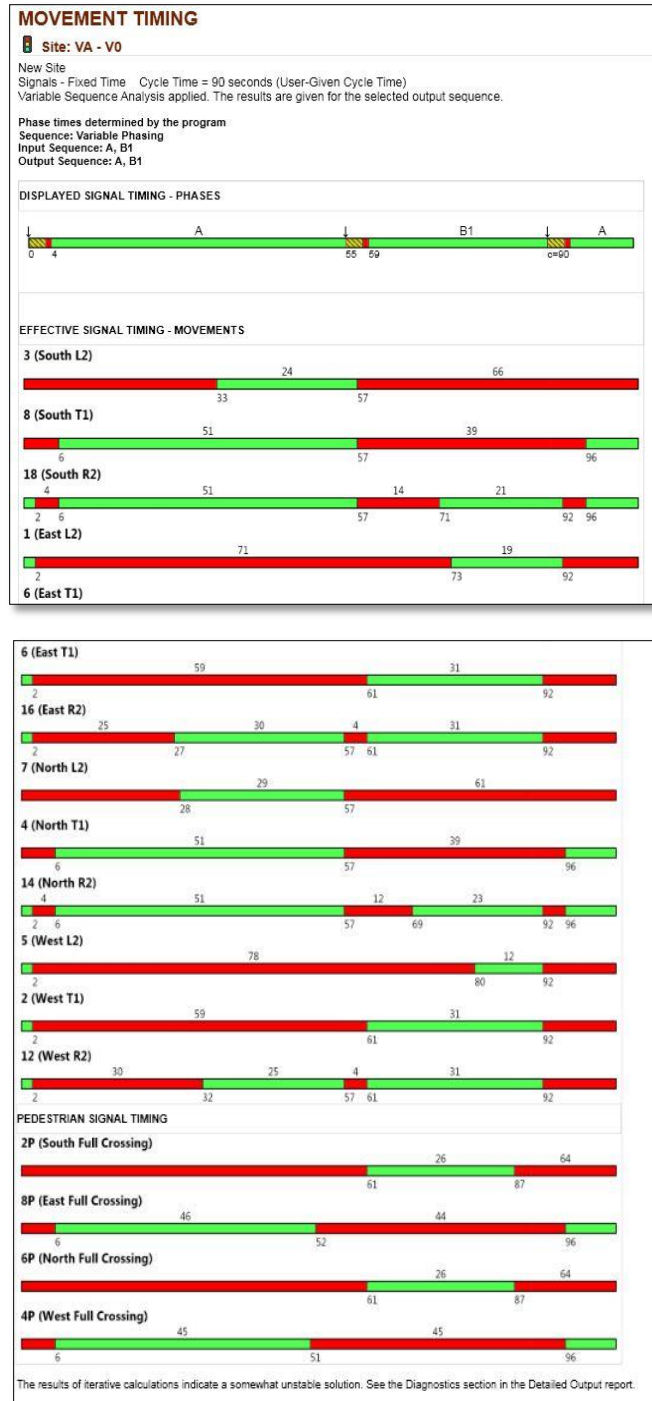

Appendix 2. Movement timing for VA_I.



Appendix 3. Movement timing for VA_II.



Appendix 4. Movement timing for VA_III.

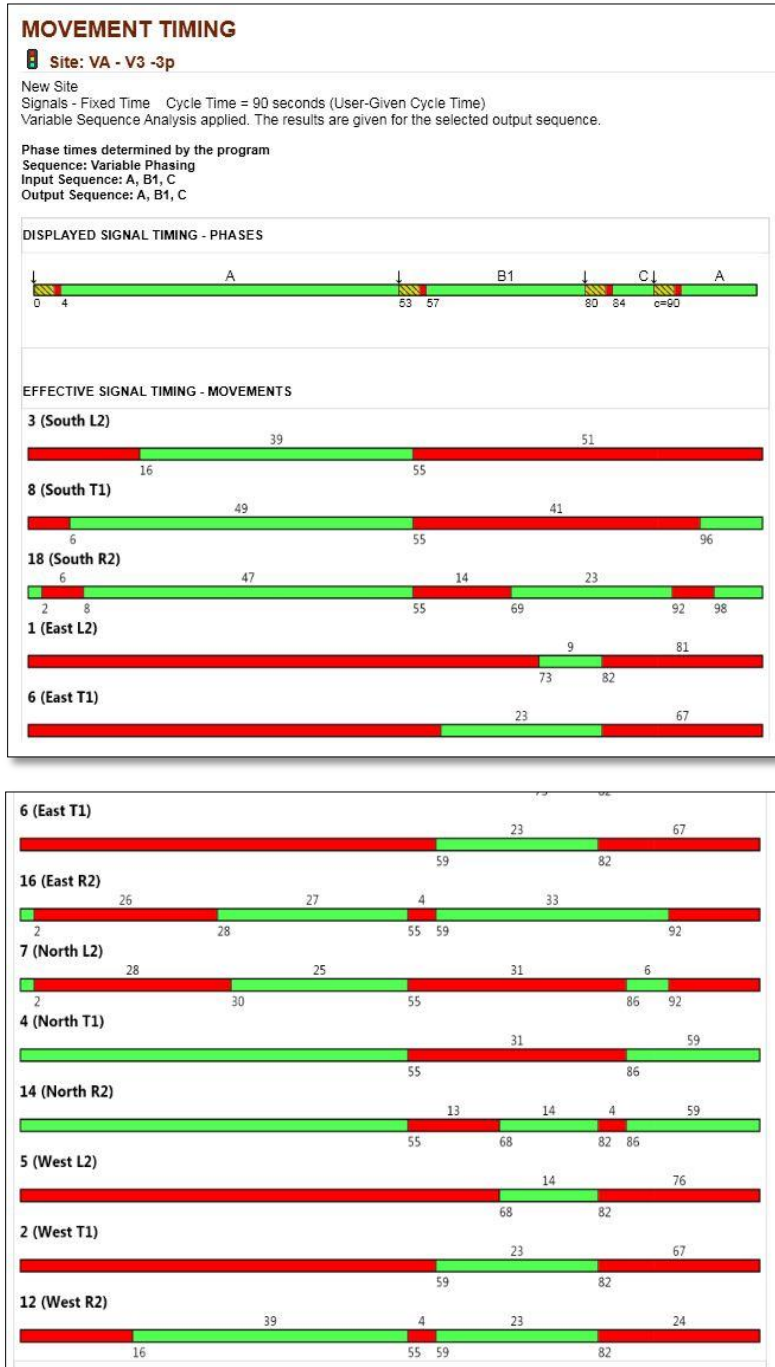

Appendix 5. Movement timing for VA_III-3P-20.

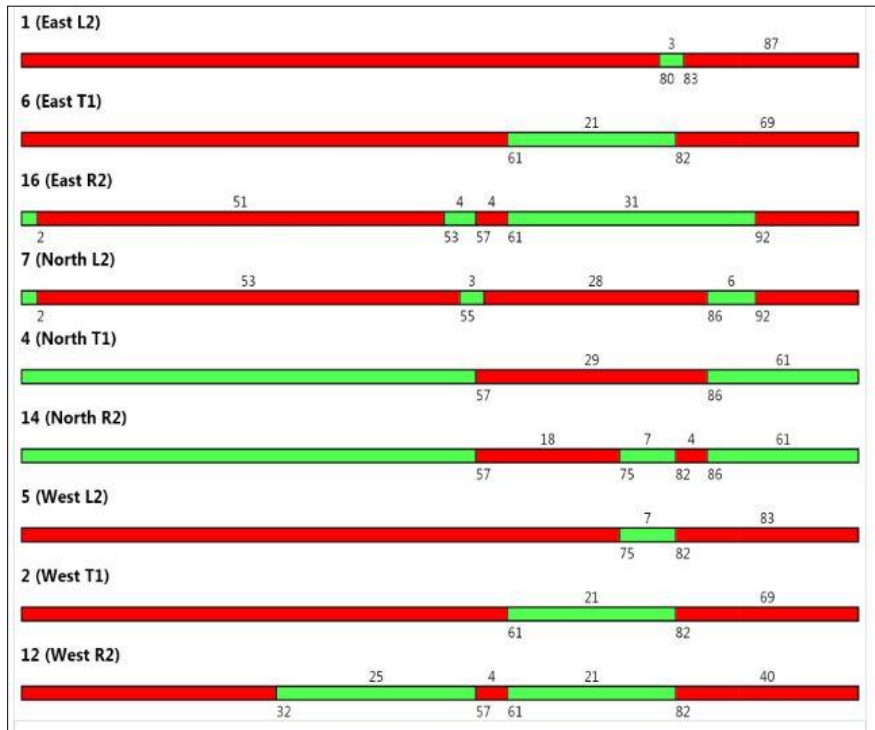
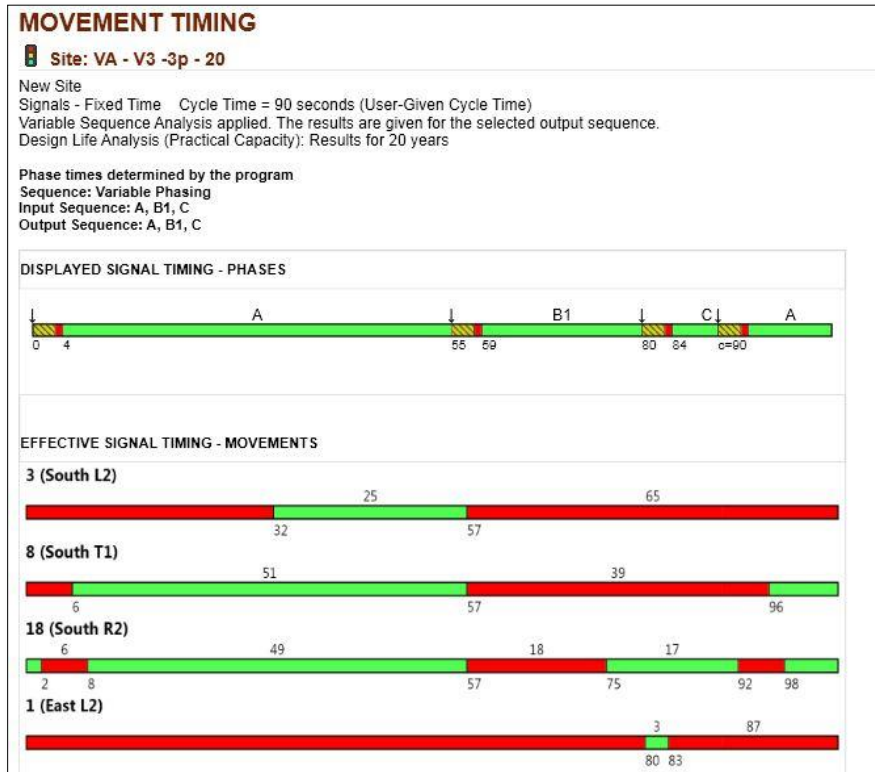

Appendix 6. Movement timing of VB_II-20.



Appendix 7. Movement timing of VA_III-3P for existing network

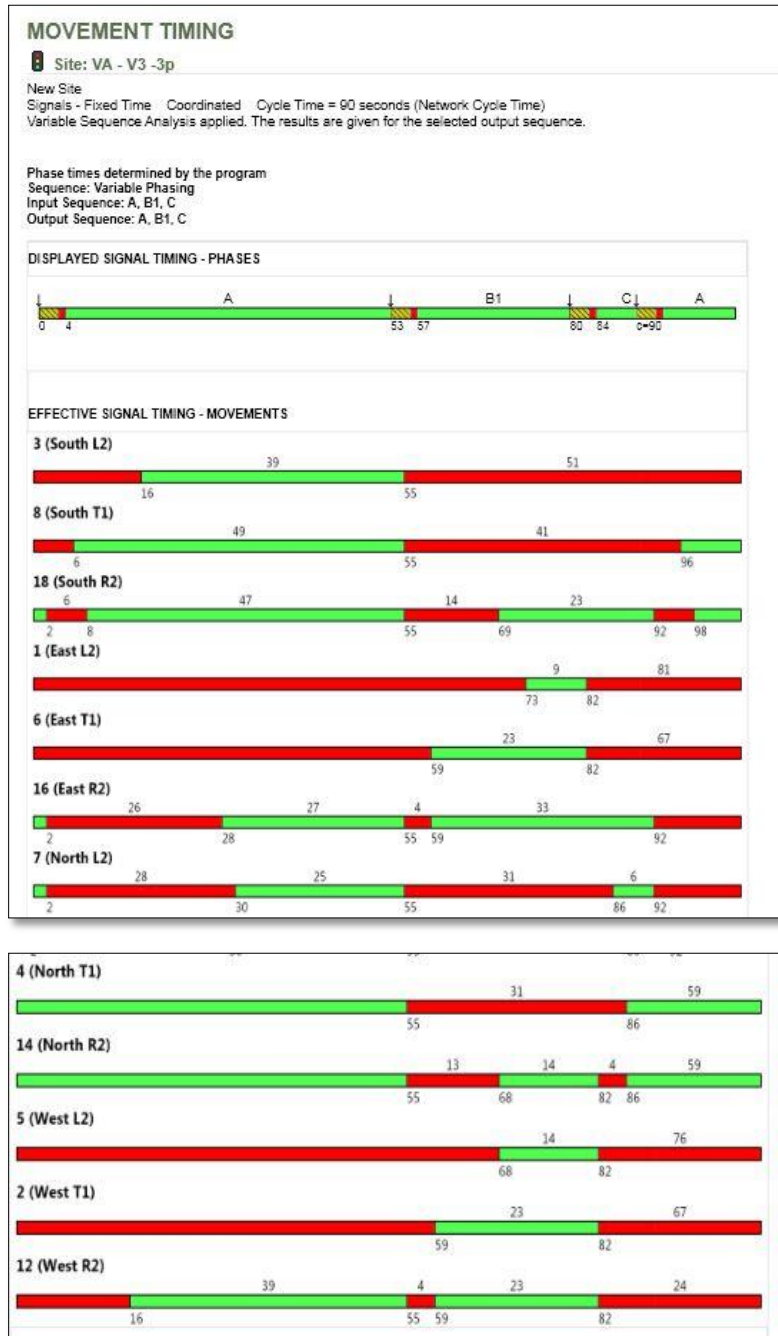

Appendix 8. Movement timing of VB-I for existing network.



Appendix 9. Movement timing of VB-I for a design period of 20 years.

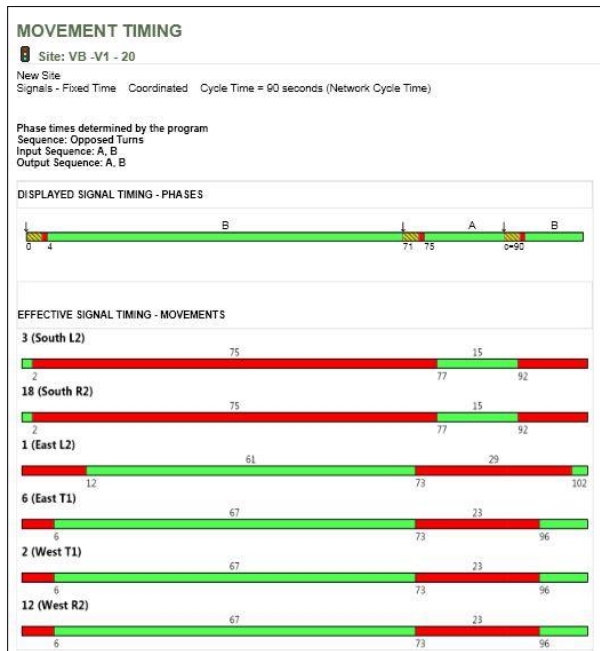

Appendix 10. Movement timing of VA-III-3P-20 for a design period of 20 years.

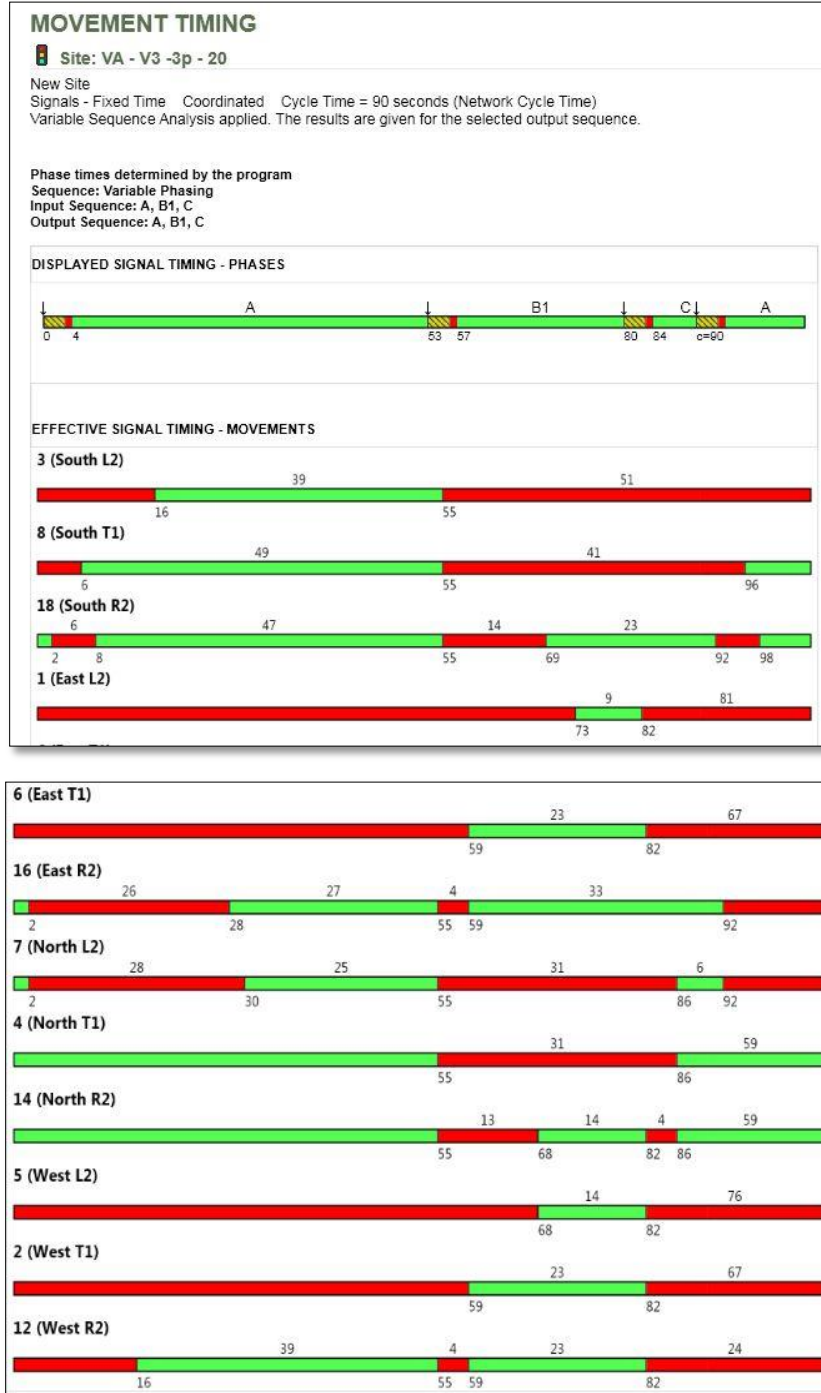

Appendix 11. Traffic counting slip for intersection Donje-Svetice and Planinska Street.

COUNTING SLIP																	
Name of intersection: Donje-Svetice and Planinska Street (Planinska Street West/East)													Date/hours: 9/02/2016(07:00-08:00)				
approach	4 - 1				4 - 3				4 - 2				4 - 1,3,2				total [veh/h]
type of vehicles	motor-cycle	personal vehicles	heavy vehicles	bus	motor-cycle	personal vehicles	heavy vehicles	bus	motor-cycle	personal vehicles	heavy vehicles	bus	motor-cycle	personal vehicles	heavy vehicles	bus	
0' -- 15'		3	3			65	3	1		17	1		0	85	7	1	101
16' -- 30'		5	1			51	7	3		17			0	73	8	3	95
31' -- 45'		7	2			44	4	3		20	3		0	71	9	3	95
46' -- 60'		6				40	8	1		23	3		0	69	11	1	93
TOTAL HOUR		21	6			200	22	8		77	7		0	298	70	16	384
approach	3 - 2				3 - 4				3 - 1				3 - 2, 4, 1				total [veh/h]
type of vehicles	motor-cycle	personal vehicles	heavy vehicles	bus	motor-cycle	personal vehicles	heavy vehicles	bus	motor-cycle	personal vehicles	heavy vehicles	bus	motor-cycle	personal vehicles	heavy vehicles	bus	
0' -- 15'		2				58		2		49	1		0	109	1	2	115
16' -- 30'		1	1		1	46	1	2		46	1		1	93	3	2	103.5
31' -- 45'		4	1			48	1	2		45	3		0	97	5	2	111
46' -- 60'		9				51	3	3		54	5		0	114	8	3	136
TOTAL HOUR	0	16	4	0	0.5	203	10	18	0	194	20	0	0.5	413	34	18	465.5

COUNTING SLIP																	
Name of intersection: Donje-Svetice and Planinska Street (Donje-Svetice Street South/North)													Date/hours: 9/02/2016(07:00-08:00)				
approach	2 - 4				2 - 1				2 - 3				2 - 4,1,3				total [veh/h]
type of vehicles	motor-cycle	personal vehicles	heavy vehicles	bus	motor-cycle	personal vehicles	heavy vehicles	bus	motor-cycle	personal vehicles	heavy vehicles	bus	motor-cycle	personal vehicles	heavy vehicles	bus	
0' -- 15'		16	1			100	5	1		6			0	122	6	1	136
16' -- 30'	1	15				137	16			8	1		1	160	17	0	194.5
31' -- 45'		7				115	16			5	2		0	127	18	0	163
46' -- 60'		14				132	13			6			0	152	13	0	178
TOTAL (veh/h)	0.5	52	2	0	0	484	100	2	0	25	6	0	0.5	561	108	2	671.5
approach	1 - 3				1 - 2				1 - 4				1 - 3,2,4				total [veh/h]
type of vehicles	motor-cycle	personal vehicles	heavy vehicles	bus	motor-cycle	personal vehicles	heavy vehicles	bus	motor-cycle	personal vehicles	heavy vehicles	bus	motor-cycle	personal vehicles	heavy vehicles	bus	
0' -- 15'		20				146	4	1		7			0	173	4	1	183
16' -- 30'	1	15	1			171	8			8			1	194	9	0	212.5
31' -- 45'		7				139	8			6	2		0	152	10	0	172
46' -- 60'		17				152	7			8			0	177	7	0	191
TOTAL (veh/h)	0.5	59	2	0	0	608	54	2	0	29	4	0	0.5	696	60	2	758.5

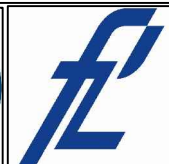
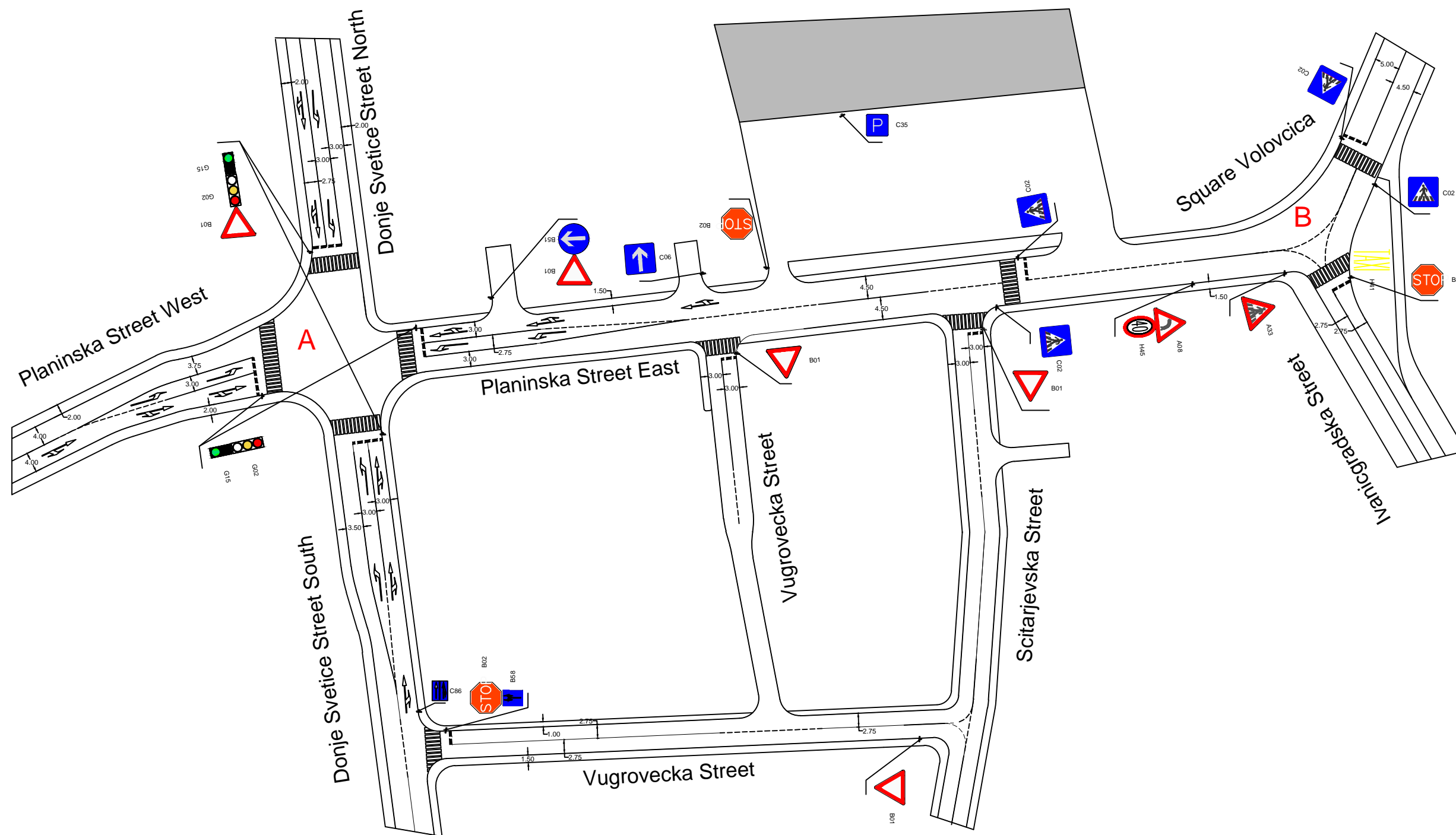

University of Zagreb
 Faculty of Transport and Traffic Sciences
 Department of Road Transport

Variante VA_0. : existing design of
 Planinska Street and Donje Svetice
 Street

Drawn by :	Name Surname
IMBAG :	Arun Gurung
Mentor :	0135239941
	Hrvoje Pilko, Ph.D.

M 1:1000

SHEET NO : I

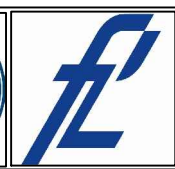
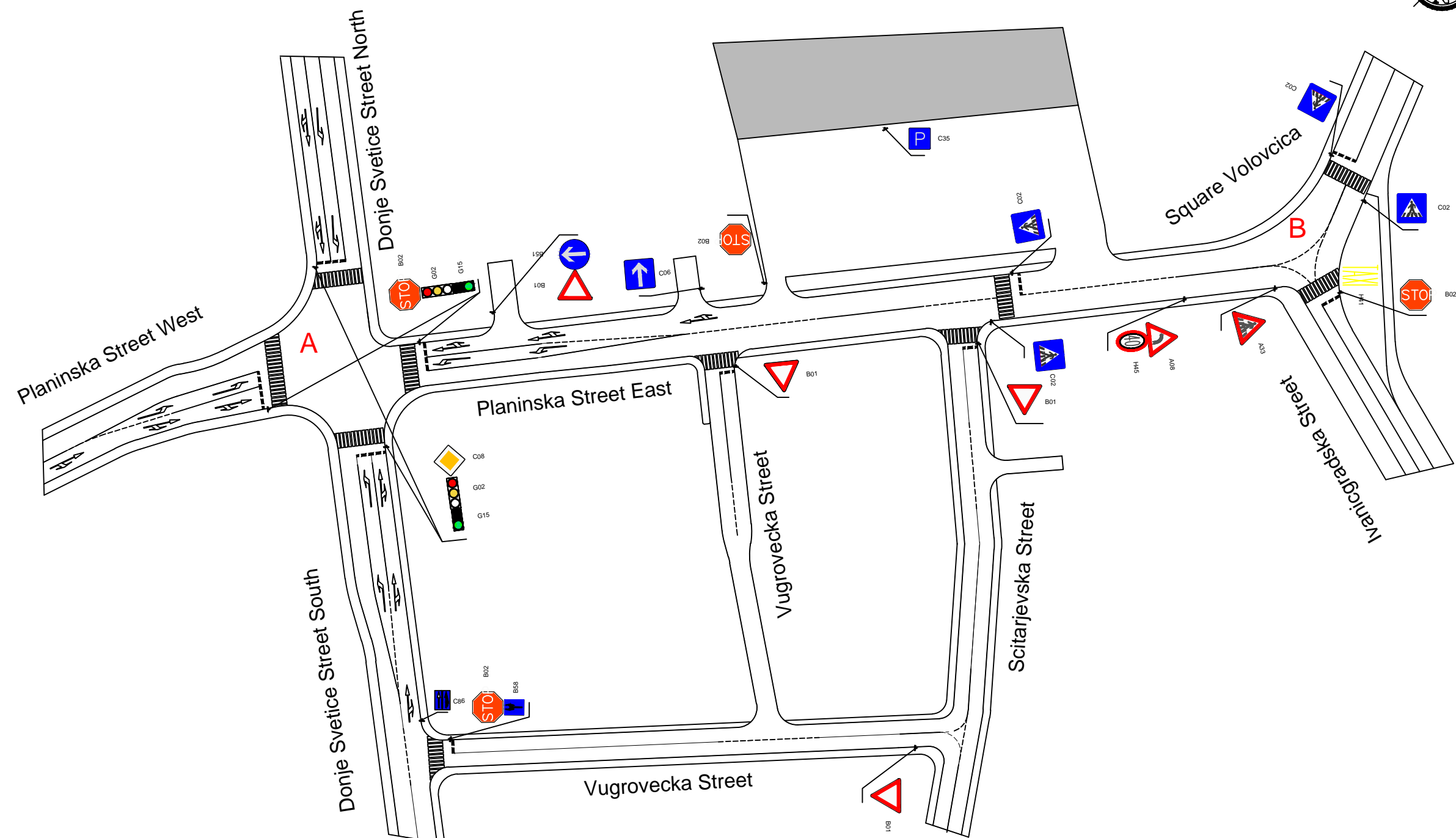

University of Zagreb
 Faculty of Transport and Traffic Sciences
 Department of Road Transport

Variet VA_I. : introduction of three phase
 traffic signal plan

Name Surname	M	1:1000
Drawn by : Arun Gurung	SHEET NO : III	
IMBAG : 0135239941		
Mentor : Hrvoje Pilko, Ph.D.		

SHEET NO : III

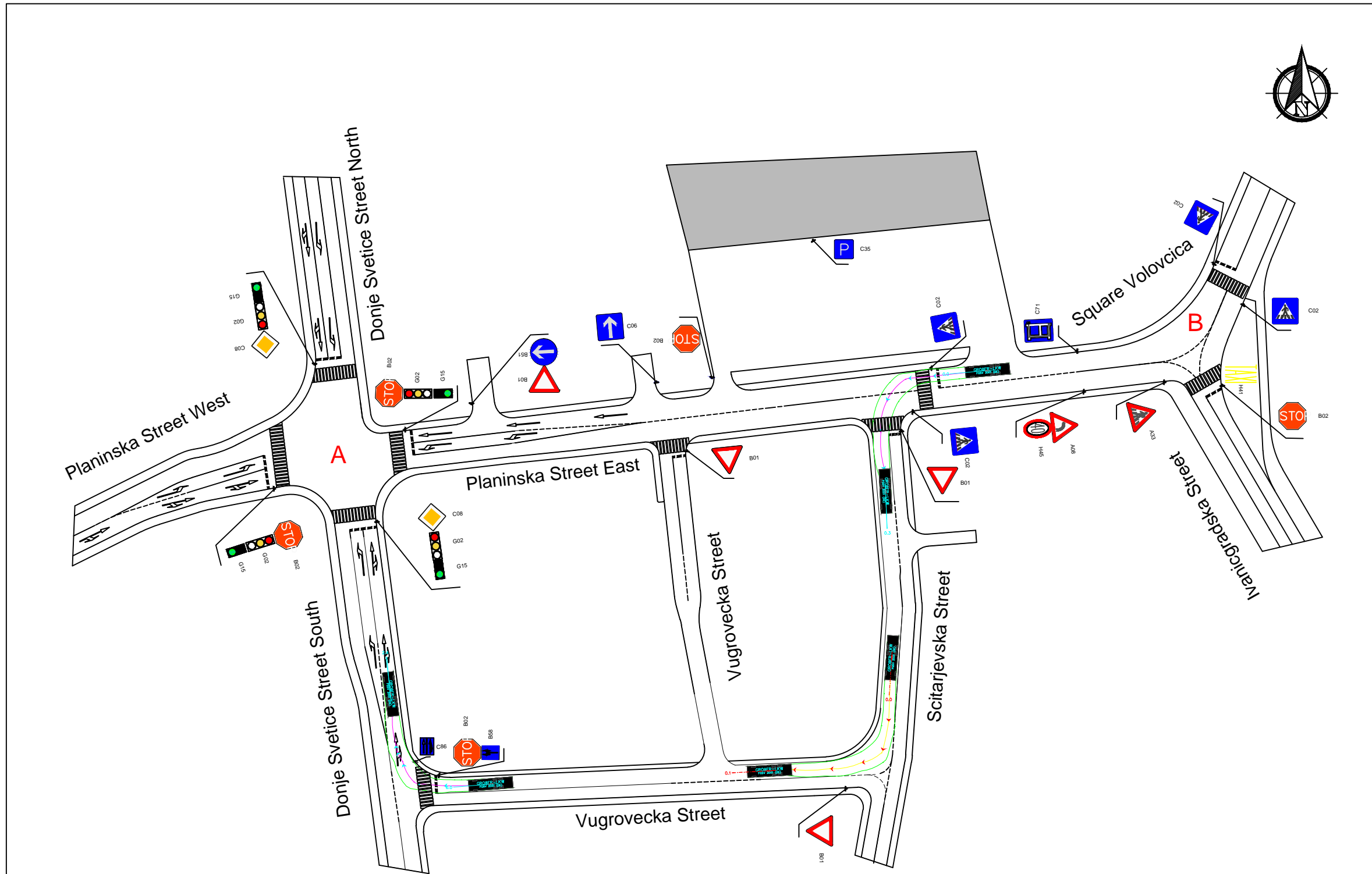

University of Zagreb
 Faculty of Transport and Traffic Sciences
 Department of Road Transport

Variet VA_II. : re-routing of the right hand traffic of Planinska Street East through Scitarjevska Street and Vugrovecka Street

	Name Surname	M	1:1000
Drawn by :	Arun Gurung		
IMBAG :	0135239941		
Mentor :	Hrvoje Pilko, Ph.D.	SHEET NO : II	

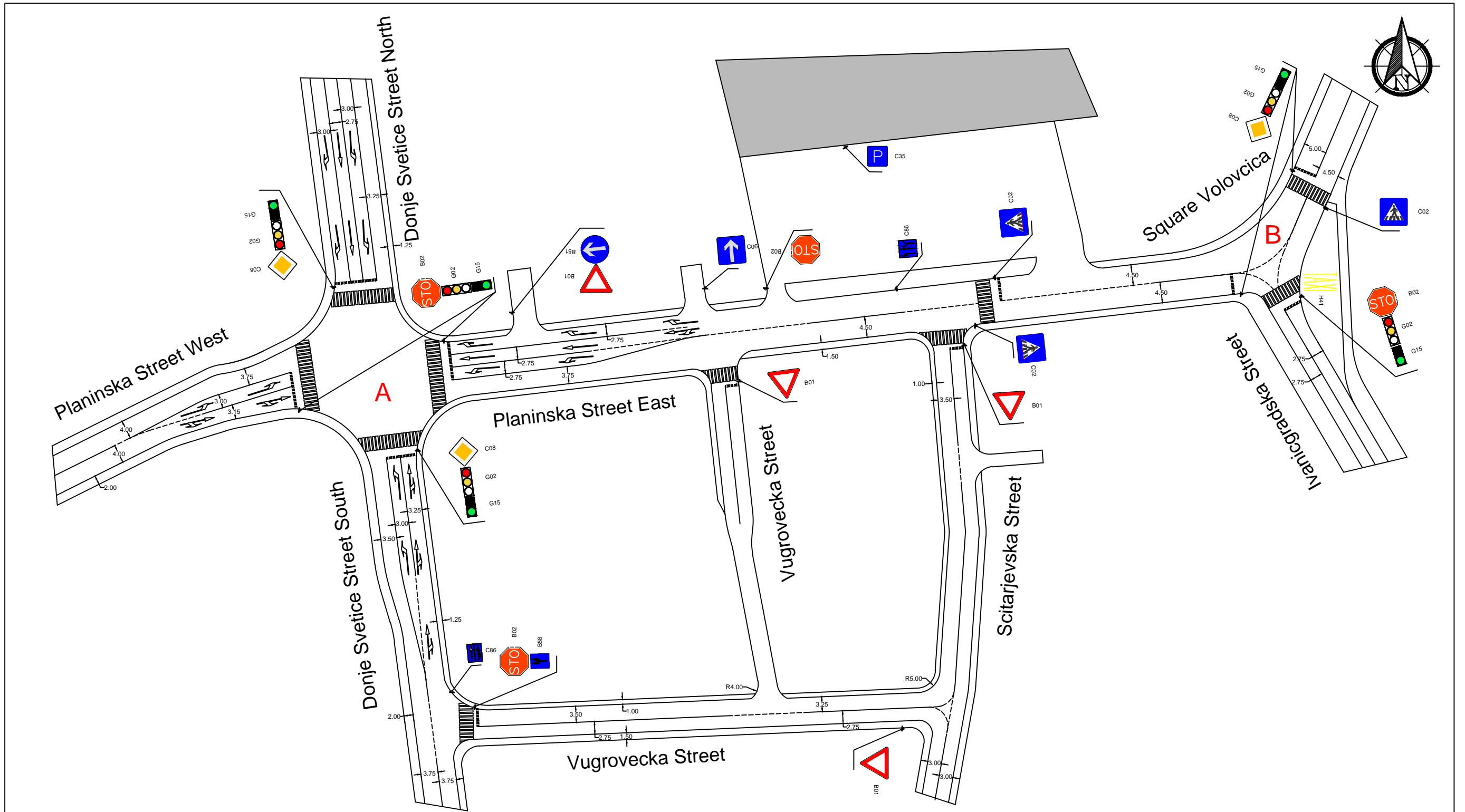

University of Zagreb
 Faculty of Transport and Traffic Sciences
 Department of Road Transport

Variet VA_III. : addition of one traffic lane on Planinska Street East and Donje Svetice Street North

Drawn by :	Name Surname
IMBAG :	Arun Gurung
Mentor :	0135239941
	Hrvoje Pilko, Ph.D.

M	1:1000
SHEET NO : IV	

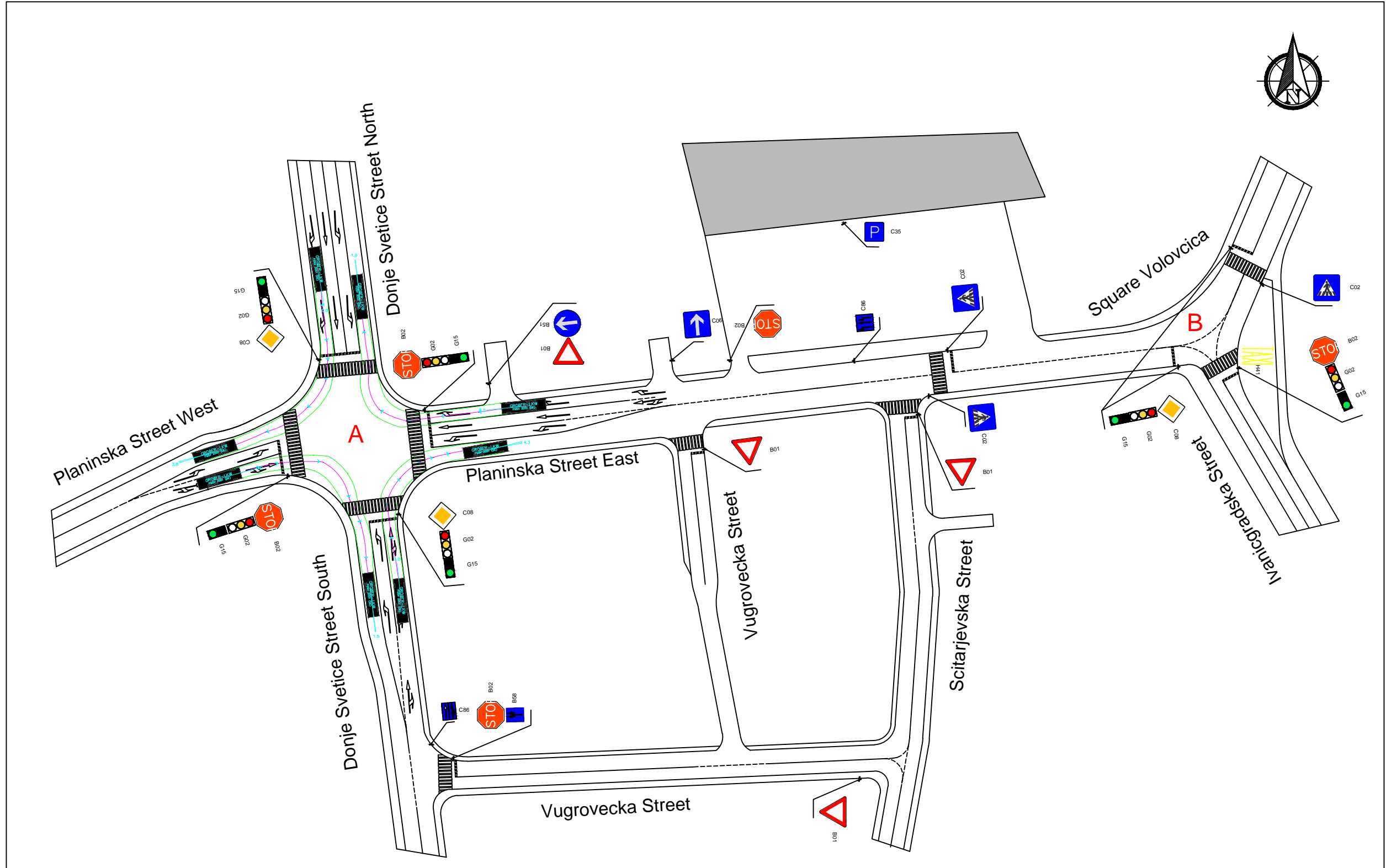

University of Zagreb
 Faculty of Transport and Traffic Sciences
 Department of Road Transport

Variet VA_III. : addition of traffic lane
 on Planinska Street East and Donje
 Svetice Street North

	Name Surname
Drawn by :	Arun Gurung
IMBAG :	0135239941
Mentor :	Hrvoje Pilko, Ph.D.

M	1:1000
SHEET NO : IV	